

**Handbook for the Operation of
Water Treatment Works**
Frik Schutte (Editor)



TT 265/06



Water Research Commission

HANDBOOK FOR THE OPERATION OF WATER TREATMENT WORKS

**The Water Research Commission
The Water Institute of Southern Africa**

Editor:

**Frik Schutte
Water Utilisation Division
Department of Chemical Engineering
University of Pretoria**

TT 265/06

MARCH 2006

Obtainable from:

Water Research Commission
Private Bag X03
Gezina
0031

The publication of this report emanates from a project entitled: *Development of a handbook for the operation of water treatment works*
(Consultancy No 559)

DISCLAIMER

This report has been reviewed by the Water Research Commission (WRC) and approved for publication. Approval does not signify that the contents necessarily reflect the views and policies of the WRC, nor does mention of trade names or commercial products constitute endorsement or recommendation for use.

ISBN 1-77005-428-6

Printed in the Republic of South Africa

Cover photographs courtesy of Rietvlei Water Treatment Works

TABLE OF CONTENTS

PURPOSE OF THE HANDBOOK	1
WHO SHOULD USE THE HANDBOOK	2
 PART A: BACKGROUND	
1. Introduction to water quality and treatment	3
2. Drinking water quality	25
3. Introduction to Water Chemistry	38
4. Water treatment calculations	58
 PART B: TREATMENT PROCESSES	
1. Coagulation-flocculation	70
2. Sedimentation and flotation	87
3. Sand filtration	98
4. Disinfection	117
5. Chemical stabilisation	145
6. Fluoridation	158
7. Residuals handling and treatment	164
8. Advanced processes	172
 PART C: MANAGEMENT AND CONTROL	
1. General management concepts	193
2. Treatment plant control	200
3. Maintenance and trouble shooting	219
4. Safety	227
 PART D: APPENDICES AND REFERENCES	
References	232

PURPOSE OF THE HANDBOOK

The treatment and supply of drinking water is a challenging task that includes many diverse aspects ranging from water quality management in catchments, operation and control of water treatment plants, distribution of treated water, community participation, project management, etc. The purpose of this handbook is to provide comprehensive information specifically on all aspects related to the **treatment** of water for domestic use. The focus is on the **operational aspects** of treatment plants and processes and not on process design. Sufficient background and process descriptions are provided to enable a proper understanding of the functioning of the different processes and on aspects such as the suitability of processes for different types of water and the limitations of different processes.

The purpose of this Handbook is **not** to provide an instruction manual or task list for process controllers or operators to operate unit processes or a treatment plant. A handbook in the form of an illustrated operational guide is being prepared for the WRC for this purpose.

The objective of this Handbook is to provide the plant supervisor and process controller with sufficient knowledge and insight to:

- Assess raw water quality as well as the quality of water from individual unit processes and the treatment plant as a whole to ensure that final water of the required quality is produced
- Understand the implications to consumers and other stakeholders if sub-standard water is produced and supplied
- Calculate and make adjustments to dosages and operating parameters in response to changes in raw water quality or other requirements
- Assess the performance of unit processes and the plant as a whole
- Identify potential causes of poor performance of unit processes
- Optimise the performance of unit processes and the plant as a whole
- Perform basic management tasks including water loss assessment and control and safety management

The authors recognise that the majority of plant operators currently in operating positions might find the level of material in this Handbook too advanced and would encourage them to use the illustrated handbook mentioned above. However, the authors feel that wherever possible plant operators should be encouraged to improve their knowledge and qualifications and this Handbook should be useful for that purpose.

The layout of this Handbook is such that some aspects are repeated in different sections. Many aspects covered in Part A (e.g. in Overview of Treatment Processes and in Water Chemistry) are discussed again in Part B (Treatment Processes). This duplication is beneficial to the reader since the focus of the different sections is different and the same material is presented from different perspectives.

This is a first attempt at developing a Handbook specifically for the operation of drinking water treatment plants to match the Handbook for the Operation of Wastewater Treatment Works. The initiatives of the Water Research Commission (WRC) and the Water Institute of Southern Africa (WISA) are recognised to have the Handbook developed. Some sections in this Handbook are similar to certain sections in the Wastewater Handbook because the subject material of the basic aspects is very similar. A number of reference books has been used in the compilation of the subject material and they are listed in the reference section.

The study material has been compiled by experts in the field with many years of experience in the field of drinking water treatment. However, it is recognised that the Handbook may have shortcomings from the perspective of process controllers and operators who may have specific requirements not adequately addressed by the book. For this reason Handbook users are requested to submit any suggestions for improvement of future editions to the Water Research Commission or WISA or any of the authors.

WHO SHOULD USE THE HANDBOOK?

The level of presentation in this Handbook is on the BSc. and BTech. level, i.e. suitable for training of process controllers and treatment plant operators at **tertiary training level**. Some parts of the Handbook will be useful for in-house training of treatment plant operators and process controllers. The Handbook provides basic information on water treatment processes and water supply that should also be useful for other people involved in water treatment and water supply, including engineers and scientists. The groups who may find the Handbook useful include:

- Water treatment plant supervisors and managers
- Water treatment plant process controllers
- Engineers and scientists involved in water treatment and supply
- Educators and students

PART A: BACKGROUND

CHAPTER A1: INTRODUCTION TO WATER QUALITY AND TREATMENT

Frik Schutte

INTRODUCTION

The term “water quality” describes the physical, chemical and microbiological characteristics of water. These properties collectively determine the overall water quality and the fitness of the water for a specific use. These properties are either intrinsic to the water or are the result of substances that are dissolved or suspended in the water.

Water quality is only meaningful when evaluated in relation to the use of the water. The reason is that water of a certain quality may be fit for a specific use, but completely unfit for another use. For example, water that is fit for human consumption may not be fit as boiler feed water because the dissolved inorganic salts that are acceptable in drinking water, are not tolerated in boiler feed water, since they may precipitate and cause blockages in the boiler equipment.

Water that is fit for domestic use (drinking water) must comply with specific requirements. The most important requirement is that it must be **safe to drink**. Many raw water sources contain harmful micro-organisms or other substances in concentrations that make the water unsafe to drink or in other ways unfit for domestic use. These organisms and substances must be removed from the water by means of treatment processes to make the water fit for domestic use. In addition to the requirement that water must be safe to drink, water for domestic use must also be **aesthetically pleasing** (have a clean appearance, taste and odour) and it must furthermore be **chemically stable** (i.e. it must not cause corrosion or form deposits in pipes or fixtures such as geysers).

The principal objective therefore of water treatment is to produce water that is fit for domestic use reliably and consistently from a raw water source at a cost that is reasonable to the consumers. A water treatment plant employs many individual treatment processes (sometimes called unit processes and unit operations) that are linked in a process train to produce water of the desired quality.

In this chapter a brief overview is given of historic developments in water treatment, followed by a discussion of water quality aspects that are relevant to drinking water treatment. This is followed by an overview of the different treatment processes commonly used for water treatment and the processing of residuals. Each of these processes is discussed in detail in subsequent chapters in the Handbook.

HISTORIC DEVELOPMENTS

The first references to clean water or 'sweet water' and for water to be good for use after passage over a certain number of stones date back about 3000 years to Biblical times. The Roman aqueducts are well-known later landmarks in Europe as testimony of conveying clean water to cities. By the eighteenth century the removal of particles from water by filtration was known as an effective way of clarifying water and the first municipal water filtration plant started operating in Scotland in 1832. However, the main objective at that time was simply to supply clear water because the germ theory and the knowledge that diseases could be spread by water was still unknown. It was only in 1855 that Dr John Snow, an epidemiologist showed empirically that a cholera outbreak in London was caused by drinking water contaminated by faecal wastes from a cholera patient. However, the concept of disinfection as a disease preventing measure and a practical disinfection process only developed much later. Pasteur demonstrated his germ theory only in the 1880's and chlorination as treatment process was developed after 1905.

By the early 1900's the large increase in the number of water supply systems without proper treatment in the USA contributed to major outbreaks in water-borne diseases. However, it was only with the introduction of chlorine as a treatment process to disinfect water in 1908 that the spreading of diseases through contaminated water could be controlled. Chlorination was rapidly accepted as an essential part of water treatment and this resulted in a substantial decline in the number of deaths due to water-borne diseases.

Research on coagulation-flocculation, sedimentation and filtration as basic water treatment processes during the early part of the previous century contributed to a better understanding of these processes and much improved performance. New processes were also developed during that time in Europe. The use of ozone for disinfection and taste- and colour enhancement was introduced early in the century in France and Germany.

The most significant process development since the introduction of chlorine during the previous century was the development of synthetic membranes as treatment process. The first practical reverse osmosis membranes for the desalination of seawater were developed in the 1960's. Later, other types of membranes were developed, including nanofiltration (NF), ultrafiltration (UF) and microfiltration (MF) membranes. These membranes find application in water treatment other than just desalination. For example, NF and UF membranes are used to replace some conventional treatment processes for removal of natural organic substances and micro-organisms from water.

In South Africa water treatment and supply followed the pattern of the western world and in some aspects South Africa actually lead the way. For example, the concepts of water reclamation and reuse were pioneered in South Africa and Namibia. South Africa is also known as a world leader in the field of biological nutrient removal in advanced wastewater treatment.

Sadly, the supply of clean and safe water in South Africa was until recently limited to formal municipalities. Most rural areas and many townships had no (or limited) water

supply and poor sanitation. In many rural areas in the country water is abstracted from a river, stream, borehole or well and consumed without any treatment or with only limited treatment. In these situations, the health of consumers is often at risk. Often the erection of a conventional treatment plant and the effective running of such processes may not be possible in many rural areas and alternative approaches have to be followed.

The situation with respect to water supply has however, improved dramatically over the last number of years and it is a clear objective of government (and it is stated as a basic human right in the RSA Constitution) that every citizen must have access to clean water and basic sanitation. Many ambitious programmes are currently under way for water supply and sanitation in previously disadvantaged communities and in rural areas.

The result of these developments is that the need for engineers and trained operators and process controllers has increased and special efforts are needed to provide appropriately trained people at all levels in the water treatment and supply industry.

The main challenges facing the water industry today include:

- Deterioration in the quality of many raw water sources
- Removal of potentially harmful synthetic organic substances in water sources
- Removal of resistant micro-organisms from water
- Improved training of process controllers for new processes and process optimisation
- Demands for process integration and flexibility

WATER QUALITY

General aspects of water quality

Water is a unique substance and one of its unique characteristics is its capacity to dissolve a variety of substances. As water moves through its cycle, called the hydrological cycle, comprising of rainfall, runoff, infiltration, impounding, use and evaporation, it comes into contact with many different substances that may be **dissolved** by the water to a greater or lesser extent or that may be **suspended** in the water. The type and amount of the dissolved substances together with suspended and colloidal substances (very small suspended particles) collectively determine the overall quality of the water and its fitness for domestic use.

The **types of contaminants** or **substances of concern** that may occur in water sources vary over a wide spectrum and include inorganic salts, micro-organisms, clay particles and organic material. Those with similar characteristics that can be treated by the same type of treatment process are normally grouped together for design purposes and for general discussion. It is normally not possible to consider each individual substance of concern with the view to treatment. There are exceptions, however, for example the removal of a toxic substance from water is often specific for the particular substance.

The substances of concern in water can be categorised in different ways, e.g. as dissolved or suspended, as inorganic or organic, as macro or micro substances, as natural or synthetic substances, suspensions of micro-organisms etc. For the purpose of this discussion the characteristics of different groups of substances that are treated by the same types of processes will be considered briefly

Dissolved substances

Most substances are to a greater or lesser extent dissolved by water. Substances that are dissolved by water include *gasses* such as oxygen (O₂), carbon dioxide (CO₂) and ammonia (NH₃), *inorganic compounds* such as sodium chloride (NaCl) and calcium sulphate (CaSO₄) and *organic substances* such as humic acids and carbohydrates. Dissolved substances are generally more difficult to remove from water than suspended substances, since they must either be converted into the solid form by means of precipitation, or to the gas form by means of oxidation so that the gas can escape or be stripped from water. A further possibility to remove dissolved substances is by using advanced processes such as reverse osmosis or activated carbon adsorption.

Suspended and colloidal substances

In addition to the substances that are dissolved in water, some substances may not dissolve in water but remain in suspension as very small *suspended or colloidal particles*. Suspended solids are defined as solids that are relatively large and settle easily under quiescent conditions. Suspended solids are normally determined by filtering the suspended solids from a water sample of known mass, and determining the mass of the dried solids.

Colloidal particles on the other hand are too small to settle and they also carry an electrical charge that prevents them from settling. They can actually remain in suspension for days without settling.

A colloidal system is defined as a system in which particles in a finely divided state are dispersed in a continuous medium. Colloidal particles are not limited to any particular group of substances but are defined by size. The colloidal size range is generally regarded to extend in size from about 10 nanometer (nm) to 1 micrometer (µm).

Colloidal particles impart undesirable properties to water:

- Turbidity is most often caused by inorganic clay minerals in surface water. Most turbidity particles are hydrophobic (water repelling) and range in size from 0.2 to 10 µm. Turbidity can be readily removed from water by coagulation-flocculation and separation.
- Colloidal organic substances, i.e. humic and fulvic acids with molecular mass ranging between 800 and 50000 Daltons (Mol Mass units) generally cause colour in natural water. Colloidal metal hydroxides (e.g. iron) also cause colour in water. Most of the particles responsible for colour are hydrophilic (water attractive) and more difficult to remove by coagulation than turbidity particles.

- Bacteria, viruses and micro-algae are also colloidal in nature. They consist of polar organic molecules, are hydrated and hydrophilic.
- Certain complex organic compounds in treated industrial wastewater can also be considered as colloidal.

Colloidal suspensions are stable and must be destabilised before it is possible to aggregate them into bigger floc particles that can be removed by sedimentation and filtration. Destabilisation is effected by coagulation, and aggregation by flocculation. These processes are discussed in detail in subsequent chapters.

CHEMICAL WATER QUALITY

Dissolved organic and inorganic substances determine the chemical quality of water. These substances have a wide range of effects on the chemical properties of the water. For example, some of these substances can be toxic (chromium, arsenic), while other cause the water to be hard or scale forming (calcium carbonate), and other chemical compounds may affect the taste and odour of the water (sodium chloride, geosmin).

A large range of *inorganic chemical* compounds can be present in water. These compounds such as sodium chloride, NaCl and calcium sulphate, CaSO₄ dissolve in water in the form of the respective ions, i.e. Na⁺, Ca²⁺, Cl⁻ and SO₄²⁻. A chemical analysis of the water gives the concentration of individual ions, normally in mg/l. The total quantity of dissolved inorganic compounds in water is expressed as the concentration of Total Dissolved Inorganic Solids (TDIS or more commonly TDS) in mg/l. An indication of the TDS is given by the Electrical Conductivity (EC) of the water, as is discussed below under physical properties.

A full inorganic chemical analysis of raw water and final treated must be performed at regular intervals to determine whether any compounds are present in the raw water at concentrations that may be a cause for concern. A full analysis of the raw water must be performed at least once per year while the analysis on treated water must be in accordance with the specification or guidelines prescribed for the treatment plant (SABS 241, DWAF Water Quality Guidelines for Domestic Use)

A very large variety of *organic substances* can be present in water. These substances may either be natural substances such as decaying plant material, algal or bacterial by-products and carbohydrates, or synthetic compounds such as pesticides, herbicides and solvents as well as products formed during water treatment such as chloroform and other chlorinated products. There are many thousands of organic compounds that have been identified in water, most of them at very low concentrations.

Organic compounds have carbon as a main element in their composition and most of them do not go into solution as ions but go into solution as molecules of the compound. Organic compounds are determined either collectively by means of oxidation, as individual compounds or as groups of compounds.

An indication of the general organic quality of the water can be obtained by means of the determination of cumulative parameters such as:

- Total organic carbon (TOC)
- Dissolved organic carbon (DOC)
- Chemical oxygen demand (COD)
- Biological oxygen demand (BOD)

Individual organic compounds or groups of compounds are generally determined by gas chromatography and mass spectrophotometry (GC-MS) or by other specialised methods.

One of the organic groups of compounds of particular interest in drinking water treatment is the so-called Trihalomethanes, expressed in $\mu\text{g/l}$ THM. This group includes compounds such as chloroform (CHCl_3) and related compounds.

Other chemical water quality parameters

There are a number of collective water chemical parameters specific to water treatment. These include alkalinity, hardness, chemical stability, free available - and combined chlorine species.

Alkalinity of water is a measure of its acid-neutralising capacity. Alkalinity plays an important role to buffer water and prevent changes in pH due to addition of acid, or acid-producing chemicals such as ferric chloride. Alkalinity is determined by the concentration of carbonate, bicarbonate and hydroxide species in the water and by the pH. Different forms of alkalinity are distinguished by titrating the water to different specific end points. Total alkalinity (also known as the Carbonic Acid Alkalinity) is determined by titrating with a strong acid to a pH end point of 4,5. Phenolphthalein alkalinity (also known as bicarbonate alkalinity) is determined by titrating a water sample to the phenolphthalein end point of pH 7.8. (See Chapter A3 Introduction to Water Chemistry for a detailed discussion).

The **hardness** of water is determined by the concentration of divalent cations in the water, mostly calcium and magnesium and is expressed as mg/l CaCO_3 . Hardness affects the lather-forming ability of water with soap. Different forms of hardness can be distinguished (see Chapter A3) all expressed as mg/l CaCO_3 :

- *carbonate or temporary hardness*, which is caused by calcium and magnesium associated with bicarbonate in the water
- *non-carbonate or permanent hardness*, which is caused by calcium and magnesium associated with ions other than bicarbonate such as chloride and sulphate,
- *calcium hardness*, caused by all the calcium ions in solution,
- *magnesium hardness*, caused by all the magnesium ions in solution, and
- *total hardness*, which is the sum of calcium and magnesium hardness.

Table A1.1 gives an indication of classification of waters in terms of hardness:

Table A1.1: Hardness classification

Hardness classification	Total hardness as mg/l CaCO ₃
Soft	Less than 50
Reasonably soft	50 to 100
Slightly hard	100 to 150
Reasonably hard	150 to 250
Hard	250 to 350
Very hard	More than 350

The **chemical stability** of water is a very important characteristic since it determines whether water will be chemically stable, aggressive-corrosive or scale forming. This has very important cost implications for maintenance of distribution systems. If water is supersaturated with respect to calcium carbonate, the calcium carbonate will precipitate and form a layer of chemical scale on the surface of pipes and fixtures. A thin layer of calcium carbonate affords protection against corrosion, while excessive precipitation reduces the carrying capacity of pipes and may even lead to blocking of pipes in extreme cases.

On the other hand, if water is under-saturated with respect to calcium carbonate, any layer that may have precipitated will dissolve leaving the metal or other pipelining material exposed and subject to chemical attack (e.g. corrosion). It is therefore advisable to treat water to a slight super-saturation for protection against corrosion.

There are different methods to express chemical stability. The indices that have been used generally are the *Langelier saturation index (LSI)* and the *Ryznar stability index (RI)*. These indices are qualitative in nature and therefore do not provide adequate information.

A quantitative, and therefore more satisfactory way of determining the chemical stability of water is to calculate the calcium carbonate precipitation potential of the water. **Calcium Carbonate Precipitation Potential (CCPP)** is a parameter that gives the actual mg/l of CaCO₃ that would theoretically precipitate from the water. A positive CCPP of about 4 mg/l has been shown to give adequate protection against corrosion without excessive CaCO₃ precipitation.

The determination of CCPP has been made very simple by using the **Stasoft computer program** that is available from the Water Research Commission (See Chapter on Stabilisation).

Residual chlorine

Chlorine is the most generally used agent to disinfect water. Stringent control of the amount of chlorine dosed and the residual chlorine concentration after a certain contact time is necessary to ensure microbiologically safe water. Chlorine gas (Cl₂) dissolves in water to form hypochlorous and hydrochloric acid. The actual disinfecting agent is hypochlorous acid which dissociates to form the hypochlorite ion, OCl⁻.

The amount of hypochlorous acid (HOCl) together with hypochlorite ion (OCl⁻) is termed **free available chlorine**. The residual of free available chlorine must generally be 0,5 mg/l after a contact time of 30 minutes to ensure properly disinfected water. The C.t concept (residual concentration multiplied by contact time) is discussed in detail in the chapter on Disinfection.

Chlorine in the form of monochloramine (together with other chloramine species) termed combined available chlorine) is also used for water disinfection. It is formed when chlorine is added to water that contains a small amount of ammonia. The ammonia reacts with HOCl to form monochloramine, NH₂Cl. It is much less effective as a disinfectant than HOCl (the same order of effectiveness as chlorite ion). However, it has the advantage of being much more stable in water than free available chlorine. For this reason it is often used to provide residual protection in larger distribution systems.

PHYSICAL WATER QUALITY

The physical quality of water is determined by intrinsic characteristics as well as by dissolved and colloidal substances in the water. Intrinsic physical properties include temperature, viscosity, and surface tension. Other physical properties such as electrical conductivity, colour, taste and odour are determined by the presence of dissolved and colloidal substances in the water. Some characteristics of water are often indicated as physical characteristics, while they are in actual fact chemical in nature, pH being an example. These properties can also be called physico-chemical properties. The general physical properties of water that play a role in treatment are discussed in the following section.

Turbidity gives an indication of the concentration of colloidal particles in water. Turbidity is expressed in nephelometric turbidity units, NTU. It is determined in a Nephelometer by comparing the intensity of light scattered by the water sample to the intensity of light scattered by a standard reference in the turbidity meter. The turbidity of raw water can be as low as a 1 or 2 NTU in groundwater and up to several hundred in turbid surface water, e.g. after a rain storm. The turbidity of drinking water should be <1, and preferably <0,1 NTU.

The **pH** of water is measured in pH units. The pH value is a measure of the concentration of hydrogen ions, [H⁺] in the water expressed as a logarithmic value. The pH gives an indication of how acidic or basic the water is.

Because the concentration of [H⁺] and [OH⁻] can vary over the very wide range of 10⁰ to 10⁻¹⁴ it is convenient to use a logarithmic scale to express the concentration. For this purpose the pH function was introduced as:

$$\text{pH} = -\log [\text{H}^+]$$

where [H⁺] is the hydrogen ion concentration expressed in moles/l.

Because the pH scale is logarithmic, it means that a change of one pH unit is equal to a 10 times increase in $[H^+]$ concentration (See Appendix A1 for a more detailed discussion).

Electrical conductivity is a measure of the ability of the water to conduct an electric current. Since the electric current is conducted through the movement of ions in solution, EC also gives an indication of the concentration of the ions or total dissolved solids (TDS) in the water. Electrical conductivity (EC) of water is measured in units of milli Siemen per metre (mS/m). Other units that are also used include $\mu\text{S}/\text{cm}$, which is numerically equal to $\mu\text{mho}/\text{cm}$.

Conversion from $\mu\text{S}/\text{cm}$ to mS/m is as follows:

$$\text{mS/m} = \mu\text{S}/\text{cm} \times 0,1.$$

The EC value may be used to estimate the TDS concentration in mg/l by multiplying the EC by a factor established for the type of water. For surface water the factor is about 6.5 but will vary with different water sources.

Colour of water can be either true colour caused by dissolved substances or apparent colour caused by colloidal substances. Colour is expressed in mg/l platinum or Hazen units (that are numerically equal). The colour in soft coastal water is generally caused by humic and fulvic acids that derive from decaying plant material. Many industrial effluents also contain colour caused by dyes, for example in the textile industry.

Taste and odour of water can be caused by a variety of substances. These include algal products such as geosmin and 2-MIB (2-methyl isoborneol), inorganic salts such as NaCl, and gasses such as H_2S . Taste and odour are expressed as threshold taste number (TTN) and as threshold odour number (TON) respectively. The threshold numbers are determined by diluting the sample with taste-free or odour-free water until the least perceptible taste or odour is detected.

$$\text{TON} = (\text{ml sample} + \text{ml odour free water}) / \text{ml sample}.$$

Microbiological Quality

The microbiological quality of water is determined by the type and numbers of micro-organisms present in the water. A variety of micro-organisms can be present even in very good quality domestic waters. Most of these micro-organisms are harmless but if the water is polluted pathogens may be present. Pathogens are disease-causing micro-organisms such as those causing cholera, gastro-enteritis, hepatitis, etc.

It is difficult to determine the presence of all the different pathogenic organisms and therefore certain indicator organisms are used to give an indication of the possible presence of pathogens. Indicator organisms are specific types of micro-organisms that are present in very large numbers in the intestines of people and warm-blooded animals. The presence of these organisms in water serves as an indication of pollution of the water by human wastes. Such water is therefore unsafe to drink and must be disinfected before use.

An ideal indicator of water pollution and therefore of the possible presence of pathogens in water should always be present when the pathogenic organism of concern is present and be absent in clean, uncontaminated water, it should be present in large numbers in faecal material and it should be easily detected by simple and inexpensive laboratory tests (certain other requirements are further discussed in Chapter A2).

The following are the most commonly used indicator organisms:

Total coliforms are a group of closely related bacteria that are most commonly used as indicator organisms for drinking water. Although all coliform types are found in the gut of animals including humans and therefore suitable indicators for pollution by human waste, most of them occur widely in the environment, including water and wastewater. This means that they are not specific to pollution by human waste, but can also originate from other sources.

Faecal coliforms and *E.coli* are subsets of the total coliform group. Both groups are better indicators of recent faecal pollution than total coliforms, but they do not provide a distinction between human and animal contamination. The total numbers of these groups are also much lower than those of total coliforms.

Other indicator organisms include: **heterotrophic bacteria** and **coliphages**.

OVERVIEW OF WATER TREATMENT PROCESSES

The principal objective of a water treatment plant is to produce water that is fit for domestic use at a reasonable cost. Many treatment processes (sometimes called unit processes and unit operations) are linked together to form a treatment plant in order to produce water of the desired quality. A distinction is made in some literature between unit processes and unit operations, where the term unit processes refers to those processes where a chemical (or biological) change takes place, while unit operations refer to changes in water quality involving physical phenomena. In this Handbook the term treatment process (or unit process) is used throughout and it is also used to denote unit operations. The reason why only the term 'process' is used, is that often both unit processes and unit operations occur in the same treatment process. The combination of treatment processes is called a process train, or a process flow diagram.

The main factors that must be taken into account when developing a treatment process train include:

- The source water quality (normally referred to as the raw water quality)
- The seasonal (and other) variations in the raw water quality
- The required treated water quality
- Regulatory requirements
- Other factors such as plant size (capacity), site conditions, availability of skilled labour, degree of automation required, economics and many other factors.

The objective is to remove undesirable constituents from the raw water to produce treated water of the required quality and to process the residuals from the treatment processes in a form that can be safely and easily disposed of or reused.

Process selection for the treatment of water is normally based on an overall assessment of the quality of the raw water. In practice this means that water quality and treatment are evaluated in terms of general quality parameters such as turbidity on the one hand, and specific quality parameters on the other hand such as the presence of high levels of iron in the raw water. The turbidity of the raw water determines which clarification processes (coagulation-flocculation, sedimentation, filtration) could be used, while the presence of specific substances of concern determines the inclusion of specific processes in the treatment train.

It must be noted that the quality aspects to be considered in the selection of treatment processes are similar irrespective of the size or scale of the processes. This means that the same quality aspects are relevant both in the case of large-scale treatment plants and package or home treatment processes.

Raw water intake, pumping and flow measurement

Water treatment plants normally have a raw water intake, pumping and conveyance system and flow measurement. Although these systems do not provide any treatment, they are necessary as a part of the overall treatment process train.

Raw water **intakes** are built to withdraw water from a river, lake or reservoir over a predetermined range of water levels. The intake structure can be very simple, e.g. a submerged intake pipe, or an elaborate tower-like structure that can house intake gates, screens, control valves, pumps and chemical feeders. The intakes may be submerged, floating or fixed tower. Submerged and floating intakes are used for small water supply projects. Large projects utilise tower-like intakes that can be an integral part of the dam or can be a separate structure.

Raw water **pumping stations** are generally located at the intake structure. The purpose is to lift the water from the source to an adequate height from where the water can flow by gravity to the plant. Centrifugal pumps are most commonly used for raw water pumping.

The raw water **conveyance or transport system** is designed for the flow of bulk quantities of water from the intake to the treatment plant. The connecting conduit may be a canal, a flume, a pressure pipeline, or a combination of these.

Flow measurement of raw water and finished water is essential for plant operation, process control, water loss control, billing and record keeping. The flow measurement device may be located in the raw-water line, in distribution mains after high-service pumps, or at any other location within a plant. Often more than one flow measurement device may be necessary at various treatment units. Flow of water through pipes under pressure is measured by mechanical or differential head losses, such as Venturi meters, flow nozzles or orifice meters. Flow through an open channel is measured by a weir or a Venturi-type flume such as the Parshall flume.

Unit Processes

All water sources contain different inorganic and organic substances that must be removed during water treatment to produce water that is fit for domestic use. An integral part of the treatment train is the treatment and disposal of the substances that are removed from the water in the most cost effective and safest manner. To achieve this goal, a variety of treatment processes are utilised which employ various physical and chemical phenomena to remove or reduce the undesirable constituents from the water.

Selection of appropriate and effective treatment processes and proper design of the individual processes and process combinations are essential for the successful performance of a water treatment plant. Selection and design decisions made during the design stage can have a major impact on process and plant performance and the total project cost. Errors in process selection and design may have a large impact on the quality of the final water that can be produced, and may require extensive changes during operation to satisfy treated water quality standards.

A summary of different unit processes that are generally used to treat water from different sources is given in Table A1.2.

Combination of unit processes in a treatment process train

Appropriate unit processes from Table A1.2 can be combined into a process train for the desired level of treatment to meet the required water quality. The level of treatment may range from conventional treatment to remove turbidity, taste and odour and to disinfect the water to complete demineralisation of the water. The following considerations generally influence the selection of a treatment process train:

- Ability of the process combinations to meet final water quality objectives, considering both seasonal and long-term changes in raw water quality.
- Topography and site conditions, existing treatment facilities, land area available and hydraulic requirements.

Table A1.2: Unit processes for water treatment

Unit process	Description and application
Trash rack	Provided at the intake gate for removal of floating debris
Coarse screen	Mechanically cleaned screens provided at the intake gate or in the sump well ahead of pumps. Remove small solids
Microstrainer	Removes algae and plankton from the raw water
Aeration	Strips and oxidises taste- and odour-causing volatile organics and gases and oxidises iron and manganese. Aeration systems include gravity aerator, spray aerator, diffuser and mechanical aerator
Mixing	Provides uniform and rapid distribution of chemical and gases into the water
Pre-oxidation	Application of oxidising agents such as chlorine, potassium permanganate and ozone in raw water and in other treatment units to limit microbiological growth and to oxidise taste, odour and colour causing compounds as well as iron and manganese compounds.
Coagulation	Coagulation is the addition and rapid mixing of coagulant with the water to destabilise colloidal particles and form small flocs

Flocculation	Flocculation causes aggregation of destabilised colloidal particles to form rapid-settling flocs
Sedimentation	Gravity separation of suspended solids or floc produced in treatment processes. It is used after coagulation and flocculation and chemical precipitation
Sand filtration	Removal of flocculated and particulate matter by filtration through granular media (normally filter sand). Multi media may also be used (sand and anthracite, or sand and activated carbon, or a third layer may also be incorporated)
Slow sand filtration	Removal of colloidal matter, micro-organisms and colour by means of slow rate filtration through a sand bed on which a layer of colloidal matter and micro-organisms is allowed to form.
Chemical precipitation	Addition of chemicals in water precipitates dissolved solids with low solubility into insoluble form. Removal of hardness, iron and manganese and heavy metals is achieved by chemical precipitation
Recarbonation	Addition of carbon dioxide to reduce pH of water after addition of lime for coagulation or softening
Activated carbon adsorption	Removes dissolved organic substances such as taste and odour causing compounds and chlorinated compounds. It also removes many metals. It is used as powdered activated carbon (PAC) at the intake or as a granular activated carbon (GAC) bed after filtration
Disinfection	Destroys disease-causing organisms in water. Disinfection is achieved mainly by chlorine, but ultraviolet radiation and other oxidising chemicals such as ozone and chlorine dioxide are also used
Chloramination	Ammonia converts free chlorine residual to chloramines. In this form, chlorine is less reactive, lasts longer and has a smaller tendency to combine with organic compounds, thus limiting taste and odours and THM formation
Fluoridation	Addition of sodium fluoride, sodium silicofluoride or hydrofluosilicic acid to produce water that has optimum fluoride level for prevention of dental caries
Desalination	Involves removal of dissolved salts from the water supply. Desalination may be achieved by membrane processes, ion exchange and distillation
Reverse osmosis (RO)	High-quality water permeates very dense membrane under pressure while dissolved solids and some organics are prevented from permeating the membrane. RO is also used for nitrate and arsenic removal
Nanofiltration (NF)	Less dense membranes (than RO) are used for removal of divalent ions (softening), micro-organisms and organics from water under pressure
Ultrafiltration (UF)	Removal of colloidal material and some micro-organisms from water by membranes under pressure
Microfiltration (MF)	Removal of all particulate matter and some colloidal matter
Ion exchange (IX)	The cations and anions in water are selectively removed when water is percolated through beds containing cation and anion exchange resins. The beds are regenerated when the exchange capacity of the beds is exhausted. Selective resins are available for hardness, nitrate and ammonia removal.
Electrodialysis (ED/EDR)	An electrical potential is used to remove cations and anions through ion-selective membranes to produce desalinated water and brine.
Distillation	Used mostly for desalination of seawater

OVERVIEW OF CONVENTIONAL WATER TREATMENT PROCESSES

The term conventional water treatment refers to the treatment of water from a surface water source by a series of processes aimed at removing suspended and colloidal material from the water, disinfecting the water, and stabilising the water chemically.

Conventional treatment of water for domestic use involves a number of treatment steps aimed at achieving the following objectives:

- **Removal of suspended and colloidal matter** to an acceptable level by means of coagulation-flocculation, sedimentation and sand filtration
- **Disinfection** to produce water that is safe to drink
- **Chemical stabilisation** of the water to prevent corrosion of pipelines, attack on concrete pipes and structures or the formation of chemical scale in distribution systems and fixtures

The conventional treatment methods for removal of suspended and colloidal material from water include chemical **coagulation** of small colloidal particles, **flocculation** of the small particles to form larger flocs or aggregates, followed by **sedimentation** and **sand filtration**. When the water contains a large amount of suspended material, larger suspended particles such as sand particles can be removed by means of **settling** without coagulation and flocculation.

Other methods that can be used include slow sand filtration, flotation, micro-filtration and ultra-filtration.

The selection of the best combination of processes to treat water from a particular source depends on a number of factors. These factors include:

- the amount of suspended solids;
- the turbidity of the water;
- the nature of the suspended material;
- the chemical properties of the water (alkalinity and pH);
- the volume of water to be treated, and
- the availability of facilities, trained operators and supervisors.

Simple **settling** of water is often used as a pre treatment step to remove larger suspended particles from water without coagulation-flocculation. Settling requires that the water remains stagnant for a period of time to allow the larger particles to settle to the bottom of a tank or holding reservoir. After settling of the particles clear water can be decanted from the container. Settling can be performed as a batch process (filling a tank with the water, allowing sufficient time for settling, and decanting of the clear water) or as a continuous process. In a continuous process the water flows through the reservoir at a slow rate that allows time for settling while clarified water is withdrawn continuously.

Simple settling is mostly used as a pre-treatment step at a water treatment works when the raw water contains relatively coarse suspended material. The suspended material is removed in a large holding dam through which the water flows at a slow rate to allow sufficient time for the particles to settle. The clear water then flows to the coagulation section if further clarification is required. The sediment must be removed from the dam at regular intervals to prevent the dam from silting up.

Coagulation is the process by means of which the colloidal particles in water are destabilised (i.e. the nature of the colloidal particles is changed) so that they form flocs through the process of flocculation that can be readily separated from the water. Destabilisation is achieved through the addition of chemicals (called coagulants) to the water.

Different chemicals can be used as coagulants. The most common coagulants are:

- **Aluminium sulphate**, also known as alum $\text{Al}_2(\text{SO}_4)_3 \cdot 16 \text{H}_2\text{O}$. The alum is dissolved in water and the aluminium ions, Al^{3+} that form, have a high capacity to neutralise the negative charges which are carried by the colloidal particles and which contribute to their stability. The aluminium ions hydrolyse and in the process form aluminium hydroxide, $\text{Al}(\text{OH})_3$ which precipitates as a solid. During flocculation when the water is slowly stirred the aluminium hydroxide flocs enmesh the small colloidal particles. The flocs settle readily and most of them can be removed in a sedimentation tank.

NOTE Since aluminium may be harmful at high concentrations it must be allowed to precipitate completely as the hydroxide. Complete precipitation is a function of the pH of the water and the pH must therefore be closely controlled between 6,0 and 7,4.

- **Ferric chloride**, FeCl_3 is also commonly used as coagulant. When added to water, the iron precipitates as ferric hydroxide, $\text{Fe}(\text{OH})_3$ and the hydroxide flocs enmesh the colloidal particles in the same way as the aluminium hydroxide flocs do. The optimum pH for precipitation of iron is not as critical as with aluminium and pH values of between 5 and 8 give good precipitation.
- **Hydrated lime** is also used as coagulant, but its action is different to that of alum and ferric chloride. When lime is added to water the pH increases. This results in the formation of carbonate ions from the natural alkalinity in the water. The increase in carbonate concentration together with calcium added in the lime results in the precipitation of calcium carbonate, CaCO_3 . The calcium carbonate crystals also enmesh colloidal particles and facilitate their removal.

When lime is used as coagulant the pH has to be lowered in order to stabilise the water chemically. Carbon dioxide is normally used for this purpose.

- **Polymeric coagulants** including Dadmacs and polyamines which form white or brown flocs when added to water.
- **Polyelectrolytes** are mostly used to assist in the flocculation process and are often called flocculation aids. They are polymeric organic compounds consisting of long polymer chains that act to enmesh particles in the water.
- **Other coagulants** are also sometimes used in water treatment. These include:

Aluminium polymers such as poly-aluminium chloride that provide rapid flocculation, efficient removal of organics, and less sludge than alum under certain conditions, but at a higher cost.

Activated silica is sometimes used as a flocculant together with alum or hydrated lime as coagulant.

Bentonite and/or kaolin are sometimes added to water when the water to be flocculated contains too few particles for effective flocculation.

Flocculation follows coagulation (and is often regarded as part of one process: coagulation-flocculation). The objective of flocculation is to cause the individual destabilised colloidal particles to collide with one another and with the precipitate formed by the coagulant in order to form aggregates that could easily be removed by means of sedimentation or flotation. Flocculation involves the stirring of water to which a coagulant has been added at a slow rate, causing the individual particles to “collide”.

Flocculation is considered to be part of coagulation, although some handbooks treat it as a separate process. Flocculation can take place in different types of equipment. A simple mechanical stirrer can be used for flocculation or a specially designed channel with baffles to create the desired flow conditions can also be used to flocculate the particles in water. The basis of the design of a flocculation channel is that the flow velocity of the water has to be reduced from a high initial value to a much lower value to enable large, strong aggregates to form. If the flow velocity is too high the aggregates may break up again, causing settling of the broken flocs to be incomplete.

Flocculation is controlled through the introduction of energy into the water (through paddles or by means of baffles in the flocculation channel) to produce the right conditions (required velocity gradient) for flocs to grow to the optimum size and strength. The velocity gradient (or G-value) is an extremely important factor that determines the probability of particles to collide and form flocs. If G values are too low, the probability of collisions is low and poor floc formation results. If too high, shear forces become large and this may result in break-up of aggregates.

Aggregates and flocs are removed from water by means of separation processes, i.e. sedimentation and sand filtration; or flotation and sand filtration.

Sedimentation is the process in which the aggregates that have been formed during coagulation and flocculation are allowed to settle from the water. The flocs collect as sludge at the bottom of the sedimentation tank from where it must be removed on a regular basis. The flocs settle to the bottom of the tank and the clean water leaves the sedimentation tank through collection troughs located at the top of the tank.

There are a variety of designs for sedimentation tanks available. These include large rectangular tanks in which the water enters one side and leaves at the other end. This type is normally used at large conventional treatment works. Circular tanks with flat or cone shaped bottoms are also used, especially at smaller works. Flocculated water enters the tank at a central distribution section and clarified water leaves the tank at collection troughs at the circumference of the tank. The design and flow conditions in a sedimentation tank must be such that the minimum amount of flocs leaves with the clarified water.

Sedimentation is a suitable process for removal of flocs formed from silt and clay particles that settle readily. However, certain flocs are relatively light and do not settle readily and a process such as flotation must be used for their removal. Light flocs are formed when algae or organic matter is flocculated.

The flocs that settle in the sedimentation tank collect at the bottom of the tank as sludge from where it must be removed on a regular basis to prevent accumulation in the tank. If sludge is not withdrawn regularly according to operating schedules, the quality of the clarified water may deteriorate due to re-entrainment of sludge.

Flotation is an effective process for removal of relatively light types of flocs. Flotation involves the formation of small air bubbles in water that has to be flocculated. The bubbles attach to the flocs causing them to rise to the surface where they are collected as a froth that is removed from the top of the flotation unit.

Air is dissolved under pressure in a small amount of water in a device called a saturator. This water that is saturated with dissolved air is added to the main stream of water that is to be treated. When the pressure is released after the saturated water is mixed with the water to be treated, the dissolved air comes out of solution in the form of very fine bubbles.

Both sedimentation and flotation remove the bulk of the flocs from the water. However, most of the time a small amount of (broken) flocs or non-flocculated colloidal material remains in the water. This material has to be removed to ensure a low enough turbidity in the water. A sufficiently low turbidity level is required for effective disinfection of the water and to remove all traces of murkiness from the water. Removal of turbidity to low levels is achieved by means of sand filtration.

Sand filtration normally follows sedimentation or flotation as the final 'polishing' step in conventional water treatment. Conventional sand filtration is also termed rapid sand filtration to distinguish it from slow sand filtration as discussed below.

Sand filtration is a simple process in which the water is allowed to filter through a layer of sand in a specially constructed container. In the filtration process the small remaining floc particles are removed by the sand grains and are retained in the bed of sand, while clean water flows out from the bottom of the sand bed.

There are two types of sand filtration processes:

- rapid gravity sand filtration, and
- slow sand filtration.

Rapid sand filtration is used in conventional water treatment following sedimentation or flotation. The filters are open to the atmosphere and flow through the filter is achieved by gravity. Flow is normally downward at rates of about 5 m/h and the filters are cleaned by backwashing at intervals that vary from 12 to 72 hours. Some sand filters are not open to the atmosphere, but operate under pressure. These types of filters are often used in package treatment plants.

During filtration, solids are removed from the water and accumulate within the voids and on the top surface of the filter medium. The filter medium normally consists of a layer of graded sand with a size of about 0,7 mm. and a depth of about 0,8m. Dual media filters are a variation of single-layer sand filters. In these filters a layer of anthracite is placed on top of the layer of sand. This has the advantage of longer filter runs.

The fact that flocs are retained in the filter bed means that the filter will become saturated or clogged with the retained flocs at some stage. The sand has then to be cleaned by means of back washing to remove the accumulated flocs in order to restore the filtering capacity of the sand. The frequency of back washing is determined by the amount of flocs that has to be removed. Backwashing can be controlled on a time basis or on the basis of the pressure drop across the filter.

Slow sand filtration (SSF) on the other hand, has a very slow rate of filtration (compared to rapid sand filtration) and is a process that can be employed as stand-alone treatment process. The filter media in SSF is not back-washed at all, but the filter is cleaned by removal of the top layer of sand at long intervals of weeks.

Disinfection. A large fraction of bacteria and larger micro-organisms are removed during clarification processes, especially by sand filtration. However, many bacteria and viruses still remain in clarified water even at low turbidity levels. It is therefore, essential to disinfect water to prevent the possibility that water-borne diseases are spread by pathogens (disease-causing micro-organisms) in water.

Disinfection of water entails the addition of the required amount of a chemical agent (disinfectant) to the water and allowing contact between the water and disinfectant for a pre-determined period of time (under specified conditions of pH and temperature). Physical methods of disinfection of water include irradiation with ultra-violet light and boiling.

The most commonly used disinfectant is chlorine gas, Cl_2 that is dissolved in the water at a certain concentration for a certain minimum contact time. Other disinfectants include ozone, chlorine dioxide and other chlorine compounds such as calcium hypochlorite (HTH), sodium hypochlorite (bleach) and monochloramine.

Chlorine is a strong oxidising agent and it reacts and oxidises some of the essential systems of micro-organisms thereby inactivating or destroying them. The different forms in which chlorine is used for disinfection, have different oxidising powers and this must be taken into account to ensure effective disinfection.

Chlorine can be added to water in different forms.

Chlorine gas, Cl_2 is delivered to the plant in gas cylinders and the chlorine is introduced into the water by means of special dosing devices (chlorinators).

Calcium hypochlorite, $\text{Ca}(\text{OCl})_2$ (commonly known as HTH) is available in granular or solid (tablet) form and is therefore a very convenient form in which to apply chlorine, especially for smaller or rural plants. It contains between 65 and 70% of available chlorine, it is relatively stable and can be stored for long periods (months) in a cool dry environment.

Sodium hypochlorite, NaOCl (commonly known as household bleach under different brand names) is available as a solution. Water treatment sodium hypochlorite contains 12 to 13% of hypochlorite, which is equivalent to 10 - 12 % available chlorine. Sodium hypochlorite is relatively unstable and deteriorates fairly rapidly, especially when exposed to sunlight. It also forms HOCl and OCl^- upon dissociation.

Monochloramine (so-called combined available chlorine) is also used for water disinfection. It is formed when HOCl is added to water that contains a small amount of ammonia. The ammonia reacts with HOCl to form monochloramine, NH_2Cl . It is much less effective as a disinfectant than HOCl (the same order of effectiveness as chlorite ion). However, it has the advantage of being much more stable in water than free available chlorine. For this reason it is often used to provide residual protection in larger distribution systems.

The two most important factors that determine the effectiveness of disinfection by means of chlorine are the **chlorine concentration** and the chlorine **contact time**. The pH of the water also plays an important role as well as the turbidity of the water, exposure to sunlight and the water temperature. The chlorine concentration is the most important control factor to ensure effective disinfection. However, since chlorine can exist in different forms in water with different degrees of effectiveness as is described above, the concentration of the actual chlorine species used for disinfection must be taken into account. It is normally accepted that sufficient chlorine must be added to water to give a **free chlorine residual** of not less than 0,5 mg/l after 30 minutes contact time.

One of the problems associated with chlorination is the formation of chlorinated by-products. Some of these (so-called trihalomethanes or THM's) have been shown to have negative health effects and for this reason the concentration of THM's is controlled at very low levels in drinking water. It is important therefore to control chlorination dosages and to pretreat the water before chlorine contact to remove organic material in the water (so-called precursor material) to low levels.

An important factor that affects disinfection, is the **turbidity** of the water to be disinfected. The reason is that when water contains colloidal particles, they may "shield" the micro-organisms from the action of the disinfectant, or alternatively react with the chlorine and in this way prevent effective disinfection. It is therefore important to optimise the clarification processes to produce water for disinfection with as low as possible turbidity levels (<1, but preferably <0,5 NTU).

Disinfection by means of **ultra-violet (UV) irradiation** is becoming more and more popular because no by-products are formed in the process. UV radiation kills or inactivates micro-organisms provided each organisms receives a minimum amount of irradiation. UV irradiation functions on the principle that each unit of

water must be exposed to the irradiation for a minimum amount of time at a minimum dosage intensity (fluence).

It is important that the water to be disinfected by UV is properly pre-treated to ensure a low turbidity, preferably lower than 0,5 NTU. If the water contains high turbidity levels the colloids either absorb some of the radiation or shield the micro-organisms against radiation which reduces the effectiveness of the process.

A further important aspect is that the UV tubes are prone to the formation of layers of scale or other fouling material. This also reduces the effectiveness of radiation. It is therefore important that the tubes are regularly inspected and cleaned to prevent formation of scale or accumulation of other material on them. Prolonged use of UV tubes reduces the effective radiation output. This must be compensated for by increasing the power applied to the tubes or accelerating the tube replacement program.

Stabilisation of water refers to the chemical stability (specifically with respect to CaCO_3) of water. Chemical stability affects the tendency of water to be corrosive or to form chemical scale in pipes and fixtures. Stabilisation of water involves the addition of chemicals to the water to adjust its chemical properties in order to prevent corrosion or scale formation.

Water that is not chemically stable may be:

- corrosive towards metal pipes and fittings causing leaks in distribution systems with substantial cost implications,
- Scale-forming, causing a layer of chemical scale to form in pipes and on heating elements. This also has substantial cost implications because the carrying capacity of pipes is reduced and the heat transfer in kettles and geysers is impaired. From a cost point of view, it is very important to ensure that water for domestic use is chemically stable.

Stabilisation of water involves the addition of chemicals to the water to produce water with a calcium carbonate precipitation potential (CCPP) of about 4 mg/l. This means that the water should be slightly supersaturated with calcium carbonate. The effect of this is that a very thin layer of calcium carbonate will form on surfaces protecting it against corrosion. At the low super-saturation value excessive scale formation is avoided.

Sludge treatment and disposal. Sludge from a sedimentation tank has a large pollution potential because it contains all the suspended material removed from the water together with the chemicals used for coagulation. It must therefore be disposed of in a proper manner to prevent contamination of water sources.

The sludge is withdrawn from the sedimentation tank in a diluted form (2-5% m/v solids) and is sometimes thickened (excess water removed) before disposal. At smaller treatment works sludge is disposed of in sludge lagoons. The lagoons are large holding dams in which the sludge compacts and clear water accumulates on top of the sludge. The clear water may be recycled to the inlet of the plant. Water from the backwashing of sand filters have similar characteristics (although much

more dilute) and must be treated and disposed of in the same manner as sludge from sedimentation tanks.

OVERVIEW OF ADVANCED TREATMENT PROCESSES

The term advanced treatment processes refers to processes other than conventional processes, i.e. coagulation-flocculation, sedimentation, filtration, chlorination and stabilisation. Processes normally considered as advanced processes are membrane processes (reverse osmosis RO, nanofiltration NF, ultrafiltration UF and electrodialysis ED), activated carbon adsorption, ozonation, oxidation processes for iron and manganese removal and processes for removal of specific substances such as fluoride.

Reverse osmosis. The main application of RO is to remove dissolved substances, including ions such as Na^+ and Cl^- from solution. RO is a general desalination process being used to desalinate seawater, brackish water and high-TDS effluents. The membranes are continuous in the sense that they do not have any pores. The smallest size of dissolved ions and organics that can be removed by RO is in the order of 0.1 nm (nanometer), which is equal to 0,0001 micrometer, or 0,0000001 mm. RO therefore removes all particulate matter including all bacteria and viruses, all organic macromolecules and most organic molecules with molecular mass of larger than about 150 Daltons (mol mass units). RO therefore produces product water of extremely good quality.

Nanofiltration is also a desalination process since it separates dissolved salts from solution. However, NF membranes contain very small pores and therefore allow substances to pass that are retained by RO membranes. Monovalent ions such as Na^+ and Cl^- readily permeate the NF membrane, while divalent ions such as Ca^{2+} and SO_4^{2-} are rejected to a larger degree by NF membranes. It is therefore effective to soften water (remove Ca, Mg and other hardness causing ions). The types of membranes and modules are similar to those used in RO.

Ultrafiltration is similar to the above two processes in respect of driving force, but it differs greatly in that the membranes are porous. This means that separation is due to a sieve mechanism and dissolved ions and dissolved organics are therefore not removed. However, particulates and macromolecules are rejected. This means that bacteria and viruses are removed as well as larger organic substances such as the so-called precursors for chlorinated compounds including THM's. This characteristic has resulted in the application of UF in drinking water treatment as an alternative for conventional coagulation-filtration-disinfection processes. Pore sizes in UF membranes range from 10-50 nm with operating pressures in the range 200-800 kPa

Microfiltration is very similar to UF with the main difference being pore size, operating pressure and permeate quality. Pore sizes are larger than 50 nm and operating pressures around 100 kPa. Only particulate matter is removed by MF.

Electrodialysis is a membrane separation process in which the driving force is an electrical potential across the membrane. In contrast to pressure-driven processes where water is separated from the feed solution, in electrodialysis charged ions are separated from the feed water. This means that the product water contains less

dissolved salts but that all non-charged compounds such as organic molecules and all particulates including bacteria and viruses will remain in the product water. This is a disadvantage of ED compared to RO but the process has certain other advantages which makes it competitive with RO in many applications.

Oxidation and removal of iron and manganese

Some inorganic compounds in water must first be oxidised to the chemical form that can readily be removed from water. Examples are iron and manganese that occur in some ground waters and some polluted surface water sources in relatively high concentrations. These substances are soluble and invisible and are not removed by conventional treatment processes. However, during water treatment and in the distribution system, iron and manganese may be oxidised and cause problems in the distribution systems and in the home. The iron and manganese products precipitate and settle in the systems and may cause discolouration of water and staining of clothes. It is therefore necessary to remove iron and manganese by means of specialised processes in the treatment plant.

Dissolved iron and manganese occur in reduced form in some waters (Fe^{2+} and Mn^{2+}). The first step in the removal process therefore involves oxidation of the iron and manganese to forms that can subsequently be precipitated and removed during filtration. Oxidation can be achieved by means of oxidants such as chlorine, ozone, potassium permanganate, oxygen or air. The iron is normally precipitated as ferric hydroxide, $\text{Fe}(\text{OH})_3$, while manganese is precipitated as the oxide MnO_2 .

Dissolved iron occurs as Fe^{2+} and is readily oxidised to Fe^{3+} which can be precipitated as $\text{Fe}(\text{OH})_3$ and be removed during sedimentation and sand filtration. Iron can be oxidised by aeration of the water, but sometimes a stronger oxidant such as chlorine may be necessary when the iron occurs in the complexed form.

Manganese is not readily oxidised by air and stronger oxidants are required. Potassium permanganate is an effective oxidant for the oxidation of Mn^{2+} to Mn^{4+} that precipitates as MnO_2 . The sand in a sand filter that is used for the removal of iron and manganese gets coated with a layer of manganese dioxide and this coated sand (green sand) assists in the removal of iron and manganese.

CHAPTER A2: DRINKING WATER QUALITY

Frik Schutte

INTRODUCTION

The term “water quality” describes the physical, chemical and microbiological characteristics of water. These properties collectively determine the overall water quality and the fitness of the water for a specific use. In the case of water to be treated (raw water) the overall quality as well as the values of specific quality parameters determine which processes must be employed to produce water that is fit for its intended use and what the operating parameters should be.

In this chapter an overview is presented of drinking water quality requirements (water that is fit for domestic use) and this is followed by a consideration of specific water quality parameters that are relevant in process selection and operation.

Water must meet certain basic requirements to make it fit for domestic use. The most important requirement is that it must be safe to drink. In addition, the water must be aesthetically pleasing and it must be chemically stable. As far as drinking water quality is concerned, the focus is on health aspects, specifically safe with respect to its microbiological quality (infectious diseases) and its chemical quality (toxicity).

DRINKING WATER QUALITY CRITERIA AND GUIDELINES

There are many lists of quality criteria, standards and guidelines according to which the quality of drinking water is assessed. The most prominent include the Safe Drinking Water Act in the USA with its National Primary Drinking Water Regulations, the World Health Organization’s Guidelines for Drinking Water Quality and the European Union’s Directive related to the quality of drinking water intended for human consumption. Each of these includes lists of many substances with different maximum contaminant levels. Substances are also continuously added to the lists as required by legislation processes in the USA and in the EU.

In South Africa the South African Bureau of Standards specification SANS 241 is used as the official specification for assessing the quality of drinking water. The Water Quality Guidelines for Domestic Use published by DWAF provide a comprehensive discussion of all quality aspects relevant to water for domestic use with recommended quality ranges for different situations. The Assessment Guide published by DWAF, the WRC and the Department of Health gives a user-friendly presentation of the assessment procedure for drinking water. It is recommended that the reader obtain copies of these publications since it is not the objective of this publication to repeat all the details in these publications.

A summary of SANS 241 is given in the tables at the end of the chapter.

HEALTH ASPECTS ASSOCIATED WITH DRINKING WATER

The two main areas of concern associated with the health effects of drinking water are the spread of infectious diseases by micro-organisms, and toxic effects of chemicals in drinking water. Each area of concern involves a wide range of aspects. The details fall outside the scope of this Handbook, and therefore only a general overview is presented of the most important aspects.

MICROBIOLOGICAL QUALITY

Micro-organisms including bacteria, viruses, protozoa and algae are present in all water sources. Most micro-organisms in water are harmless, but disease-causing organisms (called pathogens) may enter water sources as a result of pollution by human and animal wastes and by untreated or poorly treated waste waters discharged into the water source. These organisms cause diseases such as cholera and dysentery if they are present in water that is consumed without treatment. The water therefore has to be disinfected (i.e. the micro-organisms have to be removed or destroyed) to make the water fit for domestic use.

Table A2.1 gives a list of some disease-causing organisms, the disease that each group causes and the typical source (there are also other routes of contamination possible). According to convention all biological species (except viruses) has a Latin name consisting of two words. The first word is the genus (e.g. *Escherichia*) and the second word is the species (e.g. *coli*). The first letter of the genus is capitalised and both genus and species are either printed in italics or are underlined. After the full genus and species names are given in text, further references to the organism may be abbreviated, e.g. *E. coli*.

Table A2.1: Disease-causing organisms

Name of organism	Major disease	Sources
Bacteria		
<i>Salmonella typhi</i>	Typhoid fever	Human faeces
<i>Salmonella paratyphi</i>	Paratyphoid fever	Human faeces
<i>Shigella</i>	Bacillary dysentery	Human faeces
<i>Vibrio cholera</i>	Cholera	Human faeces
Enteropathogenic <i>E. coli</i>	Gastroenteritis	Human faeces
<i>Yersinia enterocolitica</i>	Gastroenteritis	Human and animal faeces
<i>Legionella pneumophila</i>	Legionellosis	Warm water systems
<i>Mycobacterium tuberculosis</i>	Tuberculosis	Human respiratory exudates
Enteric viruses		
Polioviruses	Poliomyelitis	Human faeces
Coxsackieviruses A & B	Aseptic meningitis	Human faeces
Echoviruses	Aseptic meningitis	Human faeces
Reoviruses	Upper respiratory and gastrointestinal illness	Human faeces
Rotaviruses	Gastroenteritis	Human faeces
Adenoviruses	Upper respiratory and gastrointestinal illness	Human faeces
Hepatitis A virus	Infectious hepatitis	Human faeces
Norwalk & related viruses	Gastroenteritis	Human faeces

Table A2.1 (cont.): Disease-causing organisms

Name of organism	Major disease	Sources
Protozoa		
<i>Giardia lamblia</i>	Giardiasis (dysentery)	Human and animal faeces
<i>Cryptosporidium</i>	Cryptosporidiosis	Human and animal faeces
<i>Entamoeba histolytica</i>	Amoebic dysentery	Human faeces
Algae (blue-green) also classified as Arcaobacter		
<i>Anabaena flos-aqua</i>	Gastroenteritis, skin rash	Nutrient enriched water
<i>Microcystis aeruginosa</i>	Gastroenteritis	Nutrient enriched water

Water-borne diseases are usually acute which means that the onset is rapid and that the disease normally lasts only a short period in healthy people. Most often the disease is characterised by gastrointestinal symptoms including diarrhoea, and fatigue. The most serious effect is normally loss of fluid and treatment must therefore focus on preventing dehydration. The time between exposure to a pathogen and the onset of the disease may range from around two days (for most viruses and bacteria) to more than a week for *Giardia* and *Cryptosporidium*. The severity and duration of water-borne diseases is greater in people with weakened immune systems including infants and the elderly.

Indicator organisms

In order to ensure that water is microbiologically safe to drink, there must be no pathogens in the water. However, it would be impossible and time consuming and costly to try and determine the presence of all possible pathogens. For this reason certain groups of organisms are used as indicator organisms. These organisms, such as certain coliform groups occur in the intestines of humans and are easy to detect. Their presence in water is therefore taken as an indication that the water source has been contaminated, or in the case of drinking water that the water was not disinfected properly.

An ideal indicator of water pollution and therefore of the possible presence of pathogens in water should meet the following criteria:

- It should always be present when the pathogenic organism of concern is present and be absent in clean, uncontaminated water
- It should be present in large numbers in faecal material
- It should respond to environmental conditions and treatment in a similar manner as the pathogen
- It should be easily detected by simple and inexpensive laboratory tests
- It should be stable and non-pathogenic

The following groups of organisms are commonly used as indicator organisms:

Total Coliforms

Total coliforms are a group of closely related bacteria that are most commonly used as indicator organisms for drinking water. Although all coliform types are found in the gut of animals including humans and therefore suitable indicators for pollution by human waste, most of them occur widely in the environment, including water and wastewater. This means that they are not specific to pollution by human waste, but can also originate from other sources.

Total coliforms are used to assess the effectiveness of treatment processes and the integrity of distribution systems. Treatment that provides coliform-free water should also reduce pathogen levels to insignificant levels.

An important limitation to the use of total coliforms is that they are not fully suitable to indicate the presence of some pathogenic protozoan cysts/oocysts and some viruses, because they are less resistant to disinfection than these organisms.

Faecal Coliforms and *E.coli*

Faecal coliforms and *E.coli* are subsets of the total coliform group. Both groups are better indicators of recent faecal pollution than total coliforms, but they do not provide a distinction between human and animal contamination. The total numbers of these groups are also much lower than those of total coliforms.

Heterotrophic Bacteria

These bacteria use organic carbon as substrate for energy and growth. Heterotrophic bacteria are not a specific indicator of animal pollution, but they provide an indication of the general microbiological quality of water. A sudden increase in heterotrophic plate counts may indicate a deterioration in microbiological water quality or problems with the treatment process.

Coliphages

Coliphages are viruses that infect coliforms and are present in large numbers in wastewater. They are much easier to detect than human or animal viruses and therefore qualify as indicator organism for faecal pollution of water. Although potentially useful, coliphages have not found acceptance as a generally used indicator organism.

Other Indicators

Other organisms that have been mentioned as indicator organisms include *Clostridium perfringens* and *Bacteriodes*. Each has certain characteristics that make them useful as indicator organisms, but they have not obtained general acceptance for this purpose.

Turbidity and particle counts are non-specific measures of the density of colloidal particles in water. As such, they provide information on the effectiveness of processes that remove colloidal particles, including micro-organisms.

CHEMICAL HEALTH RELATED QUALITY

Every chemical has an effect on any organism ingesting the chemical. Some of these effects are adverse and these can be observed and measured, thus providing a means to assess the effects of chemicals on living organisms. The study of the adverse or toxic effects of chemicals on living organisms is called Toxicology, while the study of the occurrence and manifestation of diseases in populations is called Epidemiology. These two fields of study provide information that is required for decisions on maximum exposure levels to specific toxic chemicals in drinking water, food and the environment. This information is evaluated in terms of risk factors and eventually translated into maximum concentration levels in drinking water. Both organic and inorganic chemicals can produce adverse effects and therefore have to be regulated.

A variety of adverse health effects can occur due to ingestion of chemicals. These effects and symptoms may occur immediately when a large amount of a highly toxic substance is ingested, or the symptoms may only appear after many years of ingesting small amounts. Some effects are dramatic while others are very subtle and may appear only after prolonged periods of exposure. Different terms are used to describe different types of effects:

- Toxic: Causing a deleterious response, seriously disrupting biological functioning, or resulting in death
- Carcinogenic: Causing uncontrolled growth of cells into malignant tumors (cancer)
- Genotoxic: Causing damage to the genetic material in living cells
- Mutagenic: Causing heritable alteration of the genetic material in cells
- Teratogenic: Causing non-hereditary congenital malformations (birth defects)

The results from large numbers of studies from over the world are continuously being evaluated by health experts in order to identify chemicals that are suspected of causing these adverse effects and to determine maximum exposure levels and eventually maximum levels in drinking water. There are many thousands of synthetic chemicals that may find their way into the environment and specifically the water environment through discharge of industrial wastes. Many new chemicals are developed continuously and added to the lists of potential harmful substances. This means that studies about specific adverse chemicals and maximum levels will continue for many years.

Inorganic Chemicals of Concern

Inorganic substances are present in all waters as a result of leaching from the soil or pipes in which the water is transported, or from gasses that dissolve in the water or from contamination by waste discharges. Inorganic substances affect the quality of water in a variety of ways: if the concentration of certain inorganic compounds is too high (or too low), the water may have an unacceptable taste or may be toxic, or the water may be scale forming or corrosive, or the reactions of treatment chemicals may not take place optimally. Some inorganic compounds are known or suspected carcinogens, e.g. arsenic, cadmium and lead. Some inorganic compounds are essential micronutrients, but display adverse health effects at higher levels, e.g. selenium, chromium, manganese and fluoride.

Specific processes must be included in the treatment process train to remove inorganic substances that may cause adverse effects. Processes that may be used include precipitation with lime at elevated pH, oxidation followed by precipitation, ion exchange, adsorption and membrane processes.

Hardness in water is caused by polyvalent cations, mainly calcium and magnesium. Hardness is associated with positive health effects since it contributes to dietary requirements for calcium and magnesium and some studies have indicated positive correlations between consumption of hard water and lower occurrence of cardiovascular disease. Negative aspects of hardness are that it imparts a brackish taste to water and it causes scale formation on surfaces and on geysir elements.

Hardness is generally calculated as the sum of the calcium and magnesium concentrations and is expressed in mg/l CaCO₃. Soft water generally is regarded as water with a hardness of less than 100 mg/l CaCO₃, while hard water has a hardness of higher than 200 mg/l as CaCO₃.

Total dissolved inorganic solids as such do not have any health effects. If the TDS level is higher than about 500 mg/l slight effects may be observed. Even at much higher levels of 1000 mg/l or higher water may have only minor effects such as a laxative effect to consumers not used to drinking the water. At the higher levels the water normally has a salty or brackish taste. TDS is measured collectively as mg/l TDS (or TDIS) or indirectly as electrical conductivity in milli Siemen/m.

Seawater has a TDS of about 33000mg/l, while soft surface water typically has a TDS of less than 50 mg/l. The TDS of typical inland surface water ranges from around 150 to 400 mg/l. Groundwater often has a much higher TDS and hardness than surface water with TDS values of several hundred to a few thousand.

A comprehensive discussion on all the inorganic substances of concern is given in the DWAF document: Water Quality Guidelines for Domestic Use (Volume 1).

Organic Substances of Concern

Organic substances are generally present in most surface waters. Most organic substances are derived from decaying plant matter (humic and fulvic acids) and have no direct health implications. However, some organic substances may affect water quality in a number of ways. They may cause taste and odour in water (e.g. algae by-products), they may have adverse health effects and they may serve as substrate (food) for micro-organisms causing re-growth of organisms after disinfection.

There is growing concern about the potential health effects of organic substances that occur at very low concentrations in some raw water sources from which drinking water is prepared. In the USA and Europe very stringent drinking water quality standards are developed to control the presence of these types of substances in drinking water. Synthetic organic chemicals (SOC's) include many potentially harmful organic substances in water such as pesticides, herbicides, industrial solvents and other industrial wastes that may find their way into water sources.

A specific category of organic substances of concern is the so-called disinfection by-products. These are chlorinated organic compounds that form during disinfection of water when chlorine reacts with naturally occurring organic substances, principally humic and fulvic acids. The products that form are called disinfection by-products, which include the so-called trihalomethanes (THM's) as well as haloacetic acid. The THM's include chloroform (CHCl_3), dichlorobromomethane (CHCl_2Br), chlorodibromomethane (CHClBr_2) and bromoform (CHBr_3).

The presence of THM's, mainly chloroform (CHCl_3), in drinking water is of concern from a health-related aspect, since these compounds have been linked to the occurrence of cancer in test animals. Because THM's, which represent between 5 and 20% of the chlorinated products formed during the chlorination process, have been identified as suspected carcinogens, these compounds are regulated with maximum levels of 100 $\mu\text{g/l}$ in most cases, but levels of 50 and 10 $\mu\text{g/l}$ have also been set.

Chloroform and other trihalomethanes have been shown to increase tumours of the liver, kidney or large intestine in rats or mice. Although several epidemiological studies have been carried out to investigate the possible carcinogenic properties of chlorinated drinking water, the International Agency for the Research on Cancer (IARC) considered that the degree of evidence for an association between chlorination and the occurrence of cancer from these studies is inadequate.

Dissolved organic substances are determined collectively in drinking water as Total Organic Carbon (TOC) or Dissolved Organic Carbon (DOC) as mg/l C and sometimes also as Chemical Oxygen Demand (COD). These analyses give a general indication of the amount of organic material in water but do not give any specific information about the type or specific species present. Individual organic compounds or groups of compounds (e.g. THM) must be determined to obtain information on the concentration of the specific substance or group of substances.

Processes for the removal of dissolved organic substances (such as activated carbon adsorption) are not normally included as standard processes in water treatment plants. They require specialised expertise for their design and operation.

SOUTH AFRICAN NATIONAL STANDARD: Drinking water SANS 241: 2005

The following sections summarise certain aspects of the specification for acceptable drinking water quality according to SANS 241 of 2005. It is recommended that the reader obtains the full SANS 241 specification from SABS.

SANS 241 describes two classes of drinking water:

- Class 1 is considered to be acceptable for lifetime consumption and is the recommended compliance limit.
- Class 2 is considered to present drinking water for consumption for a limited period. This class specifies a water quality range that poses an increasing risk to consumers dependant on the concentration of the determinand within the specified range.

Table A2.2: Microbiological safety requirements

1	2	3	4	5
Determinant	Unit	Allowable compliance contribution ^a		
		95% of samples, min.	4% of samples, max.	1% of samples, max.
		Upper limits		
<i>E. coli</i> ^b or	Count/100 mL	Not detected	Not detected	1
Thermotolerant (faecal) coliform bacteria ^c	Count/100 mL	Not detected	1	10
<p>^a The allowable compliance contribution shall be at least 95% to the limits indicated in column 3, with a maximum of 4% and 1%, respectively, to the limits indicated in column 4 and column 5. The objective of disinfection should, nevertheless, be to attain 100% compliance to the limits indicated in column 3.</p> <p>^b Definitive, preferred indicator of faecal pollution.</p> <p>^c Indicator of unacceptable microbial water quality, could be tested instead of <i>E. coli</i> but is not the preferred indicator of faecal pollution. Also provides information on treatment efficiency and aftergrowth in distribution networks.</p>				

Table A2.3: Physical, organoleptic and chemical requirements

1	2	3	4	5
Determinant	Unit	Class I (recommended operational limit)	Class II (max. allowable for limited duration)	Class II water consumption period ^a max.
Physical and organoleptic requirements				
Colour (aesthetic)	mg/l Pt	< 20	20 – 50	No limit ^b
Conductivity at 25°C (aesthetic)	mS/m	< 150	150 – 370	7 years
Dissolved solids (aesthetic)	mg/l	< 1 000	1 000 – 2 400	7 years
Odour (aesthetic)	TON	< 5	5 – 10	No limit ^b
pH value at 25°C (aesthetic/operational)	pH units	5,0 – 9,5	4,0 – 10,0	No limit ^c
Taste (aesthetic)	FTN	< 5	5 – 10	No limit
Turbidity (aesthetic/operational/indirect health)	NTU	< 1	1 – 5	No limit ^d
Chemical requirements - macro-determinant				
Ammonia as N (operational)	mg/l	< 1,0	1,0 – 2,0	No limit ^d
Calcium as Ca (aesthetic/operational)	mg/l	< 150	150 – 300	7 years
Chloride as Cl ⁻ (aesthetic)	mg/l	< 200	200 – 600	7 years
Fluoride as F ⁻ (health)	mg/l	< 1,0	1,0 – 1,5	1 year
Magnesium as Mg (aesthetic/health)	mg/l	< 70	70 – 100	7 years
Nitrate and nitrite as N (health)	mg/l	< 10	10 – 20	7 years
Potassium as K (operational/health)	mg/l	< 50	50 – 100	7 years
Sodium as Na (aesthetic/health)	mg/l	< 200	200 – 400	7 years

Sulfate as SO ₄ ⁻ (health)	mg/l	< 400	400 – 600	7 years
Zinc as Zn (aesthetic/health)	mg/l	< 5,0	5,0 – 10	1 year
Chemical requirements – micro-determinant				
Aluminium as Al (health)	µg/l	< 300	300 – 500	1 year
Antimony as Sb (health)	µg/l	< 10	10 – 50	1 year
Arsenic as As (health)	µg/l	< 10	10 – 50	1 year
Cadmium as Cd (health)	µg/l	< 5	5 – 10	6 months
Total Chromium as Cr (health)	µg/l	< 100	100 – 500	3 months
Cobalt as Co (health)	µg/l	< 500	500 – 1 000	1 year
Copper as Cu (health)	µg/l	< 1 000	1 000 – 2 000	1 year
Cyanide (recoverable) as CN ⁻ (health)	µg/l	< 50	50 – 70	1 week
Iron as Fe (aesthetic/operational)	µg/l	< 200	200 – 2 000	7 years ^b
Lead as Pb (health)	µg/l	< 20	20 – 50	3 months
Manganese as Mn (aesthetic)	µg/l	< 100	100 – 1 000	7 years
Mercury as Hg (health)	µg/l	< 1	1 – 5	3 months
Nickel as Ni (health)	µg/l	< 150	150 – 350	1 year
Selenium as Se (health)	µg/l	< 20	20 – 50	1 year
Vanadium as V (health)	µg/l	< 200	200 – 500	1 year
Chemical requirements – Organic determinant				
Dissolved organic carbon as C (aesthetic/health)	mg/l	< 10	10 – 20	3 months ^c
Total trihalomethanes (health)	µg/l	< 200	200 – 300	10 years ^f
Phenols (aesthetic/health)	µg/l	< 10	10 – 70	No limit ^b
<p>^a The limits for the consumption of class I water are based on the consumption of 2 litre water per day by a person of mass 70 kg over a period of 70 years. Columns 4 and 5 shall be applied together.</p> <p>^b The limits given are based on aesthetic aspects.</p> <p>^c No primary health effect – low pH values can result in structural problems in the distribution system.</p> <p>^d These values can indicate process efficiency and risks associated with pathogens.</p> <p>^e When dissolved organic carbon is deemed of natural origin, the consumption period can be extended.</p> <p>^f This is a suggested value because trihalomethanes have not been proven to have any effect on human health.</p>				

The suggested minimum frequency of sampling (water works final sample) for different sizes of population served is given in Table A2.4.

Table A2.4: Minimum frequency of sampling

1	2
Population served	Frequency ^a min.
More than 100 000	10 every month per 100 000 of population served
25 001 – 100 000	10 every month
10 001 – 25 000	3 every month
2 500 – 10 000	2 every month
Less than 2 5000	1 every month
^a During the rainy season, sampling should be carried out more frequently.	

GUIDELINES FOR THE APPLICATION OF SANS 241.

Drinking water quality management

A preliminary water quality risk assessment should be carried out by the responsible authority when designing the drinking water quality management system. This should include

- A review of the status quo of all water supply information (sources, treatment, distribution, records, management procedures, etc).
- A detailed preliminary water quality investigation including a full water quality analysis of each raw water source and targeting potentially problematic issues and/or areas.

An ongoing water quality risk management programme should be implemented that should include the following:

- At least one full analysis per year
- Where any changes in the environment, process or delivery occur at least monthly drinking water quality monitoring should be done from source, through treatment and distribution to the end user
- Assurance of the fitness for use of drinking water by analysis against the determinands specified in SANS 241 should not be the only measure to ensure acceptable water quality. It is necessary to implement a water safety plan applying quality management principles aimed at protection of the water source, treatment to the required quality specification and protection of the treated water in the distribution system.

Water quality monitoring programme grading system

General

This water quality monitoring programme grading system is applicable to the waterworks' final water. The grading system may also be used in conjunction with distribution network monitoring. It is recognized that, in many instances, the cost of performing a full analysis against Tables A2.2 and A2.3 can be prohibitive. To enable consumers to take an informed decision regarding the water quality that they are receiving, it is necessary that they obtain the information needed for this purpose. To this end it is recommended that the following grading system be implemented with suggested frequencies of testing for the indicated determinants.

Table A2.5: Example of the use of a water quality monitoring grading system.

1	2	3	4	5	6	7
Programme level	More frequent	Daily	Weekly	Monthly	Quarterly	Annually
Level 1	X					
Level 2		X				
Level 3			X			
Level 4				X		
Level 5					X	X

Note 1 Where no water quality determinants are monitored, this should be made known to the consumers so that they are able to take the necessary steps to protect themselves.

Note 2 It is recommended that a consumer complaints register for the aesthetic qualities of the water be maintained.

Level 1

Analysis of the following water quality determinants is considered the minimum requirement for the purpose of indicating ongoing levels of operational efficiency in a water treatment plant and acceptable water quality within the distribution network:

- conductivity, or dissolved solids;
- pH value;
- turbidity;
- E. coli (or faecal coliform bacteria); and
- Appropriate residual treatment chemicals and disinfectants, such as chlorine (frequent measurement required).

Level 2

In order to comply to this level of monitoring, any water quality determinants, which have been identified from the preliminary or annual analyses (or both) of all water quality determinants listed in tables A2.2, A2.3 and A2.7 that may pose a health threat to consumers, should also be included in the routine monitoring programme outlined under level 1.

Level 3

In addition to the requirements of level 2, the inclusion of the following seven water quality determinants in the routine monitoring programme is recommended for the purpose of establishing, at a manageable cost, the continued acceptability of a given source of groundwater or surface water.

- fluoride as F;
- (nitrate and nitrite) as N;
- coliform bacteria;
- heterotrophic plate count;
- iron as Fe;
- manganese as Mn;
- arsenic as As; and
- somatic coliphages.

Level 4

In addition to the water quality determinants included under level 3, the following physical, organoleptic and chemical determinants should be added:

- taste;
- odour;
- sulphates;
- chlorides;
- sodium;
- trihalomethanes (if chlorination is used);
- aluminium;
- the microbiological indicator determinants listed in Table A2.2 as well as appropriate alert indicators from Table A2.7, with the exception of viruses and protozoan parasites;
- cyanide;
- lead; and
- mercury.

Level 5

All the water quality determinants listed in both Tables A2.2 and A2.3, as well as the alert indicators from Table A2.7 should be included in the routine monitoring programme.

Should abnormal results be encountered in any of these analysis, it might be necessary either to increase the sampling frequency, or to perform additional analyses (or both).

Compliance

To provide consumers with the necessary security, they should be provided with appropriate water quality compliance information.

Table 2.6 Compliance frequency targets in respect of microbiological and chemical requirements that have health implications.

1	2	3	4
Quality of water system	Microbiological requirement	Chemical requirement	
	Column 5 of table 1	Class I	Class I
Excellent	≥ 99 %	≥ 95 %	≥ 97 %
Good	≥ 98 %	≥ 90 %	≥ 95 %
Fair	≥ 97 %	≥ 85 %	≥ 90 %
Poor	≥ 97 %	≥ 85 %	≥ 90 %

NOTE If the compliance frequency targets in respect of microbiological and chemical requirements are in conflict with one another, take a conservative approach and classify performance according to the lower category.

Water quality performance should be established on an annual basis indicating compliance (as a percentage) to each requirement listed in table 1 (microbiological safety requirements) and water quality determinants listed and tested for in respect of each class as indicated in table 2 (physical, organoleptic and chemical requirements). It should be noted that only determinants with health implications should be considered for compliance and the other only included for information and operational purposes. It is also recommended that analyses not performed should be documented.

Table A2.7: Operational water quality alert values.

1	2	3
Determinant	Unit	Alert value
Turbidity	NTU	5
Residual chlorine	mg/ l	< 0,5 ^a
Heterotrophic plate count ^b	count/ml	5 000
[Total] coliform bacteria ^c	count/100 ml	10
Somatic coliphages ^d	count/100 ml	1
Cytopathogenic viruses ^e	count/100 ml	1
Protozoan parasites ^e (Giardia/Cryptosporidium)	count/100 ml	1

^a Dependent on network characteristics and chlorine demand. A residual of 0,5 mg/L applies to the waterwork's final water. The appropriate level in distribution system is 0,2 mg/L. Where other disinfectants are used, appropriate alert levels should be selected.

^b Process indicator that provides information on treatment efficiency and aftergrowth in distribution networks.

^c Indicates potential faecal pollution and provides information on treatment efficiency and aftergrowth.

^d Process indicator that provides information on treatment efficiency and could serve as a model for human enteric viruses.

^e Confirms a risk of infection and faecal pollution, and provides information on treatment efficiency. The detection of selected viruses confirms faecal pollution of human origin.

CHAPTER A3: INTRODUCTION TO WATER CHEMISTRY

Frik Schutte

INTRODUCTION

Water Chemistry forms the basis of most water treatment processes (unit processes) while physical forces and phenomena form the basis of unit operations. However, most water treatment processes involve both chemical and physical forces and for the purpose of this Handbook both physical and chemical changes are referred to as processes. Most processes are based on reactions between chemicals added to water and the substances dissolved or suspended in water, or with water itself. A working knowledge of basic chemical concepts and the reactions that take place in water treatment is therefore essential knowledge for water treatment process controllers and operators.

Water Chemistry is a complex area of study and for the purpose of this chapter only the more basic aspects are considered. Some general chemistry aspects are covered in the first part of the chapter and this is followed by a detailed discussion of concentration units. General water treatment chemical reactions and equations are considered next and these concepts are illustrated by examples and calculations. Acid-base reactions, precipitation equilibria, the carbonate system and oxidation-reduction reactions form the rest of the chapter. Basic mass balance and flow of material concepts and examples are also provided.

Basic chemical aspects

All the substances that are dissolved or suspended in water, like all physical objects, are composed of the following elementary particles:

- electrons
- protons
- neutrons

These elementary particles occur in various combinations to form atoms. The **atom** is the smallest unit of matter that have unique chemical characteristics. Protons and neutrons occur in the nucleus of the atom, while electrons orbit the nucleus.

There are 92 different, naturally occurring atoms, each one called an **element**. An element is defined by its **atomic number** (the number of protons in the nucleus). The **atomic mass** of an element is equal to the sum of neutrons and protons in the nucleus. The atomic mass is an important entity because it is used to calculate the **molar or formula mass** of compounds and the molar concentration of solutions.

Elements occur in “families” with similar properties but with different atomic masses. For example, calcium, strontium and barium are all found together as metal carbonates, while chlorine, bromine and iodine are all reactive volatile elements, readily forming halide salts such as NaCl, NaBr, NaI. The Periodic Table consists of all the elements arranged according to their atomic masses and in their “families”.

Ions. All atoms are electrically neutral because the number of electrons with negative charge equals the number of protons with positive charge. However, an atom may gain or lose one or more electrons, in which case it acquires a net electrical charge and form an ion. If the overall charge is positive the ion is called a **cation** (e.g. Na^+ , Ca^{2+} , Al^{3+}); if the overall charge is negative it is called an **anion** (e.g. Cl^- , O^{2-}). Ions may also be formed by a combination of atoms with an overall charge, called polyatomic ions (e.g. NH_4^+ , OH^- , SO_4^{2-}).

When doing an analysis, the concentration of the ions is determined and reported rather than the concentration of the inorganic compounds.

Molecules are formed through a linking of atoms by means of different kinds of bonding. The water molecule H_2O is formed through covalent bonding of 2 hydrogen atoms with 1 oxygen atom.

Salts. Molecules of salts such as table salt, NaCl or CaSO_4 do not exist individually. They join together to form visible solid crystals. The crystals are formed through ionic bonding between the positively charged sodium and negatively charged chloride. However when NaCl crystals are added to water, each sodium ion and each chloride ion is surrounded by a shell of water molecules. These “hydration shells” keep the ions separated or dissociated and allow the salt to dissolve readily in water to form individual ions.

Other substances such as sugar also dissolve readily in water although they contain no ionic bonds. The reason is that these organic substances are made up of polar molecules containing chemical groups with a net electric charge, or polarity. Organic compounds such as sugar do not form ions when they dissolve, but the molecules as such go into solution.

Molar mass

The **gram mole or mole** is derived from the concept of the “chemical amount” of a substance. It is convenient for the purpose of calculating the mass of substances in a reaction to group atoms or molecules in so-called counting units that contain the same number of atoms or molecules. This counting unit is called the **mole**. One mole of a compound e.g. water contains $6,023 \times 10^{23}$ molecules and is a quantity with a mass in gram equal to the **molecular mass** or formula mass of that compound. For example the formula mass of water is 18,02 g/mol, calculated as follows.

Atomic mass of hydrogen: $\text{H} = 1,008 \text{ g/mol}$ (from chemical tables)
Atomic mass of oxygen $\text{O} = 15,9994$, usually rounded to 16g/mol
Formula mass of $\text{H}_2\text{O} = (2 \times 1,008) + (1 \times 16) = 18,02$

It is significant that one mole contains the same number of molecules, atoms or ions whatever the compound or element. This number of molecules is called Avogadro’s number and is approximately equal to $6,023 \times 10^{23}$.

By definition one mole of a substance contains an Avogadro’s number of atoms, molecules, or ions.

Therefore, $6,023 \times 10^{23}$ **atoms of oxygen** is equal to 15,9994 g O (usually taken as 16); and

$6,023 \times 10^{23}$ **molecules of oxygen** is equal to 31,998 g O₂ (usually taken as 32).

Similarly, 6×10^{23} **molecules of water** is equal to 18,02 g H₂O (usually taken as 18).

The **molecular mass** of a substance (MM) is the mass in grams of one mole of particles (atoms, molecules or ions) of that substance (element, compound or ion).

A one **molar solution** consists of one mole of a substance dissolved in water to make a solution of one litre and is indicated as 1 M. A one **molal solution** on the other hand, consists of one mole of a substance dissolved in 1 kg of pure water.

Note: Molal is 1 mole + 1 kg water;

Molar is 1 mole made up to 1 litre of water

Organic compounds have carbon as a main element in their composition. They behave differently when they go into solution. They mostly do not dissolve as ions but go into solution as molecules of the compound.

A variety of organic compounds (organics) can be present in water. These include natural organic compounds such as algae- and bacterial by-products, carbohydrates and proteins, synthetic organic compounds such as pesticides and herbicides, and products formed during water treatment such as chloroform and other chlorinated products. These organic compounds are usually present in natural waters at very low concentrations, but they may be harmful even at low concentrations.

It is not always possible to determine each individual organic compound in water and it would also be very costly because of the large variety of compounds that may be present at very low concentrations. The determination of aggregate parameters such as Dissolved Organic Carbon (DOC) or Chemical Oxygen Demand (COD) gives an indication of the general organic quality of the water.

CONCENTRATION UNITS

It is extremely important that an analysis, or the dosage of treatment chemicals, or the result of a calculation must be reported as the **value together with the relevant units**. There are different units in which concentration or dosages can be reported and if the units are not stated the result can be interpreted using the wrong units.

SI units are to be used where possible. However, non-SI units are often used in the literature and some are also useful for specific purposes. It is therefore important to be aware of the different non-SI units as well.

The amount of dissolved substances in water is most commonly expressed in concentration units, i.e. mass per volume, mostly in milligram per litre (mg/l). There are however, also other concentration units that are used for certain purposes and for certain constituents as shown below.

Concentration units in (physical) mass per volume

- Milligram per litre, mg/l – most commonly used concentration unit for most substances in water.
- Parts per million, ppm - for dilute solutions ppm is practically identical to mg/l, but it is not part of the SI system and should preferably not be used.
- Microgram per litre, µg/l - used for very low concentrations.
 - 1000 µg/l = 1 mg/l.
- Parts per billion, ppb –for dilute solutions ppb is practically identical to µg/l, but is not part of the SI system and should preferably not be used.
- Gram per litre, g/l – used for high concentrations.
 - 1000 mg/l = 1 g/l.
- Percentage, % - used for high concentrations, e.g. chemicals. Percentage is similar to parts per hundred, or pph or g/100g.

Concentration units in molar mass units per volume

For certain purposes it is essential to express concentration in chemical mass units, rather than physical mass units. For example, for calculations involving titration, solubility- and reaction equilibria the units of moles per volume must be used.

Molarity

- Number of moles of solute per litre of solution, mol/l. One mole of a substance is defined as an amount consisting of $6,023 \times 10^{23}$ particles of the substance (atoms, ions molecules or formula units).

The mass of one mole of a substance can conveniently be calculated as the molecular or formula mass expressed in grams. Concentration in mol/l is known as the molar concentration or **molarity** of the solution.

- Millimoles per litre, mmol/l where one millimole is 1/1000 of a mole or the mass of one millimole calculated as the molecular or formula mass expressed in mg.

Example: Calculate the molar mass of hydrated lime, Ca(OH)₂

$$\begin{aligned}\text{Molar mass of Ca(OH)}_2 &= 40 + 2(16+1) \\ &= 74 \text{ g/mol (or mg/mmol)}\end{aligned}$$

A 1 Molar (1M) solution of Ca(OH)₂ will therefore contain 74 g/l of Ca(OH)₂

A solution containing 74 mg/l of Ca(OH)₂ has a concentration of 0,001 M

Concentration units in chemical equivalents per volume

The Normality (concentration expressed in chemical equivalents per litre) is a measure of the reacting power of a solution. One equivalent of one substance always reacts with one equivalent of another substance.

The equivalent mass of a compound is that mass of the compound which contains one mole of available hydrogen or its chemical equivalent. The equivalent mass of a compound can be determined as follows:

$$\text{Equivalent mass} = \text{Molar mass} / z,$$

where z is a factor which depends on the chemical reaction involved. For acids the value of z is equal to the number of moles of H^+ displaceable from one mole of acid, e.g. for HCl , $z = 1$, while for H_2SO_4 , $z = 2$.

For bases, the value of z is equal to the number of moles of H^+ with which the base will react. For NaOH , $z = 1$ and for $\text{Ca}(\text{OH})_2$, $z = 2$.

For oxidation/reduction reactions, the value of z equals the change in oxidation number of the particular compound involved in the reaction.

For other compounds such as salts that are not involved in oxidation/reduction reactions, the value of z equals the valence (bonding ability) of the compound.

Concentration in equivalents of solute per litre of solution, eq/l. This is known as the **normality** of the solution. A 1 Normal solution contains 1 equivalent of solute per litre of solution.

A 0,001 N solution contains 1 milli-equivalent of solute per litre of solution, meq/l, where one milli-equivalent is equal to 1/1000 of an equivalent.

Example

Calculate the equivalent mass of hydrated lime, $\text{Ca}(\text{OH})_2$

Molar mass of $\text{Ca}(\text{OH})_2 = 40 + 2 \times (16 + 1) = 74 \text{ g/mole}$

There are 2 (OH) groups, $z = 2$

Equivalent mass of $\text{Ca}(\text{OH})_2 = 74/2 = 37 \text{ g/mole}$

A one Normal solution (1N) contains 1 equivalent or 37 g of $\text{Ca}(\text{OH})_2/l$ of water.

A solution containing 37 mg of $\text{Ca}(\text{OH})_2/l$ of water has a concentration of 0,001N

Concentration units in mass per volume expressed on a defined basis

- The concentration of a substance may be expressed on the basis of an element or ion in the compound. The concentration of nitrate (NO_3^-), for example, may be expressed either as mg/l NO_3^- or as mg/l N (NO_3^- -N). Similarly, the concentration of phosphate may be expressed as mg/l PO_4^{3-} or mg/l P.

The conversion between the different nitrogen units from mg/l NO_3^- to mg/l as N or from mg/l N to mg/l NO_3^- is done by multiplying the measured concentration by the ratio of the equivalent mass of N/ NO_3^- or NO_3^-/N respectively.

Example

Express 25 mg/l NO₃⁻ as mg/l N is as follows:

$$25 \text{ mg/l NO}_3^- \times (\text{Equivalent mass of N} / \text{Equivalent mass of NO}_3^-) \\ = 25 \text{ mg/l NO}_3^- \times 14,01/62,01 = 5,65 \text{ mg/l N,}$$

where 14,01 is the equivalent mass of nitrogen and 62,01 is the equivalent mass of NO₃⁻.

To convert 5 mg/l N to mg/l NO₃⁻

$$5 \text{ mg/l N} \times 62,01/14,01 = 22,13 \text{ mg/l NO}_3^-$$

- The concentration in milligram per litre of one compound can also be expressed in terms of mg/l of another compound. In the case of hardness, alkalinity and the concentration of chemicals used for softening of water, concentrations are conventionally expressed in terms of mg/l calcium carbonate (mg CaCO₃/l). This means that the concentration given is not that of the element, ion or compound itself but it is converted to equivalent amounts of CaCO₃ units.

Example

Convert 75mg/l calcium as Ca²⁺ to mg/l as CaCO₃. This is done by multiplying 75 mg/l Ca²⁺ by the ratio of the equivalent mass of CaCO₃ to the equivalent mass of Ca²⁺:

$$75 \text{ mg/l Ca}^{2+} \times (50/20) = 187,5 \text{ mg/l CaCO}_3,$$

Where 50 is the equivalent mass of CaCO₃ (100/2), and 20 is the equivalent mass of Ca²⁺ (40/2).

Table A3.1 gives a summary of the conversions between different sets of units for chemicals normally involved in water treatment.

Table A3.1

Chemical. Concentration in X mg/l	Molar scale. mmol/l	Equivalent scale. Meq/l	Parameter	Concentration of parameter in mg/l CaCO ₃
Ca(OH) ₂ Lime	X/74	X/37	Ca ²⁺ or OH ⁻	X * 50/37
CO ₂ Carbon dioxide	X/44	X/22	CO ₂	X * 50/22
Na ₂ CO ₃ Soda ash	X/106	X/53	CO ₃ ²⁻	X * 50/53
NaOH Caustic soda	X/40	X/40	OH ⁻	X * 50/40
H ₂ SO ₄ Sulphuric acid	X/98	X/49	H ⁺	X * 50/49
HCl Hydrochloric acid	X/36	X/36	H ⁺	X * 50/36

CaCO ₃ Calcium carbonate	X/100	X/50	Ca ²⁺ or CO ₃ ²⁻	X * 50/50
Cl ⁻ Chloride	X/35	X/35	Cl ⁻	X * 50/35
SO ₄ ²⁻ Sulphate	X/96	X/48	SO ₄ ²⁻	X * 50/48

Cation / Anion Balance

A cation-anion balance is an easy way to check the completeness or accuracy of a water analysis. Since water cannot have a net electrical charge, the total amount of cations must equal the total amount of anions, when expressed on a specific basis. The balance can only be done in terms of equivalents or milli-equivalents per litre, or when concentration is expressed as mg/l CaCO₃. These two ways of expression of the concentration of a solution takes the reacting capacity into account, which is not the case for mg/l as ion or moles/l.

Example:

A water analysis giving the major inorganic constituents (cations and anions) and their concentrations in mg/l is shown in the first two columns of the Table below.

Columns 1 and 2 give the ion and concentration in mg/l of the ion.

Column 3 shows the molar, or formula mass of each ion in g/mole or mg/mmmole, given in the Periodic Table of Elements and in Chemistry handbooks.

Column 4 shows the molarity (in mmol/l) calculated by dividing mg/l of ion by the molar mass.

For example, for Ca²⁺: $(107 \text{ mg/l}) / (40,078 \text{ mg/mmmole}) = 2,68 \text{ mmol/l}$.

Column 5 shows the equivalent mass calculated by dividing the molar mass by the valence of the ion (z).

For example, for Ca²⁺: $40,078 / 2 = 20,039 \text{ g/eq, or mg/meq}$.

Column 6 shows the normality in meq/l calculated by dividing mg/l of ion by the equivalent mass.

For Ca²⁺: $(107 \text{ mg/l}) / (20,039 \text{ mg/meq}) = 5,35 \text{ meq/l}$.

Column 7 shows the concentration expressed as mg/l CaCO₃ calculated by multiplying mg/l of ion by the ratio of the equivalent mass of CaCO₃ (50,044 mg/meq) to equivalent mass of ion.

For example, Ca²⁺: $107 \times 50,044 / 20,039 = 267 \text{ mg/l as CaCO}_3$.

Cations	mg/l as ion	Molar mass g/mole	Molarity mmoles/l	Equivalent mass g/eq	Normality meq/l	mg/l as CaCO ₃
Ca ²⁺	107	40,078	2,67	20,039	5,34	267
Mg ²⁺	20	24,305	0,82	12,152	1,64	82
Na ⁺	50	22,990	2,17	22,990	2,17	109
K ⁺	15	39,098	0,38	39,098	0,38	19
Total cations					9,53	477
Anions	mg/l as ion	Molar mass g/mole	Molarity mmoles/l	Equivalent mass g/eq	Normality meq/l	mg/l as CaCO ₃
Total Alkalinity as HCO ₃ ⁻	260	61,017	4,26	61,017	4,26	213
SO ₄ ²⁻	117	96,064	1,22	48,032	2,44	122
Cl ⁻	90	35,453	2,54	35,453	2,54	127
NO ₃ ⁻	20	62,005	0,32	62,005	0,32	16
Total anions					9,56	478
% Difference= 100 (Total anions-total_cations)/ Total cations			0,3%		0,2%	

A check on the accuracy of the analysis is done by comparing the total cation concentration in meq/l to the total anion concentration in meq/l (or the concentrations expressed as mg/l CaCO₃). In this example the totals differ by less than 2 % and the analysis is therefore accepted as accurate.

The composition of the water can be represented visually by a bar diagram. The diagram is constructed with cations in the top part starting with calcium, then magnesium and then other cations. The anions are shown in the bottom part starting with alkalinity. The length of each block representing a particular ion is drawn to scale in meq/l or in mg/l as CaCO₃.

Ca	267	Mg	82	Na	109	19
Alk	213	SO ₄	122	Cl	127	16

This shows that:

$$\begin{aligned}
 \text{Total hardness} &= 267 + 82 = 349 \text{ mg/l CaCO}_3 \\
 \text{Calcium carbonate hardness} &= 213 \text{ mg/l CaCO}_3 \text{ (Ca associated with alkalinity)} \\
 \text{Calcium non-carbonate hardness} &= 267 - 213 = 54 \text{ mg/l CaCO}_3 \text{ (Ca assoc with other ions)} \\
 \text{Magnesium carbonate hardness} &= 0 \text{ (Mg assoc with alkalinity)} \\
 \text{Magnesium non-carbonate hardness} &= 82 \text{ mg/l CaCO}_3 \text{ (Mg assoc with other anions)}
 \end{aligned}$$

WATER TREATMENT REACTIONS AND EQUATIONS

The chemical concepts discussed above form the basis of chemical reactions in water treatment. The reactions are presented by chemical equations that provide a 'chemical picture' of the reaction. The equations also allow one to do basic calculations of chemical dosages, the quantity of active species, quantity of products, etc.

The purpose of a chemical equation is to express what happens during a chemical reaction. Since matter cannot be created or destroyed but converted from one form to another, the same number of atoms and the same mass of material must be present at the end of a reaction compared to the beginning of the reaction. This means that all chemical reactions must be balanced, i.e. all the materials that are shown on the left side of an equation must also be shown on the right side.

In this part the following aspects are considered: general reactions, acid-base reactions, oxidation reactions, precipitation reactions, and the carbonate system in water.

General chemical reactions

A general chemical reaction is one in which no oxidation-reduction reaction takes place. An example of a general reaction in water treatment is the addition of a coagulant such as ferric chloride to water. The ferric chloride reacts with the water and forms certain products. The reaction can be represented by the following equation:

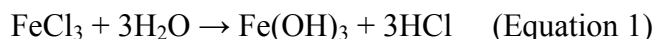

This equation is balanced because the same number of atoms of each element appears on the left and right side of the equation. This equation means that 1 mole of ferric chloride reacts with 3 moles of water to form 1 mole of ferric hydroxide and 3 moles of hydrochloric acid. The ferric hydroxide will normally precipitate as a solid and this can be indicated by adding a vertical arrow next to it, $\text{Fe}(\text{OH})_3\downarrow$.

The HCl is a strong acid and will react with the alkalinity in the water represented as calcium bicarbonate:

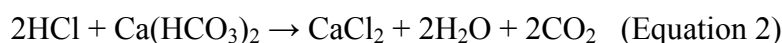

This means that 2 moles of hydrochloric acid react with 1 mole of alkalinity (destroy 1 mole of alkalinity) and produce 2 moles of CO_2 and 1 mole of calcium chloride. These two reactions take place simultaneously and we can therefore add them to give one overall reaction.

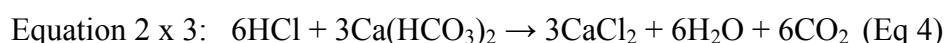
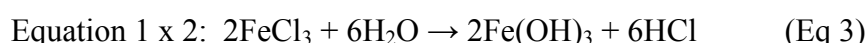

The overall equation shows that 2 moles of ferric chloride react with 3 moles of alkalinity and produce 2 moles of ferric hydroxide and 3 moles of calcium chloride and 6 moles of carbon dioxide.

Similar equations can be written for other coagulants. For aluminium sulphate (Alum, $\text{Al}_2(\text{SO}_4)_3 \cdot 18 \text{H}_2\text{O}$): This indicates that the 18 molecules of water are attached to the $\text{Al}_2(\text{SO}_4)_3$ but do not participate in the chemical reaction. The water molecules must, however, be taken into account when a solution of $\text{Al}_2(\text{SO}_4)_3$ with a specific concentration is prepared.

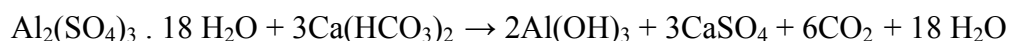

For hydrated lime $\text{Ca}(\text{OH})_2$:

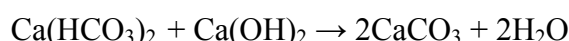

These balanced equations provide information on what happens during the chemical reactions and they can be used to calculate different items such as the mass of calcium carbonate consumed as a result of a certain dosage of ferric chloride, or the mass of ferric hydroxide sludge produced in the reaction. It must be noted however, that the equations given above are actually simplified representations since there are different intermediate species formed during the reactions depending on conditions such as pH.

EQUILIBRIUM CHEMISTRY

Acids such as HCl and H_2SO_4 are termed strong acids and dissociate completely when added to water.



This means that when HCl is added to water, there is virtually no HCl in solution, only H^+ and Cl^- .

However acids such as carbonic acid (H_2CO_3) and acetic acid (CH_3COOH) are weak acids and dissociate only partially when added to water.

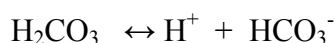

This means that there is an appreciable amount of H_2CO_3 in solution in addition to H^+ and HCO_3^- . The extent of the reaction or the degree to which the reaction proceeds, is given by the dissociation constant:

$$K = \frac{[\text{H}^+][\text{HCO}_3^-]}{[\text{H}_2\text{CO}_3]} = 10^{-6.3} \text{ mole/l}$$

Where the [] indicates concentration in mole/l, and the value of K is constant for the specific substance at a certain temperature. K values for most weak acid-base systems are given in textbooks.

Water is also a weak acid.



$$K = \frac{[\text{H}^+][\text{OH}^-]}{[\text{H}_2\text{O}]} = 1,8 \times 10^{-16}$$

The concentration of water is $(1000/18) = 55,5 \text{ mol/l}$, which gives

$$K_w = [\text{H}^+][\text{OH}^-] = 10^{-14} \text{ mol/l}$$

Where $[\text{H}^+]$ and $[\text{OH}^-]$ are the molar concentrations of H^+ and OH^- . This indicates that the product $[\text{H}^+][\text{OH}^-]$ must always be equal to 10^{-14} mol/l . So, if H^+ is added to water (addition of acid) the concentration of OH^- will drop so that the product of the two concentrations will remain at $K_w = 10^{-14} \text{ mol/l}$

Since the concentration of $[\text{H}^+]$ and $[\text{OH}^-]$ can vary over the very wide range of 10 to 10^{-14} it is convenient to use a logarithmic scale to express the concentration. For this purpose the pH function was introduced as:

$$\text{pH} = -\log [\text{H}^+]$$

This means that a $[\text{H}^+]$ concentration of 10^{-7} mole/l is expressed as a pH of 7. At this pH the concentration of $[\text{OH}^-]$ must therefore also be 10^{-7} mol/l in order to maintain the value of K_w . This value is therefore referred to as the neutral pH because the concentrations of both ions are equal.

Similarly a $[\text{H}^+]$ concentration of 10^{-3} mol/l is expressed as a pH of 3, and the $[\text{OH}^-]$ concentration must then be 10^{-11} mol/l . All pH values below 7 are acidic and those above 7 are alkaline.

Because the pH scale is logarithmic, it means that a change of one pH unit is equal to a 10 times increase in concentration of the one type of ion and a 10 times decrease in concentration of the other type.

The carbonate system

Water contains various dissolved species and ions. These species interact with one another and with water. One of the most important systems in water that has an important effect on water treatment is the carbonate system. The species that make up the carbonate system are the following: CO_2 , H_2CO_3 , HCO_3^- , CO_3^{2-} , H^+ and OH^- .

Carbon dioxide is present in the atmosphere and it dissolves in water to form the weak acid, carbonic acid, which then dissociates into the hydrogen and bicarbonate ions according to reaction.

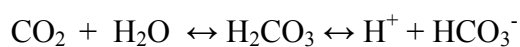

$$K_a = \frac{[\text{H}^+][\text{HCO}_3^-]}{[\text{H}_2\text{CO}_3]} = 10^{-6,3} \text{ mole/l}$$

The bicarbonate ion in turn, dissociates to form H^+ and the carbonate ion CO_3^{2-}

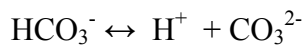

$$K_b = [H^+] [CO_3^{2-}] / [HCO_3^-] = 10^{-10,3} \text{ mole/l}$$

The total carbonic species in solution is represented by C_t and is:

$$C_t = [H_2CO_3] + [HCO_3^-] + [CO_3^{2-}]$$

The relative amount of each species is a function of the pH of the water. The equations above can be used to calculate the relative amounts and plot these values on a so-called pH-pC diagramme. This type of diagramme shows the log of the concentration (pC) of the different species as a function of pH.

Figure A3.1 shows an example of the log C vs pH plot for the carbonate system.

This shows how the concentration of the different species (as log) varies as a function of pH. It shows that at low pH levels the dominant species is H_2CO_3 up to a pH of about 6. At pH 6,3 the concentrations of H_2CO_3 and HCO_3^- are equal and thereafter the HCO_3^- species is dominant up to a pH of about 10. At pH of 10,3 the concentrations of HCO_3^- and CO_3^{2-} are equal and at higher concentrations CO_3^{2-} dominates.

The figure also shows how the concentrations of H^+ and OH^- vary as a function of pH.

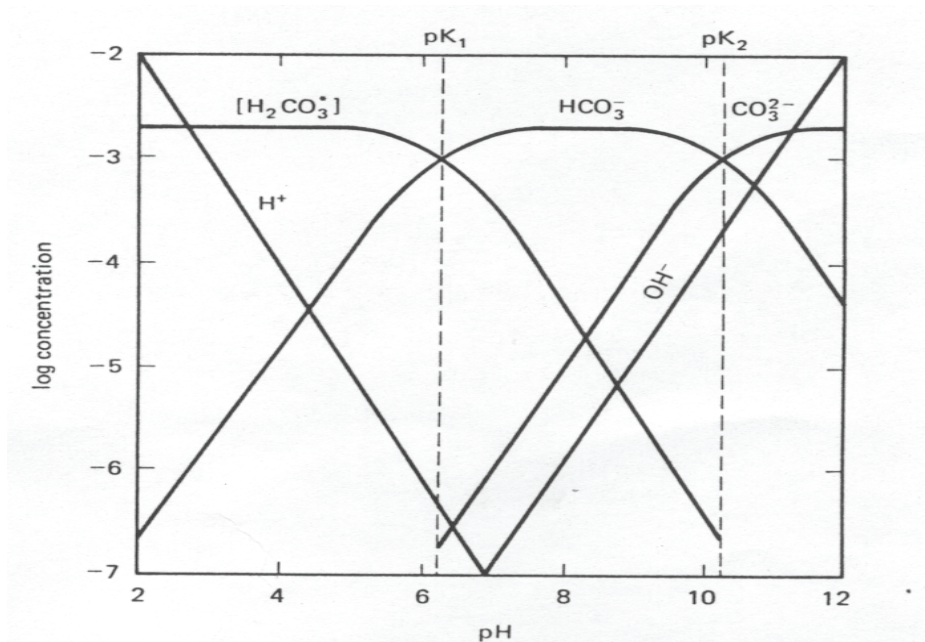

Figure A3.1 Log [concentration] - pH for carbonate system

Alkalinity and acidity

As is indicated above, alkalinity reacts with hydrochloric acid that forms upon addition of ferric chloride to water. Alkalinity can therefore be regarded as the acid neutralising capability of water. Alkalinity is determined by titration of a water sample with a standardised strong acid to a specific pH end point. The end point to which titrations are carried out, are selected to give an indication of the type of alkalinity (or the carbonate species) that is present.

Total Alkalinity is determined by titration to the end point where all the species contributing to alkalinity (OH^- , CO_3^{2-} and HCO_3^-) have been neutralised. This end point is the methyl-orange end point, which is approximately pH 4,5 depending on the initial condition of the water. This alkalinity is termed Total Alkalinity or M-Alkalinity, or H_2CO_3 Alkalinity.

Titration to the phenolphthalein endpoint of pH 8,4 gives the contribution of hydroxides and carbonates to alkalinity. This is termed P- or Phenolphthalein alkalinity or HCO_3^- Alkalinity.

Total Alkalinity can also be calculated from the following relationship:

$$\text{T Alkalinity} = (\text{OH}^-) + (\text{HCO}_3^-) + (\text{CO}_3^{2-}) - (\text{H}^+)$$

The **buffer capacity** is closely related to the amount of alkalinity in the water. Buffer capacity is the ability of the water to absorb acid without a substantial decrease in pH.

Acidity is defined as the base neutralising capacity of water and is determined by titration of the water with a standardised strong base to certain pH end points. Acidity can be calculated from the following expression:

$$\text{Acidity} = (\text{H}_2\text{CO}_3) + (\text{HCO}_3^-) + (\text{H}^+) - (\text{OH}^-)$$

Where these terms are expressed in mg/ℓ as CaCO_3 . This end point is more difficult to determine and acidity is therefore only used for specific purposes.

SOLUBILITY EQUILIBRIA

The solubility of salts in water varies widely. Certain salts have very high solubilities, e.g. NaCl , while others have very low solubilities. This characteristic of low solubility is often used to separate such a compound from water by precipitating it as an insoluble precipitate.

When the concentration of ions of a sparingly soluble salt is increased beyond a certain point in solution the salt will start to precipitate from solution. For example when the Ca^{2+} and CO_3^{2-} concentration is increased beyond the maximum solubility, solid CaCO_3 will precipitate.

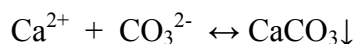

This reaction forms an equilibrium that can be quantified by the following expression:

$$K_s = [\text{Ca}^{2+}] [\text{CO}_3^{2-}]$$

Where K_s is the equilibrium constant or the solubility product for CaCO_3 , and $[\text{Ca}^{2+}]$ and $[\text{CO}_3^{2-}]$ represent the molar concentrations of the cation and anion respectively.

K_s represents the maximum value the product of the ion concentrations can have for a given set of conditions.

If $[\text{Ca}^{2+}] [\text{CO}_3^{2-}] < K_s$ the solution is under-saturated and no precipitate will form.

If $[\text{Ca}^{2+}] [\text{CO}_3^{2-}] > K_s$ the solution is super-saturated and CaCO_3 will precipitate until the ion product just equals K_s .

The smaller the value of K_s the lower the solubility of the compound and the easier it is to remove the compound to a very low concentration. For example the K_s value for $\text{Fe}(\text{OH})_3$ is equal to 10^{-37} mol/l. This very small value means that ferric hydroxide will precipitate almost completely from water. However, the solubility depends greatly on pH and it is therefore important to maintain the pH of water within the correct range to ensure as complete as possible precipitation of a substance.

Example

Calculate the concentration of Ca^{2+} (aq) in a saturated CaSO_4 solution in water in mg/l if the

$$K_{sp} = 1.9 \times 10^{-4}$$

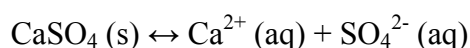

For each mole of CaSO_4 (s) that dissolves, one mole of Ca^{2+} (aq) and one mole of SO_4^{2-} (aq) are formed

$$K_{sp} = [\text{Ca}^{2+}] [\text{SO}_4^{2-}] = 1.9 \times 10^{-4}$$

Say the molar concentration of each ion = y, then

$$y^2 = 1.9 \times 10^{-4}$$

$$y = 0.0138 \text{ mole/l}$$

$$1 \text{ mole of } \text{Ca}^{2+} = 40 \text{ g/mole, so}$$

$$y = 0.0138 \text{ mole/l} \times 40 \text{ g/mole} = 0.552 \text{ g/l or } 552 \text{ mg/l}$$

Common ion effect

The solubility behaviour of a precipitate in a solution that contains a common chemical species is important in process chemistry. It forms the basis of precipitation processes for removal of heavy metals and for softening of hard waters.

In the reaction $\text{Ca}^{2+} + \text{CO}_3^{2-} \leftrightarrow \text{CaCO}_3$ the addition of either Ca^{2+} or CO_3^{2-} ions will result in the value of the ion product being greater than K_s . $[\text{Ca}^{2+}][\text{CO}_3^{2-}] > K_s$ and precipitation will occur until a new equilibrium is established where the ion product is just equal to K_s .

$$K_s = [\text{Ca}^{2+}][\text{CO}_3^{2-}] = 4,7 \times 10^{-9}$$

The concentration of calcium and carbonate at equilibrium can be calculated as follows:

Since 1 mole of calcium reacts with 1 mole of carbonate we can write:

$$[\text{Ca}^{2+}][\text{CO}_3^{2-}] = [\text{Ca}^{2+}]^2 = 4,7 \times 10^{-9}$$

$$[\text{Ca}^{2+}] = 0,0000686 \text{ mol} / \ell$$

$$\text{Ca}^{2+} = 0,0000686 \times 40,08 \times 1\,000 \text{ mg} / \ell$$

$\text{Ca}^{2+} = 2,75 \text{ mg} / \ell$, which is the theoretical maximum value of the ions in solution before precipitation will commence. In practice however, these low values are not easily achieved.

The solubility behaviour of most slightly soluble salts is much more complicated than is suggested by this example. Complex formation, hydrolysis, pH and other phenomena have important effects on solubility behaviour.

Example

Calculate the residual magnesium concentration that exists in a saturated magnesium hydroxide solution if enough sodium hydroxide has been added to the solution to increase the equilibrium pH to 11,0.

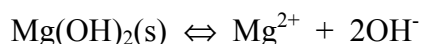

The solubility product constant for this reaction $K_{sp} = 1,2 \times 10^{-11}$.

Determine the hydroxide ion concentration:

$$K_w = [\text{H}^+][\text{OH}^-] = 10^{-14} \text{ at } 25^\circ\text{C}$$

Because the pH is 11, $[\text{H}^+] = 10^{-11} \text{ mole} / \ell$

we know that

$$[\text{OH}^-] = 10^{-14} / 10^{-11} = 10^{-3} \text{ mole} / \ell$$

Establish the solubility product constant expression, and solve for the magnesium ion concentration:

$$K_{sp} = [\text{Mg}^{2+}][\text{OH}^-]^2$$

$$[\text{Mg}^{2+}] = (1,2 \times 10^{-11}) / (10^{-3})^2$$

$$= 1,2 \times 10^{-5} \text{ mol/l or } 0,29 \text{ mg/l}$$

Since hardness ion concentrations are normally expressed as mg/l CaCO₃, multiply the concentration by the ratio of the equivalent weights:

$$0,29 \times 50 / 12,2 = 1,2 \text{ mg/l as CaCO}_3$$

Softening. The concepts of solubility, common ion effect, hardness and the carbonate system can be illustrated by the reactions that take place during chemical softening of water. Softening involves the removal of calcium and magnesium ions from the water. Softening can be achieved by means of ion exchange or nanofiltration or by means of chemical precipitation.

In the chemical precipitation process calcium is precipitated as calcium carbonate, CaCO₃ and magnesium as magnesium hydroxide, Mg(OH)₂, since these compounds have low solubility product values of $4,7 \times 10^{-9}$ for CaCO₃ and $8,9 \times 10^{-12}$ for Mg(OH)₂ respectively.

In order to precipitate CaCO₃ the solubility product must be exceeded. This means that the concentration of calcium and carbonate ions must be increased. This can be achieved by the addition of hydrated lime, Ca(OH)₂ which will increase the Ca²⁺ concentration and at the same time increase CO₃²⁻ concentration (for calcium carbonate hardness). The CO₃²⁻ concentration is increased as a result of the increase in pH to about 10,3 (due to the addition of OH⁻ ions) which causes the bicarbonate ions HCO₃⁻ to be converted to CO₃²⁻ as can be seen in the pH-pC diagram of the carbonate system.

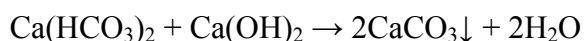

In the case of calcium non-carbonate hardness the ions associated with calcium cannot be converted to carbonate ions and a different strategy must be used. In this case lime is first added to increase the pH and add calcium to precipitate whatever carbonate hardness is present. In order to utilise the common ion effect a source of carbonate ions must be added and sodium carbonate, Na₂CO₃, also called soda ash is used.

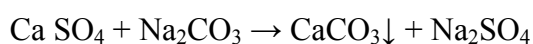

In the case of magnesium hardness the magnesium is precipitated as magnesium hydroxide, Mg(OH)₂. The minimum solubility of magnesium hydroxide is at a pH of about 11, so more lime must be added to increase the pH and at the same time add more OH⁻ ions in order to exceed the solubility product.

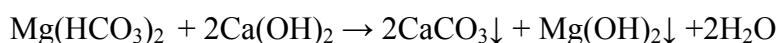

In the case of magnesium non-carbonate hardness lime must be added to increase the pH and supply OH⁻ ions and then soda ash must be added to precipitate the excess calcium ions added.

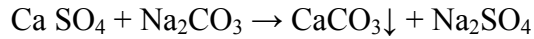
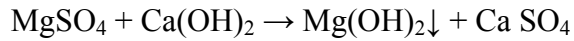

Recarbonation. When water has been treated by the addition of lime and soda ash the pH is normally around 11 and the water has to be stabilised before distribution. This is normally achieved through the addition of CO₂ to reduce the pH to the level where the water is stable with respect to CaCO₃ (normally at a CCPP of 4 mg/l and a pH level of 7 to 8,5).

Recarbonation involves the addition of CO₂ to neutralise excess OH⁻ ions and to convert carbonate ions to the bicarbonate form to reduce the scale-forming potential of the water. This can be done in a two-stage or one-stage process. In a two-stage process CO₂ addition takes place to neutralise Ca(OH)₂ and precipitate excess CaCO₃ which is removed in a settler. Further addition of CO₂ converts CO₃²⁻ to HCO₃⁻ to prevent precipitation of CaCO₃ on filter sand or in distribution systems.

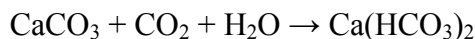
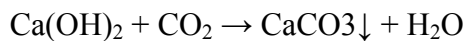

OXIDATION – REDUCTION REACTIONS

In oxidation-reduction or redox reactions some of the atoms or ions undergo a change in oxidation number, which implies that electrons are gained or lost by the atoms. Oxidation is the loss of electrons resulting in an increase in oxidation number of one or more atoms. Reduction is a gain in electrons resulting in a decrease in oxidation number. The two processes must always occur simultaneously. An oxidising agent is an atom, ion or molecule that takes up electrons from other substances.

An example of a redox reaction is the oxidation by chlorine of soluble manganese (ii) and the subsequent removal of manganese by precipitation of manganese (iv) dioxide. Some elements such as iron and manganese may have different oxidation numbers depending on the compound or the reaction in which it is involved. The oxidation number is calculated on the basis that the net charge of a molecule must be zero, and that of an ion must be the charge that the ion carries. For example, the oxidation number of manganese in MnO₂ is +4 because the oxidation number of oxygen is always -2 and since there are 2 O atoms for each Mn atom [2 x (-2) = (-4)]

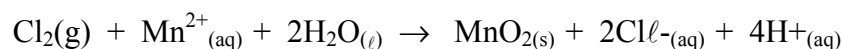

ox number: 0 +2 +1 -2 +4 -2 -1 +1

Electrons are negatively charged entities. This means that when an atom loses one electron, it loses one negative charge, or gains one positive charge. Manganese loses 2 electrons per Mn atom when changing from the +2 state in Mn^{2+} to the +4 state in MnO_2 . Since oxidation is defined as a loss of electrons Mn^{2+} is oxidized to the +4 state. Chlorine on the other hand gains one electron per atom when changing from molecular chlorine to the chloride ion and is therefore reduced in the process. Chlorine is the oxidising agent that oxidises manganese and in the process chlorine is reduced. Since electrons cannot be destroyed, the total gain in electrons must always equal the total loss in electrons. The 2 electrons lost by Mn^{2+} equal the 2 electrons gained by the 2 chlorine atoms, each gaining one electron.

Oxidation-reduction reactions play an important role in water treatment. Examples include the oxidation of ammonia by chlorine in the breakpoint reaction. Another example is the oxidation of iron and manganese by oxygen in the air, or by chlorine, or potassium permanganate. A further example is the oxidation of organic material causing taste and odour in the water by chlorine or ozone.

The oxidising agents (or oxidants) used in water treatment include oxygen, chlorine, ozone, chlorine dioxide, potassium permanganate, hydrogen peroxide.

Chlorine chemistry

Chlorine is a strong oxidising agent and it reacts and oxidises some of the essential systems of micro-organisms thereby inactivating or destroying them. The different forms in which chlorine is used for disinfection, have different oxidising powers and this must be taken into account to ensure effective disinfection.

Chlorine is normally used for disinfection on large plants in the gaseous form, but calcium hypochlorite and sodium hypochlorite are two other chlorine compounds that can also be used for disinfection.

Chlorine gas, Cl_2 dissolves in water to form hypochlorous and hydrochloric acid.

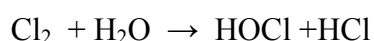

The actual disinfecting agent is hypochlorous acid which dissociates as follows:

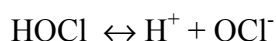

The H^+ formed in the process reacts with alkalinity and leads to a reduction in alkalinity, and may lead to a reduction in pH if insufficient alkalinity is available.

The chlorine species in the form of hypochlorous acid, HOCl plus the hypochlorite ion, OCl^- are termed free available chlorine. Chlorine in the form of monochloramine (together with other chloramine species) is termed combined available chlorine (see below under break point chlorination).

HOCl is much more effective for disinfection than the hypochlorite ion - about 80 (or even more) times more effective. The relative quantities of these two species are determined by the pH of the water. At pH below 7, HOCl is the predominant species while at pH above about 7,5 hypochlorite ion, OCl⁻ predominates. It is therefore important that the pH of the water be taken into account when determining the required chlorine dosage for disinfection.

Calcium hypochlorite (commonly known as HTH) dissolves in water as follows:



the hypochlorite ion hydrolyses to form HOCl:

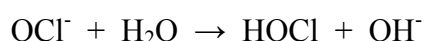

The OH⁻ formed in the process results in an increase in pH (in contrast to chlorine gas where H⁺ is formed).

Sodium hypochlorite, NaOCl (commonly known as household bleach under different brand names) is available as a solution. Water treatment sodium hypochlorite contains 12 to 13% of hypochlorite, which is equivalent to 10 - 12 % available chlorine. Bleach contains about 6 – 8% free available chlorine. Sodium hypochlorite is relatively unstable and deteriorates fairly rapidly, especially when exposed to sunlight.

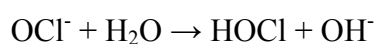
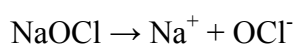

Monochloramine (so-called combined available chlorine) is also used for water disinfection. It is formed when HOCl is added to water that contains a small amount of ammonia. The ammonia reacts with HOCl to form monochloramine, NH₂Cl. It is much less effective as a disinfectant than HOCl (the same order of effectiveness as chlorite ion). However, it has the advantage of being much more stable in water than free available chlorine. For this reason it is often used to provide residual protection in larger distribution systems.

An important concept in disinfection by means of chlorine is that of breakpoint chlorination.

Breakpoint chlorination refers to the reaction between chlorine and ammonia in water. When chlorine is added to water it reacts with ammonia. In this process chloramines are formed. When more and more chlorine is added it breaks down (oxidises) the chloramines and then forms free available chlorine and nitrogen. The point where all chloramines have been oxidised is termed the breakpoint. The important point is that only after the break point has been reached, free available chlorine is formed resulting in effective disinfection. Chlorine also reacts with other compounds that exercise a chlorine demand such as certain organics, iron and manganese. These reactions do not participate in the breakpoint reaction. Figure A3.2 shows a typical breakpoint curve.

The following reactions take place when chlorine is added to water containing ammonia:

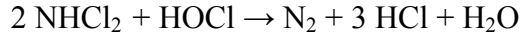
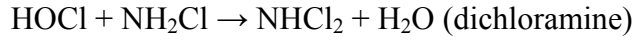
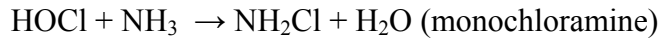
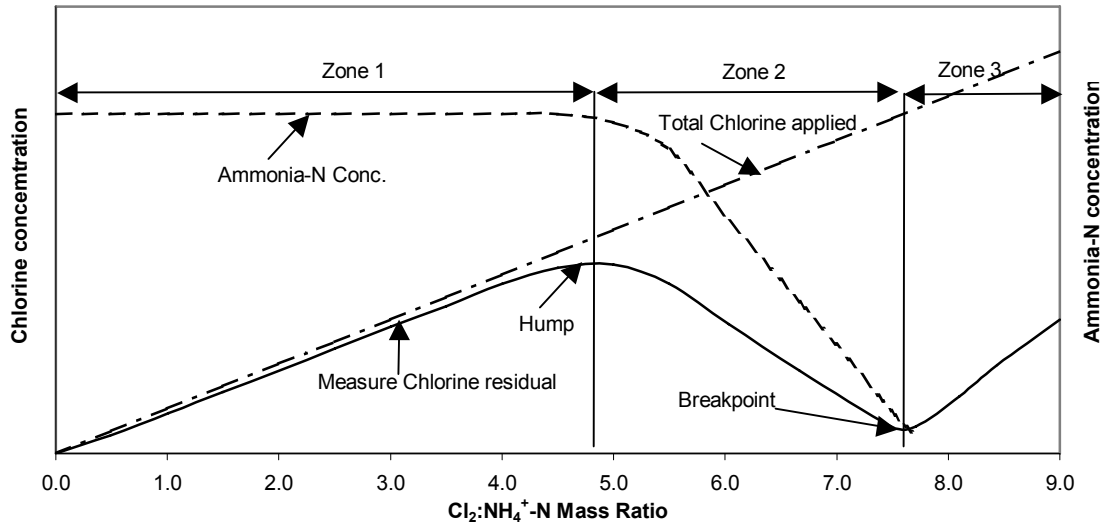

Figure A3.2 Breakpoint curve



CHAPTER A 4: WATER TREATMENT CALCULATIONS

Frik Schutte

INTRODUCTION

There are many types of calculations that treatment plant operators and process controllers must be able to perform. These include:

- Calculation of mass of chemicals to make up chemical solutions of a specified concentration
- Calculation of chemical dosages
- Calculation of species concentration
- Calculation of the mass and volume of wastes produced

Different types of problems and calculations require different approaches and different techniques. For example, to calculate the mass or concentration of certain species in a reaction, the starting point is to compile a balanced equation of the chemical reaction. For the calculation of species concentration in precipitation reactions, equilibrium equations and expressions are the starting point. For calculation of dosages and material flow, the starting point may be to compile a mass balance of the system. The different approaches are discussed in the following sections and are illustrated by examples.

CALCULATIONS FROM CHEMICAL EQUATIONS

Chemical treatment processes can be represented by chemical reactions and these reactions form the basis of many chemical calculations. Reactions are presented by chemical equations that provide a 'chemical picture' of the reaction. The equations allow one to do basic calculations of chemical dosages, the quantity of active species, quantities of products, etc.

The purpose of a chemical equation is to express what happens during a chemical reaction. Since matter cannot be created or destroyed but only be converted from one form to another, the same number of atoms and the same mass of material must be present at the end of a reaction compared to the beginning of the reaction. This means that all chemical reactions must be balanced, i.e. all the materials that are shown on the left side of an equation must also be shown on the right side.

As an example let us review the reaction when ferric chloride is added to water as coagulant:

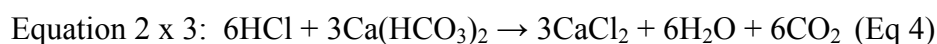
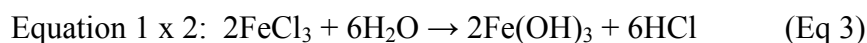
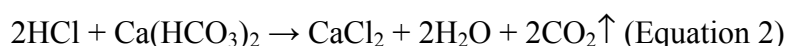
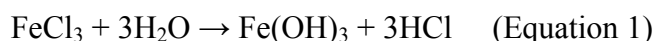

These two equations can be added to give the overall reaction:

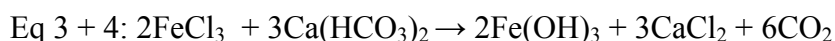

The overall equation shows that 2 moles of ferric chloride react with 3 moles of alkalinity and produce 2 moles of ferric hydroxide and 3 moles of calcium chloride and 6 moles of carbon dioxide.

Similar equations can be written for other coagulants. For aluminium sulphate (Alum, $\text{Al}_2(\text{SO}_4)_3 \cdot 18 \text{H}_2\text{O}$):

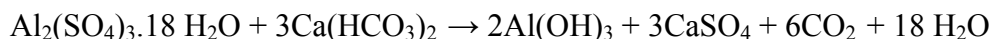

For lime $\text{Ca}(\text{OH})_2$:

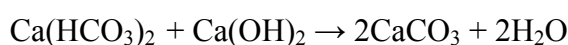

These equations are the starting place for most of the general types of calculations performed on water treatment chemicals and related aspects. The following examples illustrate these types of calculations.

Example 1:

How much alkalinity is consumed by the addition of 15 mg/l FeCl_3 to water?

From the balanced equation above:

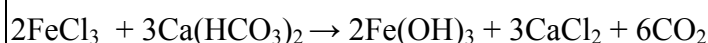

3 moles of $\text{Ca}(\text{HCO}_3)_2$ are consumed by 2 moles of FeCl_3

Mol Mass of $\text{FeCl}_3 = 55,8 + (3 \times 35,5) = 162,3 \text{ mg/mmol}$

Mol Mass of $\text{Ca}(\text{HCO}_3)_2 = 40 + 2[1 + 12 + (3 \times 16)] = 162 \text{ mg/mmol}$

That is: $3 \times 162 = 486 \text{ mg/l } \text{Ca}(\text{HCO}_3)_2$ in solution is consumed by $2 \times 162,3 = 324,6 \text{ mg/l } \text{FeCl}_3$

That is: $486 / 324,6 = 1,5 \text{ mg/l } \text{Ca}(\text{HCO}_3)_2$ is consumed per $\text{mg/l } \text{FeCl}_3$

For 15 mg/l FeCl_3 : $15 \times 1,5 = 22,5 \text{ mg/l}$ alkalinity as $\text{Ca}(\text{HCO}_3)_2$ is consumed.

Alkalinity is normally expressed as CaCO_3 , and the conversion can be done as follows:

$$\begin{aligned}
 22,5 \text{ mg/l as Ca(HCO}_3)_2 &= 22,5 \times \text{Eq mass CaCO}_3 / \text{Eq mass Ca(HCO}_3)_2 \\
 &= 22,5 \times 50/81 \\
 &= 13,9 \text{ mg/l CaCO}_3
 \end{aligned}$$

The implication is that if the water contains less alkalinity than 22,5 mg/l as Ca(HCO₃)₂ or 13,9 mg/l as CaCO₃, the pH will drop as a result of the dosing of 15 mg/l FeCl₃.

Example 2:

Water with a low alkalinity of 12 mg/l as CaCO₃ is to be treated with alum together with lime to add alkalinity. Determine the amount of lime as CaO to be added to prevent the pH from dropping if the alum dosage is 55 mg/l.

Al₂(SO₄)₃ reacts with lime as follows:

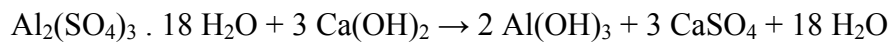

Al₂(SO₄)₃ reacts with natural alkalinity as follows:

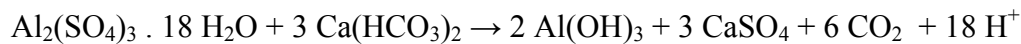

Amount of alum that will react with natural alkalinity:

$$\begin{aligned}
 \text{Alkalinity} &= 12 \text{ mg/l as CaCO}_3 \times 162,1 \text{ mg/l Ca(HCO}_3)_2 / 100 \text{ mg/l CaCO}_3 \\
 &= 19,4 \text{ mg/l Ca(HCO}_3)_2
 \end{aligned}$$

$$\text{MW of alum} = 27 \times 2 + 3[32 + (16 \times 4)] + 18(2 + 16) = 666$$

$$\text{MW of Ca(HCO}_3)_2 = 162,1$$

1 mole of alum reacts with 3 moles of alkalinity

$$\begin{aligned}
 \text{Therefore the mass of alum to react with alkalinity} &= 19,4 \times 666 / (3 \times 162,1) \\
 &= 26,6 \text{ mg/l alum}
 \end{aligned}$$

The amount of alum remaining = $55 - 26,6 = 28,4 \text{ mg/l}$

MW of $\text{Ca}(\text{OH})_2 = 40 + 2(16 + 1) = 74$

MW of $\text{CaO} = 40 + 16 = 56$

1 mole of alum reacts with 3 moles of $\text{Ca}(\text{OH})_2$

$\text{Ca}(\text{OH})_2$ required = $28,4 \text{ mg/l alum} \times (3 \times 74)/666 = 9,48 \text{ mg/l Ca}(\text{OH})_2$

$9,8 \text{ mg/l Ca}(\text{OH})_2 \times 56/74 = 7,2 \text{ mg/l CaO}$

Example 3:

The FeCl_3 dosage determined from jar tests for a certain water source is 20 mg/l . What must the dosage rate be in ml/min of FeCl_3 for a dosage of 20 mg/l FeCl_3 . The FeCl_3 is provided as a 43% solution (mass FeCl_3 /mass solution) with a density of $1,48 \text{ kg/l}$. The flow to the plant is $5000 \text{ m}^3/\text{h}$.

Approach: The dosage in mg/l (mass of pure FeCl_3 /volume water) must be converted to dosage in ml/min (volume of 43% FeCl_3 solution/time). This means the mass pure FeCl_3 /volume dosage must first be converted to mass of 43% solution and then to volume of $1,48 \text{ kg/l}$ solution. This step is followed by converting volume/volume to volume/time by multiplying with the volumetric flow rate.

Step 1: Convert the dosage in mg/l pure FeCl_3 to mg/l FeCl_3 solution.

20 mg FeCl_3 is contained in $20/0,43 \text{ mg solution} = 46,5 \text{ mg solution}$ ($46,5 \times 43/100=20$)

Step 2: Convert mg solution to ml solution .

$46,5 \text{ mg solution} = 46,5 \text{ mg} \times 1/1,48 \text{ ml/g} \times 1/1000 \text{ g/mg} = 0,0314 \text{ ml solution}$.

$20 \text{ mg/l FeCl}_3 = 46,5 \text{ mg/l solution} = 0,0314 \text{ ml/l solution}$

Step 3: Convert $\text{ml solution/l water}$ to $\text{ml solution per minute}$. This means we have to take into account conversion of m^3 to litre ($1 \text{ m}^3 \times 1000 \text{ l/m}^3$) and conversion of ml to litre ($1 \text{ ml} \times 1/1000 \text{ l/ml}$) and conversion of hours to minutes ($1 \text{ hr} \times 60 \text{ min/hr}$). It is most important to make sure that the units are consistent and that they cancel out to give the required units.

$0,0314 \text{ ml solution/l water} \times 1000 \text{ l/m}^3 \text{ water} = 31,4 \text{ ml solution/m}^3 \text{ water}$

$31,4 \text{ ml solution/m}^3 \text{ water} \times 5000 \text{ m}^3 \text{ water/hr} \times 1/60 \text{ hr/min} = 2616,7 \text{ ml solution/min}$

Dosage is $2616,7 \text{ ml FeCl}_3$, solution per minute for a flow of $5000 \text{ m}^3/\text{hr}$

Step 2: Convert the dosage in mg FeCl₃ solution per litre water to ml FeCl₃ solution per litre H₂O

$$101,46 \text{ mg/l solution} = [101,46 \text{ mg solution/l H}_2\text{O}] \times [1 \text{ ml soln./ 1 480 mg soln.}]$$
$$= 0,069 \text{ ml soln./litre H}_2\text{O}$$

soln. = solution

Alternative

The problem may also be stated that a dosage of 10 mg/l as Fe³⁺ is required for coagulation. Calculate the dosage for the same conditions given above.

Approach: In this case one first has to convert mg/l Fe³⁺ to mg/l FeCl₃ and then follow the same procedure as for the example above.

Step 1: Convert mg/l Fe³⁺ to mg/l FeCl₃ : FeCl₃ → Fe³⁺ + 3 Cl⁻

[1 mmol FeCl₃ (Mol mass 162,3) gives 1 mmol Fe³⁺ (Mol mass 55,8)]

$$12 \text{ mg Fe}^{3+}/\text{l H}_2\text{O} = (12 \text{ mg Fe}^{3+}/\text{l H}_2\text{O}) \times (1 \text{ mmol FeCl}_3 / 1 \text{ mmol Fe}^{3+}) \times$$
$$(1 \text{ mmol Fe}^{3+}/55,8 \text{ mg Fe}^{3+}) \times (162,3 \text{ mg FeCl}_3 / 1 \text{ mmol FeCl}_3)$$
$$= 34,9 \text{ mg FeCl}_3 / \text{l H}_2\text{O}$$

Step 2: Convert mg FeCl₃ per litre water to mg FeCl₃ solution per litre water as above.

$$34,9 \text{ mg FeCl}_3 / \text{l H}_2\text{O}] \times [100 \text{ mg solution}/43 \text{ mg FeCl}_3] = 81,16 \text{ mg solution per l water}$$

Step3: Convert mg solution per litre water to ml solution per litre H₂O

$$81,16 \text{ mg solution/l H}_2\text{O} \times 1 \text{ ml sol./ 1 480 mg sol} = 0,0548 \text{ ml sol./litre H}_2\text{O}$$

Step 4: For 5000 m³/h: 0,0548 ml sol./litre H₂O x 5000 m³/h x 1000 l/ m³ x 1hr/60 min

$$= 4569,9 \text{ ml soln./min}$$

Example 4:

Calculate the solubility of Ca^{2+} (aq) in a saturated CaSO_4 solution in water in mg/l if the $K_{sp} = 1.9 \times 10^{-4}$

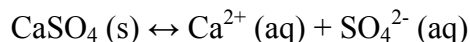

For each mole of $\text{CaSO}_4 (\text{s})$ that dissolves, one mole of $\text{Ca}^{2+} (\text{aq})$ and one mole of $\text{SO}_4^{2-} (\text{aq})$ are formed

$$K_{sp} = [\text{Ca}^{2+}] [\text{SO}_4^{2-}] = 1.9 \times 10^{-4}$$

Say the molar concentration of each ion = y , then

$$y^2 = 1.9 \times 10^{-4}$$

$$y = 0.0138 \text{ mole/l}$$

1 mole of $\text{Ca}^{2+} = 40 \text{ g/mole}$, so

$$y = 0,0138 \text{ mole/l} \times 40 \text{ g/mole} = 0,552 \text{ g/l or } 552 \text{ mg/l}$$

The concentration of calcium and carbonate at equilibrium can be calculated as follows:

$$K_s = [\text{Ca}^{2+}] [\text{CO}_3^{2-}] = 4,7 \times 10^{-9}$$

Since 1 mole of calcium reacts with 1 mole of carbonate we can write:

$$[\text{Ca}^{2+}] [\text{CO}_3^{2-}] = [\text{Ca}^{2+}]^2 = 4,7 \times 10^{-9}$$

$$[\text{Ca}^{2+}] = 0,0000686 \text{ mol / } \ell$$

$$\text{Ca}^{2+} = 0,0000686 \times 40,08 \times 1\,000 \text{ mg/}\ell$$

$$\text{Ca}^{2+} = 2,75 \text{ mg/}\ell$$

This is the theoretical maximum value of the ions in solution before precipitation will commence. In practice however, these low values are not easily achieved. The solubility behaviour of most slightly soluble salts is much more complicated than is suggested by this example. Complex formation, hydrolysis, pH and other phenomena have important effects on solubility behaviour.

Example 5:

Calculate the residual magnesium concentration that exists in a saturated magnesium hydroxide solution if enough sodium hydroxide has been added to the solution to increase the equilibrium pH to 11.0.

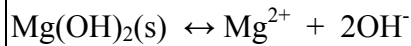

The solubility product constant for this reaction $K_{\text{sp}} = 1,2 \times 10^{-11}$.

Determine the hydroxide ion concentration:

$$K_w = [\text{H}^+][\text{OH}^-] = 10^{-14} \text{ at } 25^\circ\text{C}$$

Because the pH is 11, $[\text{H}^+] = 10^{-11} \text{ mol/l}$
we know that

$[\text{OH}^-] = 10^{-14} / 10^{-11} = 10^{-3} \text{ mol/l}$ Establish the solubility product constant expression, and solve for the magnesium ion concentration:

$$K_{\text{sp}} = [\text{Mg}^{2+}][\text{OH}^-]^2$$

$$\begin{aligned} [\text{Mg}^{2+}] &= 1,2 \times 10^{-11} / (10^{-3})^2 \\ &= 1,2 \times 10^{-5} \text{ mol/l or } 0,29 \text{ mg/l} \end{aligned}$$

Since hardness ion concentrations are normally expressed as CaCO_3 , multiply the concentration by the ratio of the equivalent weights:

$$0,29 \times 50 / 12,2 = 1,2 \text{ mg/l as } \text{CaCO}_3$$

An example of a redox reaction is the oxidation by chlorine of soluble manganese (ii) and the subsequent removal of manganese by precipitation of manganese (iv) dioxide. Some elements such as iron and manganese may have different oxidation numbers depending on the compound or the reaction in which it is involved. The oxidation number is calculated on the basis that the net charge of a molecule must be zero, and of an ion must be the charge that the ion carries. For example, the oxidation number of manganese in MnO_2 is +4 because the oxidation number of oxygen is always -2 and since there are 2 O atoms for each Mn atom $[2 \times (-2) = (-4)]$

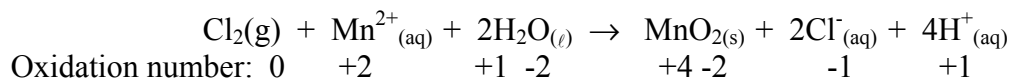

Electrons are negatively charged entities. This means that when an atom loses one electron, it loses one negative charge, or gains one positive charge. Manganese loses 2 electrons per Mn atom when changing from the +2 state in Mn^{2+} to the +4 state in MnO_2 . Since oxidation is defined as a loss of electrons Mn^{2+} is oxidized to the +4 state. Chlorine on the other hand gains one electron per atom when changing from molecular chlorine to the chloride ion and is therefore reduced in the process. Chlorine is the oxidising agent that oxidises manganese and in the process chlorine is reduced. Since electrons cannot be destroyed, the total gain in electrons must always

equal the total loss in electrons. The 2 electrons lost by Mn^{2+} equal the 2 electrons gained by the 2 chlorine atoms, each gaining one electron.

Example 6:

Chlorine gas (Cl_2) is often used as oxidant in water treatment for oxidation and removal of iron and manganese. The equations for the oxidation and reduction reactions taking place when Mn^{2+} is oxidised to MnO_2 and Fe^{2+} is oxidised to Fe^{3+} respectively by Cl_2 are standard half reactions for the oxidation and reduction reactions. The overall balanced reactions can be written by adding the respective half reactions:

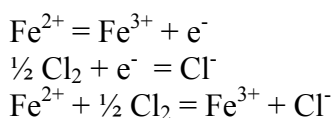
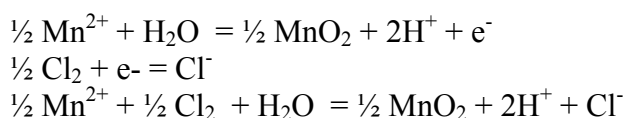

Calculate the theoretical amount of Cl_2 required to oxidise Fe^{2+} to Fe^{3+} . Give the answer in mg/l Cl_2 per mg/l Fe^{2+} .

$$\begin{aligned} &0,5 \text{ mole } \text{Cl}_2 \text{ per } 1 \text{ mole of } \text{Fe}^{2+} \\ &0,5 * 2 * (35,45) \text{ mg/l } \text{Cl}_2 \text{ per } 55,85 \text{ mg/l } \text{Fe}^{2+} \\ &= 35,45 \text{ mg/l } \text{Cl}_2 \text{ per } 55,85 \text{ mg/l } \text{Fe}^{2+} \\ &= 0,6347 \text{ mg/l } \text{Cl}_2 \text{ per mg/l } \text{Fe}^{2+} \end{aligned}$$

Calculate the amount of acidity produced in the reaction as mg/l H^+ per mg/l Mn^{2+} oxidised. The H^+ reacts with natural alkalinity in the water (HCO_3^-). Write the equation for this reaction and calculate the amount of alkalinity destroyed by the oxidation of Mn^{2+} . Give the answers for acidity produced and alkalinity destroyed in mg/l CaCO_3 per mg/l Mn^{2+} oxidised.

$$\begin{aligned} &4 \text{ moles } \text{H}^+ \text{ produced per mole Mn oxidised} \\ &4 \text{ mg/l } \text{H}^+ \text{ per } 54,94 \text{ mg/l Mn oxidised} \\ &= 0,0728 \text{ mg/l } \text{H}^+ \text{ per mg/l Mn} \\ &= 0,0728 * 50/1 \\ &= 3,64 \text{ mg/l } \text{CaCO}_3 \text{ per mg/l Mn} \end{aligned}$$

$$\begin{aligned} &\text{H}^+ + \text{HCO}_3^- = \text{H}_2\text{CO}_3 \\ &1 \text{ mol } \text{HCO}_3^- \text{ per mol } \text{H}^+ \\ &= 61 \text{ mg/l } \text{HCO}_3^- \text{ per mg/l } \text{H}^+ * 0,0728 \text{ mg/l } \text{H}^+ \text{ per mg/l Mn} \\ &= 4,44 \text{ mg/l } \text{HCO}_3^- \text{ per mg/l Mn} \\ &= 4,44 * 50/61 \\ &= 3,64 \text{ mg/l } \text{CaCO}_3 \text{ per mg/l } \text{Mn}^{2+} \end{aligned}$$

Experimental studies showed that a dosage of 2,1 mg/ℓ as HOCl is required for effective oxidation of iron and manganese in a groundwater. The chlorine is purchased as a solution containing 15% NaOCl with a specific gravity of 1,12 g/mℓ. Determine the dosage rate (mℓ/min) for a dosage of 2,1 mg/ℓ HOCl for a small treatment plant with a flow of 1200 m³/day if the NaOCl is diluted 1:5 (volume basis) before dosage.

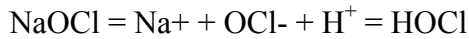

$$1 \text{ mol HOCl} = 1 \text{ mol NaOCl}$$

$$52,45 \text{ mg/l HOCl} = 74,45 \text{ mg/l NaOCl}$$

$$2,1 \text{ mg/l HOCl} = 2,1 \text{ mg HOCl/l} * 74,45 \text{ mg NaOCl} / 52,45 \text{ mg HOCl/l}$$

$$= 2,98 \text{ mg/l NaOCl}$$

$$2,98 \text{ mg NaOCl/l} * 100 \text{ mg soln} / 15 \text{ mg NaOCl} * 1200 \text{ m}^3/\text{day} *$$

$$1 \text{ day} / 24 \text{ hr} * 1 \text{ hr} / 60 \text{ min} * 1000 \text{ l/m}^3 * 1000 \text{ mg/g}$$

$$= 16,556 \text{ g NaOCl/min}$$

$$= 16,556 \text{ g NaOCl/min} * 1 \text{ ml soln} / 1,12 \text{ g soln}$$

$$= 14,782 \text{ ml soln/min undiluted}$$

$$= 14,782 + 5 * 14,782 = 88,69 \text{ ml/min diluted NaOCl}$$

MASS BALANCE CALCULATIONS

Introduction

In water treatment processes and plant the flow of water and of material is of primary importance. The reason is that it is important to account for water and chemicals usage and production of wastes. It is even more important in industry to account for the raw material and water used in order to determine how much material is converted to product and how much ends up as waste and how the measured concentration of waste streams compare with measured values. The only way that these types of questions can be answered is by means of compiling mass and water balances.

The principles of conservation of mass form the basis of mass balance calculations. Material cannot be created or destroyed; it only changes form. The transport of material may be expressed as volumetric flow rate, such as mega litres per day or litres per hour, or in terms of mass flow, such as tons per hour, grams per second, or kg moles per hour. It is very important in mass balance calculations to ensure that units are consistent. This is normally achieved by writing down the units of every component as well of units to convert different sets of units to the same basis. This is illustrated in the examples below.

CONSERVATION OF MASS

The law of conservation of mass implies that material is neither created nor destroyed during normal activities of man and nature (with exception of nuclear reactions). All the mass that enters an enclosed region must either leave the region or accumulate in it.

This is expressed as follows:

$$(\text{total mass in}) - (\text{total mass out}) = (\text{accumulation of mass in the region})$$

If there is no conversion of a particular species into other species by chemical or biological transformation, the conservation of that species can be expressed as:

$$(\text{total species } i \text{ in}) - (\text{total species } i \text{ out}) = (\text{total accumulation of species } i)$$

It is often convenient to deal with mass flow rates. The conservation laws then take on the form:

$$(\text{total rate of mass flow in}) - (\text{total rate of mass flow out}) = (\text{rate of accumulation of mass in the region})$$

$$(\text{total rate of flow of species } i \text{ in}) - (\text{total rate of flow of species } i \text{ out}) = (\text{rate of accumulation of species } i)$$

The special case where there is no accumulation or depletion is called steady state:

$$(\text{total rate of mass flow in}) = (\text{total rate of mass flow out})$$

GUIDELINES TO DEVELOP A MATERIAL BALANCE

The following can be used as general guidelines to solve a mass balance problem:

- Draw a diagram or a flow sheet for the problem and show all the known quantities and streams as well as flows and concentrations.
- Decide on the basis for solving the problem, e.g. a time interval such as one hour or one day, or a specific input such as 1000 m³ or 1000 kg.
- Identify the components. A tie component is an element, molecule, or kind of material that goes through the system unchanged. Dry air, water, or an inert solid can be used as a tie component.
- Select the boundaries of the region over which the material balances will be made. It is often necessary to select more than one region with different boundaries in order to calculate one component in one region that can be used as input to another region.

The following examples show different mass balance applications:

Example 7:

A simple mass balance problem is one that only involves one component such as water. In this example we consider only one component involving the change in water level of a storage tank over time. A storage tank with a surface area of 25 m² (5m x 5m) receives a steady inflow of 80 l/s, while the average demand (outflow) is 20m³ per day. By how much will the water level change after 5 days?

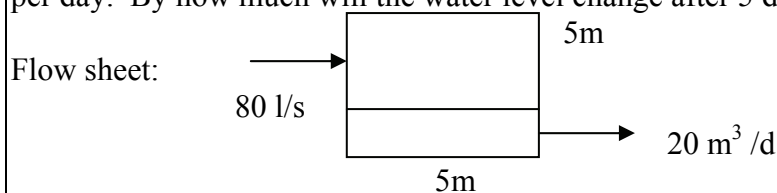

Boundaries are from inlet to outlet

Basis is 5 days

$$\text{Inflow} - \text{outflow} = \text{accumulation}$$

We have to convert the different units to the same basis to allow addition and subtraction of volumes.

$$\begin{aligned}\text{Inflow} &= 2 \text{ l/s, convert this to m}^3 \text{ in 5 days} \\ &= 2 \text{ l/s} * 1/1000 \text{ m}^3/\text{l} * 60/1 \text{ s/min} * 60/1 \text{ min/h} * 24 \text{ h/d} * 5 \text{ d} \\ &= 864 \text{ (1 * m}^3 * \text{s * min * h * d) / (s * l * min * h * d)} \\ &= 846 \text{ m}^3\end{aligned}$$

$$\begin{aligned}\text{Outflow} &= 200 \text{ m}^3/\text{d} * 5 \text{ d} \\ &= 1000 \text{ m}^3\end{aligned}$$

$$\begin{aligned}\text{Accumulation} &= \text{inflow (846 m}^3) - \text{outflow (1000 m}^3) \\ &= -136 \text{ m}^3 \text{ (negative accumulation is depletion, i.e. a drop in level)}\end{aligned}$$

We know the loss in volume and the area of the tank ($5\text{m} \times 5\text{m} = 25 \text{ m}^2$) and can therefore calculate the height, i.e. drop in level

$$\text{Drop in level} = 136 \text{ m}^3 / 25 \text{ m}^2 = 5,44$$

Example 8:

If we wish to calculate the concentration of dissolved components in the water, the problem becomes more complex. In this example we calculate the area of an evaporation dam into which the concentrate from a reverse osmosis (RO) plant is disposed of and we calculate the concentration of the brine after a certain period.

An RO plant produces 150 m^3 of brine per day that is disposed of in an evaporation dam. The average precipitation (rainfall) for the area is 800 mm per year and the average rate of evaporation is 1400 mm per year. What must the area of the evaporation dam be, in order that the level of brine does not rise by more than 500 mm per year. If the TDS concentration in the brine is 8500 mg/l , what will the concentration be after two years?

Boundaries are the evaporation dam

Basis is 1 year (could also be 1 day, but rainfall and evaporation figures are normally given as averages per year)

$$\begin{aligned}\text{Inflow} &= \text{brine inflow} + \text{rainfall} \\ \text{Brine} &= 150 \text{ m}^3/\text{d} * 365 \text{ d/year} = 54750 \text{ m}^3/\text{year} \\ \text{Rainfall} &= 800 \text{ mm/year} * 1/1000 \text{ m/mm} * \text{Area (A)} = 0,8 \text{ A m}^3\end{aligned}$$

$$\text{Outflow} = \text{evaporation} = 1400 \text{ mm/year} * 1/1000 \text{ m/mm} * A = 1,4A \text{ m}^3$$

$$\text{Maximum accumulation} = 0,5 \text{ m/yr} * A \text{ m}^2 = 0,5A \text{ m}^3 = \text{inflow} - \text{outflow}$$

$$\text{Accumulation} = \text{inflow} - \text{outflow}$$

$$0,5 A \text{ m}^3 = (54750 \text{ m}^3 + 0,8A \text{ m}^3) - (1,4A \text{ m}^3)$$

$$0,5 A = 54750 - 0,6 A$$

$$1,1 A = 54750 \text{ m}^3$$

$$A = 49772,73 \text{ m}^2$$

The area of the dam must not be less than 49772,73 m², say 50000 m²

$$50000 \text{ m}^2 = 50000 \text{ m}^2 * 1/10000 \text{ ha/m}^2 = 5 \text{ hectares}$$

The second part involves calculation of concentration, i.e. mass per volume. This means we have to calculate the mass of solids as well as the volume after 1 year. We assume that the dam is empty and we start putting brine into the dam on day 1.

We have already calculated the volume of brine that will be discharged into the dam as 54750 m³ per year.

The mass flow of TDS is calculated by multiplying the volume flow (m³ /yr) by the concentration (g/m³), which gives the mass flow in g/yr. To convert to kg/yr: g/yr*1/1000kg/g.

Note: Concentration in mg/l is numerically the same as g/m³ and as kg/MI

$$\text{TDS mass flow} = 54750 \text{ m}^3 / \text{yr} * 8500 \text{ g/l} = 465375000 \text{ g/yr or}$$

$$= 465375000 \text{ g/yr} * 1/1000 \text{ kg/g}$$

$$= 465375 \text{ kg/yr}$$

The volume of water in the dam after 1 year = dam area * rise in level

$$= 49772,73 \text{ m}^2 * 0,5 \text{ m}$$

$$= 24886,4 \text{ m}^3$$

The TDS concentration in the dam after 1 year is therefore mass/volume

$$= 465375000 \text{ g} / 24886,4 \text{ m}^3$$

$$= 18700 \text{ g/m}^3 = 18700 \text{ mg/l}$$

PART B TREATMENT PROCESSES

CHAPTER B1: COAGULATION AND FLOCCULATION

Ian Morrison

INTRODUCTION

There are, as far as water treatment is concerned, two broadly different types of water, one containing predominately suspended particles, visible and/or colloidal, and the other, dissolved materials, brown in colour. Each of these types has variations on the theme.

Many inland sources are predominantly clay-bearing during the summer but in the winter contain rather less clay and more algae and other organic materials. For example, the water from the Vaal River, downstream of the Barrage, contains clay, organic materials, and high TDS.

The brown waters of the Cape range from the very pale Wemmershoek water to the very dark waters of Simonstown and George.

In all cases, the object is to:

1. Destabilise this foreign colloidal matter so as to incorporate it in the form of a floc. This is known as the coagulation or rapid mixing stage.
2. Allow the floc, so formed, to grow in size by stirring slowly so that it may settle out. This is the flocculation stage.

CLAY AND SILICA BEARING WATERS

Clay particles are very small colloidal crystalline materials (10^{-5} - 10^{-2} mm), which are the result of weathering of granite and other rocks at some stage of their existence.

They carry electrical charges, which may be positive or negative, usually the latter. These result in unbalanced charges at their surfaces.

One can picture these crystals as having, on the solid side, sheets of charged particles held in close proximity to each other. On the liquid side, there is an assortment of other ions not held in fixed positions and of much lower concentration. It is at the border between the two that the imbalance in charge results.

Now, like charges repel each other, and therefore small particles, which in any case settle only slowly, can remain in suspension for long periods, ranging from hours to months or years. Similarly colloidal silica particles (very fine sand) can also be suspended for long periods.

Ordinary salt, NaCl, in sufficient amount can, by shielding the particles from each other, reduce the settling time to a matter of minutes. This is known as the salting out effect.

More practically, these particles may also be destabilised by the addition of the salts of aluminium or ferric iron. The salts of these metals form insoluble precipitates (within a given pH range), which will, after 10-30 minutes or so of stirring, gather together the clay and silica and settle out.

There is also a range of other chemicals known as polymeric compounds which can be used to destabilise the particles but they are not as commonly used. (See section on Destabilisation of Clay and Silica by Polymeric Compounds)

Destabilisation of Clay and Silica by Metal Salts

When dosed into alkaline or slightly acid water, metals salts such as aluminium sulphate, ferric chloride and sulphate, combine with hydroxide ions from the water, giving rise to a series of charged ions, containing several metal ions, all of the same metal, before being precipitated as insoluble metal hydroxide, $\text{Al}(\text{OH})_3$ or $\text{Fe}(\text{OH})_3$.

These multi-charged ions play a large part in destabilising the clay and silica but only occur for a second or two during the mixing process. Consequently, the rate of mixing is an important process parameter. If too slow, floc formation in the dosed water will also be slow as there will be non-destabilised particles present that will not easily be incorporated into the floc.

The necessary hydroxide ions have also to be present in the water, either added before or after or already present. In this connection the important factor is the final pH. Choose a final pH that gives a low Al or Fe content.

The effective dose has to be experimentally determined. (See section on Jar Tests.)

Destabilisation of Clay and Silica Particles by Polymeric Compounds

Alternatively, there is a range of chemicals known as polymeric compounds, which are large molecules having charges already built into them. All polymeric compounds are dealt with together here.

Polymeric compounds are large organic molecules containing multiple charged groups. The charged groups attach themselves to the surfaces of particles thereby holding them together and causing them to coagulate.

The charges on the groups may be positive (cationic) or negative (anionic). They are available in a range of strengths. One can imagine a scale with strongly cationic at one end, passing through weakly cationic and weakly anionic to strongly anionic, at the other end.

Not all polymeric compounds are effective with any given water, but with those that are, the following pattern is generally found: At low doses there is little effect, then there is a zone in which destabilisation occurs followed by one where the floc once again re-disperses. This behaviour is caused by charge reversal ie as the dose is gradually increased the charge on the particles is reduced until it is zero and then increases again in the opposite direction.

In the region where the surface charge is close to, but not exactly zero, coagulation happens. This point has to be experimentally determined. (See section on Jar Tests.)

The great advantage of polymeric compounds over metal salts is that they are nearly neutral and so do not change the pH of the water much.

Destabilisation of Clay and Silica by Poly-Aluminium Chloride (PAC)

Poly-aluminium chloride is pre-formed, usually in a factory, by partly neutralising aluminum chloride, but stopping short of the fully neutralised state. When finally dosed at the treatment plant a large proportion of the aluminum is in the favourable polymeric state.

It is often mixed with other polymeric compounds, thereby combining the virtues, but also the disadvantages of each material.

BROWN WATER

The brown colour in the soft coastal waters between Vredendal and just short of Port Elizabeth (and one or two places further North), is caused by large charged organic molecules known as humic acids or humic materials.

These come in a range of sizes from colloidal to dissolved matter and arise from the degradation of plant materials.

Humic acids are usually a mixture of chemicals. They are mostly composed of 6-membered rings of carbon atoms with attached acidic (-COOH) and phenolic (-OH) groups. Smaller organic particles, known as fulvic acids are also present. The distinction between the two types is not clear and may mainly be one of size.

The acidic groups are weakly bound, meaning that the hydrogen ions separate quite easily from the rest, giving rise to negatively charged ions (the big part) along with the positively charged hydrogen ions (the small part). These charged ions are soluble in water, the solubility increasing if the pH is increased and vice-versa.

The treatment in these waters is in practice very similar to those containing clay and silica, but is chemically somewhat different, involving a co-precipitation reaction rather than surface charge neutralisation. The same chemicals are involved, however.

Destabilisation of Humic Materials by Metal Salts

When iron or aluminum salts are added to acid brown water in sufficient amount, a precipitate is formed, which includes the brown matter. Because brown waters are usually lacking in alkali, an alkaline substance, such as lime or sodium carbonate, has also to be added to provide the necessary hydroxide ions. This can be done either before or after the metal, depending on which gives the better result.

Let us follow the effect of gradually increasing the dose, in each case after the pH has been adjusted to the same constant value. The turbidity is then measured, after settlement, and the ultra-violet absorbance, UV254, after filtration (UV254 is related to colour and its measurement is described below).

At first nothing much happens, other than an increase in turbidity. But as more metal salt is added, the point is reached where precipitation starts and there is a fairly rapid decrease in both measured values. This is succeeded by one of low and relatively constant values. The bottom part of the curve is the part of interest. (Figure B1.1).

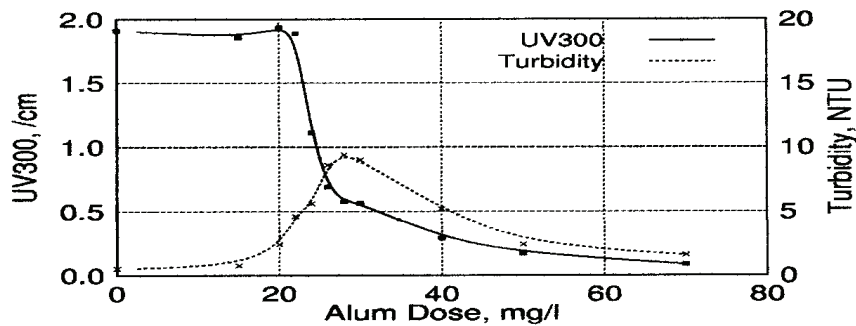

Figure B1.1: Effect of aluminium sulphate dose on brown water at pH 5.4

There is a corresponding set of curves for pH values at constant doses. These have minimum values between pH 4.5 to 7.0 (Figure B1.2).

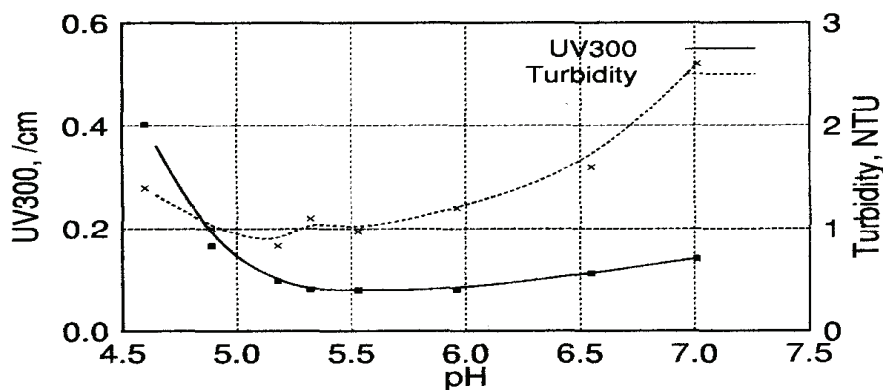

Figure B1.2: Effect of coagulation pH on brown water (Aluminium sulphate dose 90 mg/l)

The process may be considered to be one of adjustment of pH to near the point of minimum solubility of the metal. Choose a pH which gives a low residual metal content.

The intensity of rapid mixing is not as important as with clay bearing waters.

At some plants sodium aluminate (alkaline) replaces some of the alum (acidic), with a little lime being added for final pH control. The aluminum content of sodium aluminate is three times that of alum and a good ratio to use is 1 part sodium aluminate to five parts alum.

FLOC FORMATION IN BOTH TYPES OF WATER

Once destabilisation has occurred, floc formation has commenced. It may be speeded up by stirring. Rapid stirring is usually employed at first, followed by more a more gentle approach. The overall process is termed tapered flocculation. Some ten to thirty minutes are required for the floc to develop to near the full extent.

The measure of the intensity of stirring usually used is known as the G value. G is not measured directly but is calculated, either using a factor taken from a table or from the formula:

$$G = (P / (\mu.V))^{1/2}$$

where

$$G = \text{velocity gradient, s}^{-1}$$

$$P = \text{power dissipated, kg m}^2 \text{ s}^{-3}$$

$$\mu = \text{viscosity of the water, kg m}^{-1} \text{ s}^{-1}$$

$$V = \text{volume of reactor, m}^3$$

FACTORS THAT AFFECT THE PROCESS

Clay and Silica Bearing Water

The first and most important factor is the dose of the coagulant. Sufficient chemical has to be added to more or less neutralise the surface charge on the clay and silica. The sign to look for is the appearance of the water between the flock particles. A clear water rather than a murky one is the desired result, at the end of the flocculation stage.

The next factor is pH. In many cases, the water will be sufficiently well buffered so as not to need any pH adjustment.

Buffering is generally provided by bicarbonate ions (HCO_3^-), which in turn decompose to provide hydroxide ions - if the buffer capacity is small the pH may be out of the desired range by the time enough coagulant has been added. Where pH adjustment is required, slaked lime or sodium carbonate is usually employed.

The third factor is intensity of stirring, as measured by G (see previous Section), and the fourth, time (t). The effect of G on the time to give a constant turbidity can be directly measured. At high G values (100 or more), the turbidity falls rapidly but the resultant constant turbidity is generally high, while at G of 20 or 30 it takes longer to

get there but the constant turbidity is much lower. Between these limits there is space for more in-between values of G, either stepwise or gradual, giving tapered flocculation, starting with high G and ending with low G.

Brown Water

In the case of brown waters, coagulant dose and pH are nearly equal in importance. The coagulant is almost always a metal salt, except that if the colour is low a PAC can be used (see section on Treatment Chemicals). One has to add enough coagulant to remove the bulk of the colour. The amount required is predictable and depends on the UV254 absorbance of the raw water.

UV254 absorbance may be measured, in a spectrophotometer, by passing a beam of ultra-violet light, of wavelength 254 nm, through a cell of known size and measuring the intensity of the light coming out at the other end. The scales on the instruments usually include absorbance.

Table B1.2 gives the required doses. If a spectrophotometer is not available, an alternative measure of organic matter can be used, but this is less desirable.

Table B1.1 PROPERTIES OF COMMONLY USED CHEMICALS

CHEMICAL	APPEARANCE	USE	SOLUBILITY Amount g dissolving in 1 litre water at 20 °C	FORMULA
Aluminium sulphate, Alum	White or brown kibbles, granules or powder.	Acidic flocculant	870	$Al_2(SO_4)_3 \cdot xH_2O$ Al = 0.090 x Alum
Ferric sulphate	Brown solution	Acidic flocculant	Depends on pH	$Fe_2(SO_4)_3$
Ferric chloride	Yellow brown solution	Acidic flocculant	740	$FeCl_3$
Poly-ferrates	Liquid	Mildly acidic flocculant		
Sodium aluminate	White powder	Alkaline flocculant	Very soluble	$NaAlOH$
Poly aluminium chloride, PAC	Liquid	Near neutral flocculants		
Poly-electrolytes	White powder	Near neutral flocculants		
Poly-amines	Liquid	Near neutral flocculants		
Dimdacs	Liquid	Near neutral flocculants		
Quick lime, Burned lime	Usually lumps	Alkaline. pH control.	1.3	CaO
Slaked lime	Fine powder	Alkaline. pH control	1.7	$Ca(OH)_2$
Sodium carbonate, Washing soda	Crystals or powder	Alkaline pH control	210	Na_2CO_3
Sodium hydroxide, Caustic soda	Crystals	Alkaline pH control	1090	NaOH

The pH for best removal ranges from 4.5 to 7 for iron salts, and 5.4 to 6.5 or 7 for aluminum salts. The darker waters generally require a pH at the lower end of the scale.

As SANS 241 requires a low aluminum content in the treated water it means that, as iron salts have a low aluminum content (or should have if the specification has been correctly worded), they are the chemicals of choice, since it is easier to get a low aluminum value by their use.

This does not entirely exclude the use of aluminum salts in the treatment of brown waters as, in favourable cases, it is possible to achieve a low residual aluminum content even with aluminum flocculants.

It should be noted that, when doing jar tests, very occasionally the effect of pH, as measured at a central laboratory, will differ from that measured at the treatment plant - usually as a result of the age of the water, the plant sample being fresher than that taken for the laboratory.

The remaining factors are stirring, as measured by G, and time. G usually starts off in the range of about 100 s^{-1} or more, at the rapid mixing stage, and tapers off to about $15 - 25 \text{ s}^{-1}$ in the slow mixing section of the plant. (See discussion on G and stirring time at the end of the previous section).

TREATMENT CHEMICALS

The chemicals used in flocculation are acidic, alkaline (basic) or approximately neutral. The water that is being treated may also be acidic, alkaline or neutral. Acids and alkalis neutralise each other. Therefore, various combinations of chemicals are used, in order to achieve the desired coagulation pH.

The effect of the coagulation pH on the solubility of aluminum is shown by Figure B1.3. The corresponding graph for iron is not given as it is much below that of aluminum for pH values between 4 and 8.

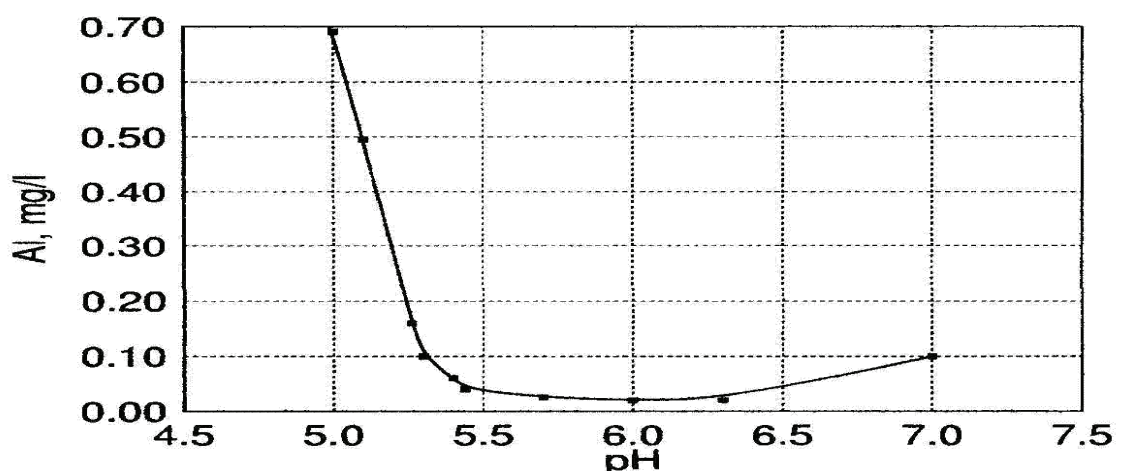

Figure B1.3: Effect of pH on solubility of Al (Aluminium sulphate dose 90 mg/l)

Table B1.1 summarises the essential properties of the most commonly used chemicals.

Table B1.2: Calculation of recommended coagulation dosage

1. Use any available measure of organic content, given in order of preference in the table below.
2. In the case of DOC, COD or Colour make the adjustment given at the head of the column.
3. Read off the dosage factor, expressed in the units normally used for dosage calculations.
4. Calculate: Dosage = Factor x Adjusted Measure of Organic Content

COAGULANT	MM	RECOMMENDED DOSING FACTOR based on:				
		UV254	UV300	DOC - 1.5	COD + 1.8	COL-OUR +47
Any ferric iron chemical:						
expressed as mg/l Fe	55.85	18.9	30	1.33	0.434	0.078
expressed as mg/l FeCl ₃	162.2	54.8	87	3.86	1.26	0.225
expressed as mg/l Fe ₂ (SO ₄) ₃	399.9	67.4	107	4.75	1.55	0.276
Any aluminium chemical:						
expressed as mg/l Al	26.98	9.13	14.5	0.644	0.210	0.0374
expressed as mg/l Alum (17% Al ₂ O ₃)	599.8	102	161	7.16	2.33	0.421
expressed as mg/l Al ₂ (SO ₄) ₃ .18H ₂ O	666.5	112	179	7.95	2.59	0.462
expressed as mg/l Al ₂ (SO ₄) ₃	342.1	59.9	95	4.22	1.37	0.245
expressed as mg/l Al ₂ O ₃	102.0	17.3	27.4	1.22	0.396	0.071
expressed as mg/l AlCl ₃	133.3	45.1	72	3.20	1.04	0.186

NOTES:

1. UV254 is the absorbance of filtered raw water, at a wavelength of 254 nm in a 10 mm cell.
2. UV300 is the absorbance of filtered raw water, at a wavelength of 300 nm in a 10 mm cell.
3. DOC is the concentration of dissolved organic carbon in filtered raw water, as mg/l C.
4. COD is the chemical oxygen demand of filtered raw water, as mg/l O.
5. Colour is the colour of filtered raw water, as platinum or Hazen units.
6. Conversion equations for raw waters.

$$\begin{aligned}
 \text{UV300} &= 0.630 \times \text{UV254} \\
 \text{UV300} &= 0.0444 \times (\text{DOC} - 1.51) \\
 \text{UV300} &= 0.01447 \times (\text{COD} + 1.83) \\
 \text{UV300} &= 0.00258 \times (\text{Colour} + 47)
 \end{aligned}$$

Aluminium Sulphate (Alum)

Alum is usually dosed in the form of a solution, of about 80 g/l concentration, and then forms, under appropriate conditions white or brown floc, depending on the impurity being removed.

Ferric Sulphate.

Ferric sulphate is usually dosed in the form of a solution, of about 135 g/l Fe concentration, and then forms, under appropriate conditions, a brown floc.

Ferric Chloride. FeCl₃

Ferric chloride is usually dosed in the form of a solution, and then forms, under appropriate conditions, a yellow brown floc. Ferric chloride is very corrosive, dissolving stainless steel in a matter of hours, but can be handled by the use of plastic materials.

Sodium Aluminate

Sodium aluminate is usually dosed in the form of a solution, of concentration about 20 g/l Al, and then forms, under appropriate conditions, a white or brown floc, depending on the impurity being removed. It has the advantage of being one of the few alkaline flocculants and can be combined with acidic alum and possibly some lime to give the desired pH.

Poly Aluminium Chloride (PAC)

This chemical is partly neutralised aluminium chloride. It may also be mixed with poly-electrolytes. It is a nearly neutral solution and when added to water, it produces white or brownish flocs.

Poly-amines

Liquid poly-electrolytes which form white or brown flocs when added to water.

Dimdacs

Liquid poly-electrolytes which form white or brown flocs when added to water.

Poly-ferrates

Partly neutralised iron solutions which produce brown flocs when added to water.

Activated Silica

Near-neutralised sodium silicate is used at a few plants, either as a floc aid, or in conjunction with lime. The neutralisation is done on site usually with sulphuric, or hydrochloric acids.

Quick Lime and Slaked (hydrated) Lime

Limestone, CaCO_3 , when heated in a kiln to drive off carbon dioxide, gives rise to quick lime, CaO , which in the form of pebbles or lumps, combines with water to produce slaked lime, Ca(OH)_2 , in the course of which it swells and disintegrates into a fine powder. The resultant slaked lime is sometimes used directly or, when dried and cleaned up by blowing a current of air through it to remove incorporated sand, may be dosed as a powder.

Slaked lime has two main uses: Firstly, as an alkali for pH control in conjunction with a flocculant and secondly as a means of rendering soft waters non-aggressive to cement and concrete.

It may be fed directly into the water stream from some form of powder feeder placed directly above or near to the point of addition. Less desirably, addition can be into an intermediate solution tank but because of the low solubility there is risk of settlement before it reaches the final dosing point.

Sodium Carbonate (Soda Ash or Washing Soda)

Sodium carbonate is a very soluble alkali that is sometimes used at smaller treatment plants and, usually, at municipal swimming pools for pH control.

Sodium Hydroxide (Caustic Soda)

Sodium hydroxide is an alkali that is seldom used in water treatment, because of its cost and the hazard associated with its use.

OPERATION AND CONTROL

Jar Tests

The procedure for jar tests is similar for clay and silica bearing waters and brown waters and both are described together.

Although much of what has been dealt with so far, will have been decided at the design stage of the plant, jar tests are the tool of supervisors and operators which, properly used, will tell them what is going on with their water at any given time. Waters are variable in quality and expert guidance is seldom available when most needed.

There are two kinds of jar tests.

The first is to take a beaker (600 - 1000 ml) full of the dosed water that is being treated in the plant, at regular intervals, say once or twice a shift - preferably at the start and in the middle of the shift. Stir it for a given period, say 10 - 20 minutes, at a given rate, say 20 - 30 rpm, and observe the clarity and settling rate. If a turbidimeter is available, measure the turbidity of a sample of the settled water sucked out of the bulk of the liquid after, say, 15 min of settlement.

With brown waters, if a UV spectrophotometer or colorimeter is available, filter some of the same sample, and measure the absorbance. For a colorimeter use the lowest available wavelength, otherwise 254 or 300 nm. (Spectrophotometers usually measure down to 200 nm or lower while colorimeters as a rule only go down to around 400 nm)

The water between the floc particles should be clear and sparkling. Compare the results with the previous ones.

The main requirements are a paddle stirrer, (desirably) a turbidimeter and for brown waters, very desirably, a spectrophotometer or less desirably a colorimeter. The water volume, stirring rate and period and the settling period should be standardised.

The second is to do a jar test with a range of doses and/or pH values. This test is usually only done occasionally, when the water quality has changed.

Equipment For Jar Tests

A multiple-bladed (4 to 6) paddle stirrer, variable speed, preferably Phipps and Bird, but otherwise any other make or design. The main requirement is that the blades are between 30 x10 mm and 75 x 25 mm in size. The speed should be variable from 10 to 300 rpm. In addition, a laboratory stirrer is needed for rapid mixing.

If pH is important, as in the case of brown waters, a pH meter should be provided. Buffer solutions are also required and the meter should be adjusted at the start of each test session.

Beakers: size 600 - 1000 ml.

Graduated pipettes: 2, 5, 10 and 25 ml.

Measuring cylinder: 500 or 1000 ml.

Turbidimeter.

Figure B1.4 shows a picture of a jar test apparatus.

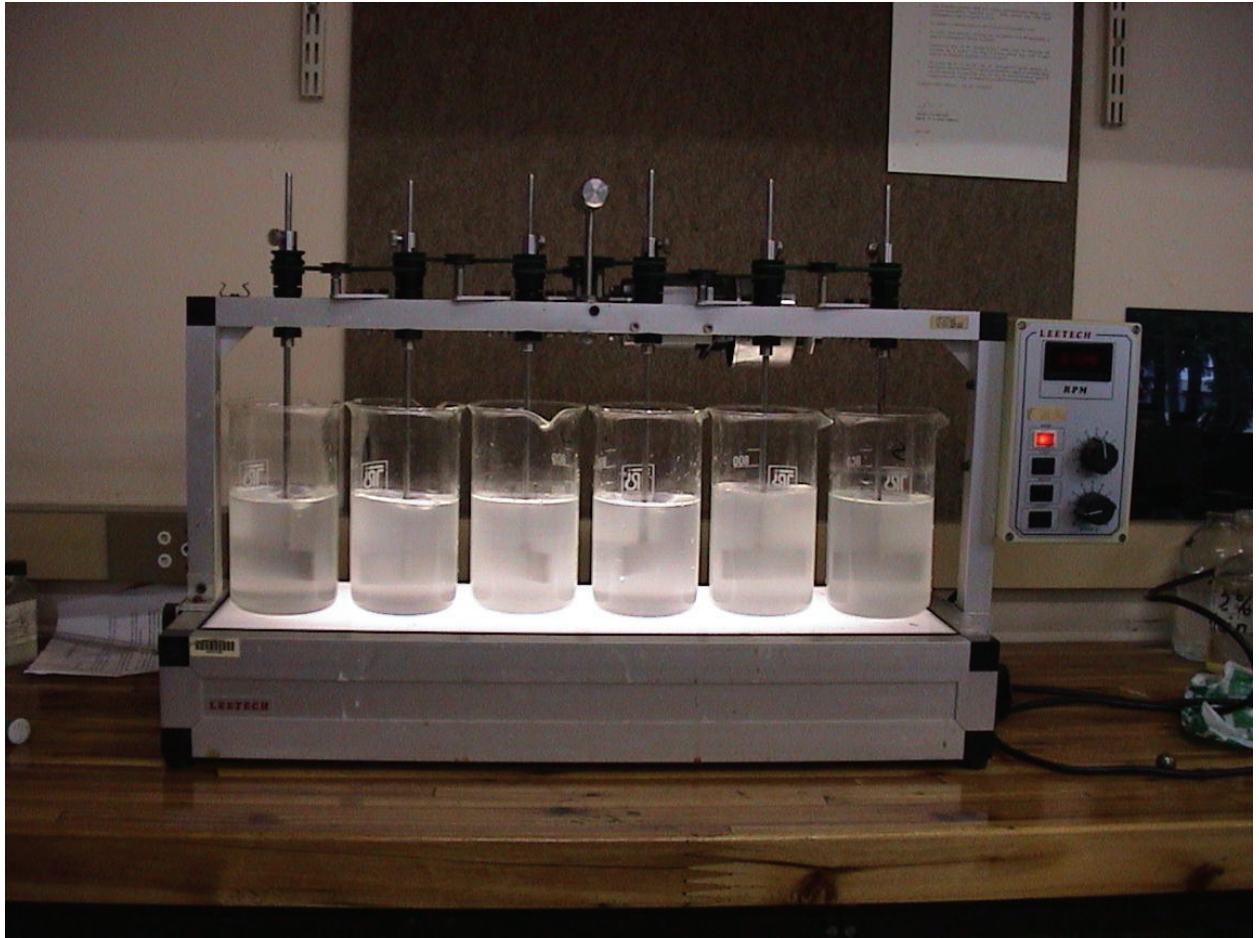

Figure B1.4: Picture of a jar test apparatus.

Chemicals For Jar Tests

Coagulant: the concentration should be such that convenient small volumes, say 1 to 25 ml, are required for dosing. It is important that a concentration is chosen such that, for example, 1 ml corresponds to a dose of, say 1, 2, 5 or 10 mg/l. If the solution becomes cloudy on standing add a drop or two of acid (of say 1 mol/l).

Alkali: Usually lime is used. Prepare a saturated solution (2 g/l) in distilled water, a day before use and allow to settle. Do not stir before use. This can be used for several months if well stoppered. If sodium carbonate is required, then dissolve 106 g in a litre of distilled water (1 mol/l) and dilute so that not more than 5 % is required for neutralisation.

Procedure for Jar Tests

Measure out 500 ml portions of the water to be tested in a measuring cylinder and pour into each beaker.

Take one beaker at a time and place on the laboratory stirrer. Mix at a rapid rate - standardise this. Measure out the coagulant and, if required, an alkali. These steps should be done fairly quickly.

Place the beaker on the paddle stirrer, and stir at a fixed rate, somewhere in the range 20 to 30 rpm, depending on the size of the paddles - the floc should be kept in suspension.

Then treat the next beaker of water etc.

After 15 to 20 minutes stirring (use the same time for each beaker) remove and allow to settle for 30 minutes. Then measure the turbidity and, if appropriate, UV absorbance (after filtration).

A range of doses or pH values should be covered in a batch, which can be done one after the other.

Plot the results and choose a suitable dose/pH.

PLANT EQUIPMENT

Rapid mixing

Various types of rapid mixers are available:

- * **Dosing Weir:** This is usually a channel ending with a weir. It may be followed by further weirs. The dose is applied at, or just after, the top of the weir.
- * **Hydraulic Jump:** A channel with a smooth, rapid fall in level leading to more gradual but partial recovery in height. The chemical is added at, or just after, the top of the jump.
- * **High-speed Stirrer:** The water enters over a weir at one corner of a rectangular basin, where the dose of chemical is applied, and leaves at the opposite bottom corner. There is a high-speed mixer in the centre,
- * **Ring Mixers in a pipe:** Narrowed throat with injections of chemical around the periphery.
- * **Hydraulic Flash Mixer**

Figure B1.5 shows an example of hydraulic mixing.



Figure B1.5: Hydraulic rapid mixing at Vereniging works of Rand Water.

Flocculators

Three basic types of flocculators are to be found,

- * Completely stirred reactors. The dosed water is fed in at the top corner of a rectangular tank with a stirrer in the centre and goes out of the opposite bottom corner. The stirrer may be omitted.
- * Baffled channels. The dosed water passes down a channel with baffles at intervals down it.
- * Spiral flocculator with gradual tapering energy dissipation.

Figure B1.6 shows a spiral flocculator at the Vereniging works of Rand Water.



Figure B1.6: Spiral flocculator

Coagulant Dosage Control

Controls can vary from hands-on mechanical affairs to knobs on panels.

Coagulants are fed as solutions and the dosing equipment ranges from sophisticated mass flow meters to piston and diaphragm metering pumps to various simple constant head devices.

Metering pumps consist of pistons or diaphragms which have an intermittent pumping action coupled with a set of non-return valves to give a nearly continuous flow. The intermittent flow is the main disadvantage of these pumps.

One type of constant head device consists of a floating needle valve controlling the gravity fed flow into a small tank with another tapered needle valve at the outlet, which is at the bottom of the tank and can be screwed in or out to control the feed rate.

Another type consists of a float with a tube down the centre, which has a set of holes in it at regular intervals and which can be raised or lowered below the level of solution to give a constant head. The tube down which the solution runs then leaves the tank near the bottom through a watertight connection.

There are no doubt other ingenious methods of arranging to get a constant head.

Although the design of the dosing point/s is usually fixed there is often some flexibility in the dosing arrangement. Thus, the method of addition of the chemical to the water can range from a solid stream to a spray. The best arrangement is probably somewhere in-between.

pH Control

One usually controls the pH by adding alkali. For example after addition of coagulant (acidic) one adds lime (alkaline), until the pH is where you want it to be. (Of course the order of addition will depend on the results of full-scale jar tests.)

You will find that the effect of adding equal increments of lime varies, depending where you are on the pH scale. At first as you add lime the response is slight but as the pH nears the range of interest it increases considerably.

This makes automatic control somewhat difficult as it relies on having equal responses for equal increments; however it can be done.

Lime Feeders

Lime feeders usually consist of a bin with sloping sides near the bottom. There will be either a revolving plate with a scraper or a revolving screw feeder immediately below the bin.

The lime will either drop into the main water stream or into a smaller stream, which may or may not be stirred. The latter is less desirable than the former because of potential blockages.

There is usually vibrator somewhere on the dosing equipment, to keep the lime from arching or caking.

Sodium Carbonate Feeders

Sodium carbonate is fed as a solution, so the equipment is similar to that used for coagulant solutions.

SCHEDULES

Once an hour, or when there is a flow change, inspect your floc.

Every two hours or four hours do a jar test.

Every four hours, or when there is a flow change, check your doses,

WHAT CAN GO WRONG AND WHAT TO DO

Blockages

There are a number of places in both the liquid and the solid feed lines where blockages can occur. In the liquid line there are things such as rags, sticks, small stones, etc which shouldn't be there, but which sometimes are.

With a solid feeder the same type of things are not so easy to notice.

There may also be problems with arching, caused by the creation of an arch inside the lime feeders. Although feeders with vibrators minimise these effects, they still happen. They can also be spotted by changes in pH recordings, where these are used.

These effects are worse in small plants, and are best dealt with by keeping an eye on the condition of your floc.

You lose your floc

Check your dose/s. Usually there will be a blockage of one sort or another somewhere or other. Experience will usually tell where to start looking, but otherwise start at the dosing device and follow it down to the point of addition to the water.

CHAPTER B2: SEDIMENTATION AND FLOTATION

Frik Schutte

INTRODUCTION

Floc aggregates that are formed during coagulation-flocculation in conventional water treatment are typically removed from the water by means of sedimentation (or flotation) and sand filtration. Sedimentation is the process in which the flocs are allowed to settle from the water and collect at the bottom of the sedimentation tank as sludge from where the sludge is regularly removed. The clean water leaves the sedimentation tank through collection troughs located at the end of horizontal tanks or the top of vertical sedimentation tanks. Floc aggregates can also be removed by flotation and sand filtration. Flotation is the process in which the flocs attach to minute air bubbles introduced into the water and rise to the surface from where the float containing the floc is regularly removed. Clean water is abstracted from the bottom of the flotation unit.

The terms **sedimentation** and **settling** are used interchangeably. A sedimentation tank may also be referred to as a sedimentation basin or settling tank. Sedimentation tanks may be of different shapes and can be functioning as settling tank only, or it can also incorporate flocculation and sludge compression. Different proprietary designs are available, but the basic functioning of all types is similar.

PROCESS DESCRIPTION

Sedimentation or settling is the simple process in which particles that are heavier than water settle to the bottom of a container in which the suspension is held, or through which the suspension flows. On the basis of the concentration of particles and the tendency of particles to interact, four types of settling behaviour can be distinguished: discrete particle settling, flocculent settling, hindered (also called zone settling) and compression settling. These types of settling phenomena are described in Table B2.1.

Often more than one type of settling occur at the same time during the settling process and it is not uncommon to have all four occurring simultaneously as shown schematically in Figure 1.

Table B2.1: Types of settling behaviour in drinking water treatment.

Type of settling phenomena	Description
Discrete particle (Type 1)	Refers to the sedimentation of particles like fine sand or chemical floc of low solids concentration. Particles settle as individual entities and there is no significant interaction with neighbouring particles.
Flocculent (Type 2)	Refers to relative dilute suspensions of particles that coalesce, or flocculate during the sedimentation operation. By coalescing, the particles increase in mass and settle at a faster rate. This is typical for the settling of chemical floc.

Hindered, also called Zone settling (Type 3)	Refers to suspensions of intermediate concentration of chemical floc, in which inter-particle forces are sufficient to hinder the settling of neighbouring particles. The particles tend to remain in fixed position with respect to each other and the mass of particles settles as a unit. A solid-liquid interface develops at the top of the settling mass.
Compression (Type 4)	Refers to the settling in which the particles are of such concentration that a structure is formed and further settling can occur only by compression of the structure. Compression takes place from the weight of the particles, which are constantly being added to the structure by sedimentation from the supernatant liquid.

Effective sedimentation and removal of particles from water depends mainly on the effectiveness of the coagulation-flocculation process and on the proper design of the sedimentation tank. If coagulation (charge neutralisation and destabilisation) is not effective, the forces that keep particles apart will persist. If flocculation is not effective, the opportunity for collision between particles and floc growth will not be optimal and large floc aggregates that settle readily will not be formed. If coagulation-flocculation is effective but the design of the sedimentation tank is such that flocs deteriorate due to poor inlet design, or flocs cannot settle due to too high up-flow velocity or short-circuiting, the effluent water will still have a high turbidity.

EQUIPMENT

Different designs exist for sedimentation tanks. The most common designs are rectangular horizontal flow tanks in which the water enters one side and leaves at the other end, and circular tanks with flat or cone-shaped bottoms with water entering the tank at a central distribution section and leaving at collection troughs at the circumference of the tank.

All sedimentation tanks can be divided into four zones, each with a specific function. These are the inlet zone, settling zone, outlet zone, and the zone for sludge storage. A schematic diagram of the zones is given in Figure B2.1.

The purpose of the *inlet zone* is to distribute the flow and suspended floc particles evenly across the cross section of the settling zone. It normally consists of a series of pipes and baffles through which the flow is distributed into the settling zone. The water velocity is reduced as it enters the settling zone. Proper inlet zone design is important to prevent deterioration in floc structure and to achieve good solids removal efficiency. The *settling zone* is the largest part of the sedimentation tank and settling takes place as the water flows at reduced velocity through a large flow area (width times depth). The low velocity allows floc particles to settle into the sludge zone and be removed from the water leaving the tank.

The settling velocity and overflow rate are two important parameters that determine solids removal efficiency in the settling zone. The rate at which a particle settles is the particle settling velocity, while the velocity of the water rising in the settling zone is the overflow rate. Obviously if a particle is to be removed in the settling zone the settling velocity must be higher than the water rise velocity or the overflow rate. The overflow rate (up-flow rate) or surface-loading rate is an important design parameter

and has the units of $\text{m}^3/\text{m}^2.\text{d}$ or m/d (flow of water m^3/d being applied per m^2 of surface area), or $\text{m}^3/\text{m}^2.\text{h}$ if flow is in m^3/h . The overflow rate is relatively low for horizontal flow tanks, in the range of 1-2 m/h and higher for vertical tanks, in the range of 3-5 m/h . Much higher rates of 15 m/h and higher have been mentioned in the literature.

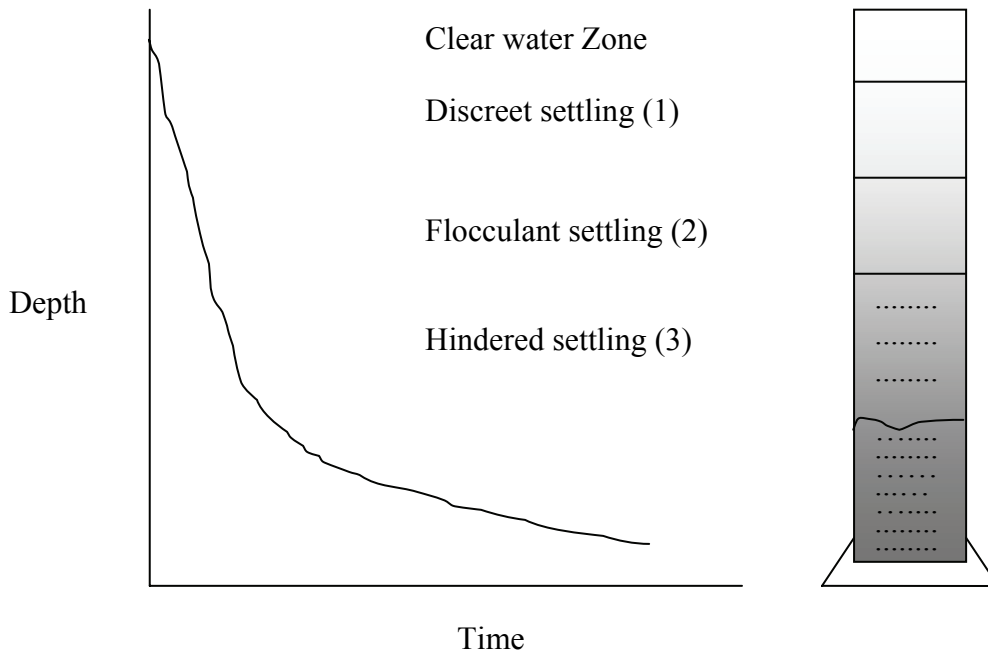

Figure B2.1 Illustration of different settling types

The *outlet zone* provides a large area for the water to leave the sedimentation tank before flowing into a pipe or canal to transport the water to the sand filters. The outlet zone is designed so that settled water can be removed from the tank without entraining any floc particles that have settled. The objective of the large area is to minimise the flow velocity and thereby prevent scouring or lifting of the settled floc. The large outlet area is obtained by means of a series of weirs or troughs into which the water decants or overflows.

The configuration and depth of the *sludge storage zone* depends on the quantity of sludge removed from the water and the method and frequency of cleaning. Mechanically cleaned settling tanks normally have a bottom scraper that scrapes the sludge continuously to a hopper from where the sludge is pumped out. Figure B2.2 portrays the different zones in horizontal sedimentation tank.

A specific design of sedimentation tank that allows flocculation to take place in the unit is the so-called sludge blanket (or floc blanket clarifier). A typical unit consists of a cylindrical upper section with a concentric inlet and flat or hopper-shaped base. Water that has been coagulated is fed downward through the inlet into the base of the tank. The upward flow through the settling section facilitates contact with particles in

that zone and allows flocculation to occur so that large floc particles remain in suspension in the tank. Particles in suspension accumulate slowly at first but increase because of enhanced flocculation. This continues to a maximum accumulation rate limited by the upflow velocity of the water and particle characteristics. At this rate a floc blanket has been established in the tank.

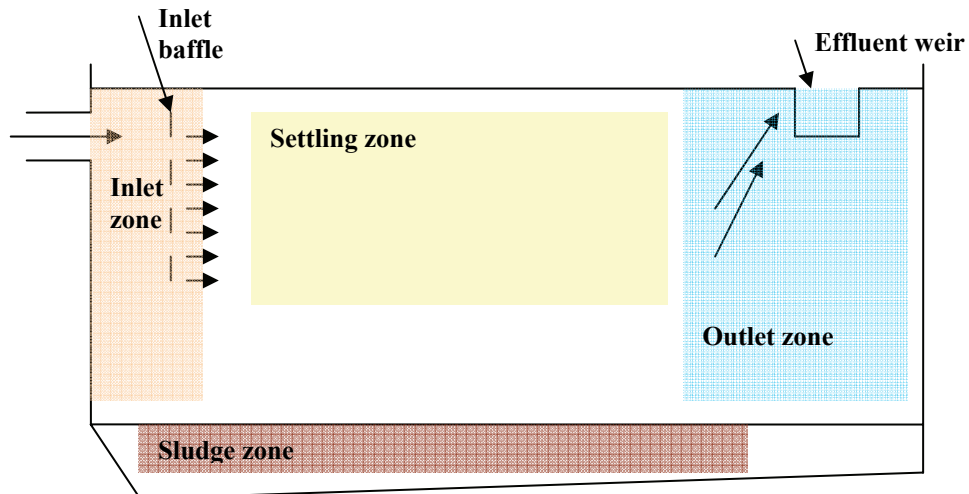

Figure B2.2 Settling zones in a horizontal sedimentation tank

The floc-blanket surface level is controlled by removing solids from the blanket so as to keep a zone of clear water between the surface of the floc blanket and the troughs through which the clear water leaves the clarifier.

OPERATIONAL ASPECTS

A number of factors affect the performance of sedimentation tanks. These factors fall in two categories, i.e. hydraulic factors and particle characteristics. Hydraulic aspects include the flow-through rate, residence time in the tank, the size and shape of the tank, the inlet and outlet flow arrangements, possible short-circuiting, sludge removal mechanism and removal frequency. Floc particle characteristics include size, nature, density and strength of the floc.

Sedimentation is suitable for removal of flocs such as silt and clay particles that are relatively heavy and settle readily. However, flocs formed by flocculation of algae or organic matter are relatively light and do not settle readily. Flotation is a much more effective process for removal of such light flocs. Sedimentation and flotation perform the same function, with sedimentation being used normally when the raw water contains mainly silt or clay particles, while flotation is used when the raw water contains algae or other types of organic material.

Settling velocities

The function of a settling tank is to remove by gravity particles that are denser than water. The rate at which a particle will settle (v_p) under quiescent conditions depends on:

- The concentration of particles
- The size and shape of the particles. Large particles settle faster than small particles and smooth spherical particles faster than flaky ones such as agglomerates.
- The density of the particle relative to the density of water.
- The viscosity of the liquid. The higher the viscosity, the lower the settling rate. As the viscosity of a liquid is also a function of temperature, the cooler the liquid, the higher the viscosity and thus the lower the settling rate.

Surface overflow rate

One of the main criteria for the design and operation of a settling tank is the surface overflow rate. The surface overflow rate gives the upflow velocity of the water for a given flow of water (Q) and water surface area (A) of the settling tank and can be presented mathematically:

$$V_s = Q/A$$

Where: V_s = upflow velocity of water in the settling tanks m/h

Q = inflow rate, m³/h

A = water surface area of settling tank, m²

All particles with a settling rate (V_p) > surface overflow rate (V_s), will settle and be removed from the influent stream.

Hydraulic residence time

The hydraulic residence time indicates how much time the water spends in the tank. The hydraulic residence time is calculated as follows:

$$\tau = V/Q$$

Where: τ = hydraulic residence time, h

V = volume of settling tank, m³

Q = inflow rate, m³/h

Although the hydraulic residence time theoretically does not play a role in the efficiency of the settling tank, larger settling tanks with longer hydraulic residence times have more storage space for sludge and generally give a higher sludge concentration.

Horizontal flow tanks

With rectangular horizontal-flow tanks the water enters the tank at the inlet section and the settled water leaves the tank through outlet troughs at the outlet end. The inlet flow arrangement must provide a flow distribution that maximises the opportunity for particles to settle. If flocculation has been carried out to maximise floc particle size, then the flow at the inlet should not disrupt or break up the flocs. This requires minimising the head loss between the distribution channel and the main body of the tank. However, a certain amount of head loss is necessary to achieve flow distribution.

The principal differences between tanks relate to inlet and outlet arrangements; length, width and depth ratios and the method of sludge removal. For horizontal-flow tanks with a small length-width ratio the end effects dominate efficiency. Poor flow distribution may produce currents or high flow velocities near the bottom of a tank. This may cause scour, or re-suspension of particles from the layer of settled sludge. Scour may cause transportation of solids along the bottom of the tank to the outlet end. An adequate tank depth of not less than 2,5m limits scour.

The frequency of sludge removal depends upon the rate of sludge accumulation. This is estimated by mass balance calculations to determine the removal frequency. Sometimes, the decomposition of organic matter in the sludge necessitates more frequent sludge removal. Decomposition may produce gas bubbles that disturb the settled sludge and cause deterioration in settled water turbidity.

Frequent sludge removal is best carried out with mechanical sludge scrapers that sweep the sludge to a hopper at the inlet end of the tank. Frequent removal results in easy maintenance of tank volumetric efficiency, and better output efficiency with continuous operation. In larger tanks sludge may be removed continuously by means of sludge pumps located on a travelling bridge.

Figure B2.3 shows a large horizontal sedimentation tank at the Vereniging works of Rand Water.



Figure B2.3: Horizontal sedimentation tank

Factors influencing sedimentation efficiency

Surface loading of a sedimentation tank is a primary factor that affects sedimentation efficiency. It is expressed as the flow rate per unit of surface area of that part of the tank in which settling occurs. Settled-water quality normally deteriorates when surface loading is increased. Changes in flow rate may affect flocculation performance as well as sedimentation efficiency. High surface loading rates are desirable from a cost point of view, but the efficiency will then be more sensitive to major variations in surface loading, water quality and environment conditions.

For all types of settlers, flow velocities in approach channels or pipe work that are low enough to allow premature settlement must be avoided. Conversely, flows high enough to disrupt and break up floc aggregates must be avoided.

Baffles are useful in horizontal-flow tanks at the inlet and outlet to assist flow distribution, longitudinally to increase length-width ratio, and as vanes to assist changes in horizontal-flow direction.

Particulate and water quality

Sedimentation efficiency may vary with seasonal changes in temperature, alkalinity and similar parameters, as well as with changes in the nature of colour and turbidity being coagulated.

Temperature affects efficiency by influencing the rate of chemical reactions, solubility, the viscosity of water and hence particle-settling velocities and possibly density currents. Changes in alkalinity, colour, turbidity and orthophosphate concentration for eutrophic waters affect coagulation reactions and the properties and rate of settling of resulting floc particles.

Coagulation. Particle-settling velocity is affected by various particle characteristics, principally size, shape and density. The choice of coagulant, dosage and flocculation conditions affect floc particle characteristics. Optimum chemical doses for sedimentation can be determined by jar tests.

The efficiency of horizontal flow sedimentation tanks is dependent on proper flocculation of coagulated water. The efficiency of sludge blanket units on the other hand, depends on effective mixing of chemicals with water for flocculation to take place in the solids contact region of the tank. Mixing assists with chemical dispersion, flocculation, solids re-suspension and flow distribution. Because these can conflict with each other, mixing rates should be adjusted when changes are made to the flow-through rate.

Flocculent aids such as polyelectrolytes improve sedimentation efficiency by increasing floc strength and size. Jar tests can be used to select suitable polyelectrolytes and determine a trial dosing range. Optimal doses must however be carefully determined by full-scale plant tests. An excessive dose producing good settled water may be detrimental to filters.

Wind and density currents

Wind can induce undesirable circulation in horizontal-flow tanks. Wind effects should be minimised by constructing tanks to align with prevailing winds. Strong winds can disrupt floc-blanket stability. This can be counteracted by covering tanks with roofs, constructing windbreaks around tanks, or installing fully submerged baffles in the supernatant water.

High solar radiation can cause diurnal changes in water temperature and density. Rapid density changes because of temperature, solids concentration, or salinity can induce density currents that can cause short-circuiting and reduced efficiency in horizontal tanks.

Wastes produced

The sludge removed from sedimentation tanks is the major waste produced at a water treatment plant. The sludge consists of the suspended and colloidal material removed from the water together with the precipitate formed by the coagulant and flocculant. The nature of the sludge is largely determined by the coagulant used, for example the nature of lime sludge differs largely from the nature of sludge produced from ferric chloride as coagulant.

The sludge is withdrawn from the sedimentation tank and may then be thickened before disposal or may be disposed of directly. The concentration of sludge produced determines the actual volume to be disposed of. Alum sludge normally has a low solids concentration of less than 1% m/v while lime sludge can have a solids concentration of up to 4 or 5% m/v.

Sludge can be thickened to reduce the volume to be disposed of. This is normally done in circular thickening tanks that produce thickened alum sludge of about 3% m/v solids concentration and lime sludge of 20-22 % m/v solids in the under flow.

Sludge is normally disposed of in sludge lagoons at smaller treatment works. A sludge lagoon is simply a large hole with sufficient capacity to store sludge for a predetermined period of time. The floor of the lagoon must be impermeable to prevent pollution of ground water. Provision must be made for a second lagoon to remove sludge when the capacity of the first lagoon has been reached. The sludge can then be disposed of in a landfill site.

Dewatered sludge may also be disposed of on landfill sites. Dewatering is accomplished on sludge drying beds or by means of dewatering devices such as belt presses.

Operational considerations

Since no chemical addition or chemical reactions take place in a sedimentation tank, a basic level of expertise is required for operation. The main operational asks are:

- Ensuring an even inflow and distribution of flocculated water into the tank. The distribution of flocculated water in the sedimentation tank is mainly determined by design. The operator must therefore observe flows and the nature of flocs. If it is evident that flow distribution problems exist, the operator must investigate possible problems such as blockages in channels or inlet pipes and clean if necessary.
- Ensure that the scraping mechanisms and moving bridge function properly. Maintenance must be carried out according to schedule to ensure proper functioning. Regular visual inspections are also necessary to detect possible mechanical problems. If mechanical problems occur, the equipment must be stopped and maintenance staff called in.
- Sludge must be pumped regularly from the tank according to operating instructions. If sludge is left too long in the tank, it may become too thick and cause pump problems. Alternatively settled sludge may be entrained and cause a deterioration in settled water quality. If sludge is pumped too frequently, the sludge may become very thin, resulting in high water losses and rapidly filling of sludge dams or lagoons.
- The sides and overflow weirs of the sedimentation tanks must be kept free from algal and other growths by regular brushing and cleaning. Algal growths may cause taste and odour problems and also create a poor impression of the operation and control.
- The turbidity of the overflow from each tank must be determined on a regular basis. If the turbidity exceeds set values, the cause for poor performance must be determined and corrective action taken. Possible causes include an increase in inflow to the sedimentation tank as a result of increased production or due to problems with flow distribution between tanks. Other possible causes include too low pumping frequency of sludge or wind or density currents.
- In case of poor performance, check inflow volume, calculate upflow velocity, check inflow distribution, check coagulation, check flocculation and correct where necessary

FLOTATION

Flotation involves the formation of small air bubbles in water that has been coagulated. The bubbles attach to the flocs causing them to rise to the surface where they are collected as a froth that is removed from the top of the flotation unit.

Air is dissolved under pressure in a small amount of water in a device called a saturator. This water that is saturated with dissolved air is added to the main stream of water that is to be treated. When the pressure is released after the saturated water is mixed with the water to be treated, the dissolved air comes out of solution in the form of very fine bubbles.

Both sedimentation and flotation remove the bulk of the flocs from the water. However, most of the time a small amount of (broken) flocs or non-flocculated colloidal material remains in the water. This material has to be removed to ensure a low enough turbidity in the water. A sufficiently low turbidity level is required for effective disinfection of the water and to remove all traces of murkiness from the water. Removal of turbidity to low levels is achieved by means of sand filtration.

Dissolved air flotation (DAF) systems

In dissolved air flotation systems, air is dissolved in the water under a pressure of several atmospheres, followed by release of the pressure to the atmospheric level. In small pressure systems, the entire flow may be pressurised by means of a pump to 275 to 350 kPa. The entire flow is held in a retention tank under pressure for several minutes to allow time for the air to dissolve. It is then admitted through a pressure-reducing valve to the flotation tank where air comes out of solution in minute bubbles throughout the entire volume of water.

In larger units a portion of the water (7-15%) is recycled, pressurised and saturated with air. The recycled flow is mixed with the un-pressurised main stream just before admission to the flotation tanks.

The combination of flotation and filtration in one unit has developed over the last number of years. The main advantage of this arrangement is a very compact treatment plant that is very useful in package treatment plants. A rapid gravity sand filter is incorporated in the bottom section of the flotation unit. Limitations of this type of plant include the fact that the flotation rate is limited by the filtration rate, and furthermore the flotation unit has to be stopped occasionally to allow backwashing of the filter.

Flotation elements

The following elements are involved in flotation:

- Chemical pre-treatment in the form of coagulation-flocculation is normally required for effective flotation. A large number of destabilised relatively small floc particles must be formed during flocculation that can readily be floated to the surface (sedimentation in contrast, require large floc particles that can settle readily)
- Flotation is more complex than sedimentation since there are three phases involved, i.e. solid, liquid and gas. The solid flocculated particles come in contact with a large number air bubbles in the reaction zone of the flocculator. In this zone stable particle-bubble agglomerates must be formed that can be floated to the surface. Mechanisms involved in formation of floc-bubble agglomerates include adhesion of bubbles to the floc surface, entrapment of bubbles in preformed floc, adsorption of bubbles onto floc, growth of bubbles on nuclei within flocs.
- A very large amount of micro air bubbles is required for flotation. Bubble production comprises the abstraction and pumping of treated water (recycle) through an air saturator system and injection of the super-saturated water into the reaction zone. This is achieved by suddenly releasing the pressure of the recycle flow from around 350 –500 Kpa down to atmospheric pressure. About 10 % of the

clarified water is recycled into the air saturation system. The water is pumped through an injection device such as an eductor that introduces high-pressure air into the system. Saturated water flows to the dispersion system where the pressure is released and the micro bubbles formed.

- Bubble size is very important. Too large bubbles will rise rapidly and result in poor performance. Too small bubble will add to size and cost of flotation tank. Bubbles should be in around 50 μm , in the range of 10 – 100 μm .
- Flocculated water must be introduced uniformly across the end of the tank near the bottom into the dispersion zone.
- The float of bubbles and floc collects at the surface of the tank where it forms a stable and continuously thickening float. The float must be removed regularly either by mechanical skimming or hydraulic removal.

Combined flotation/filtration

For potable water treatment purposes, whether flotation or sedimentation is used, the water is inevitably filtered as a final polishing step. For clarification purposes, the flotation and filter functions are sometimes combined into a single process unit, with flotation carried out on top of the filter bed. The process is commonly known in South Africa as the DAFF process (dissolved air flotation filtration) and as Flofilter in Europe and as Sandfloat in the USA. There is no difference between settled and floated water as far as its effect on the subsequent filtration step is concerned.

Operational considerations

1. Coagulation-flocculation must be operated to produce well-flocculated particles with rather larger numbers of smaller floc particles compared to the large floc required for sedimentation.
2. Flow and pressure must be controlled in accordance with operating instructions. There are three external connections to any saturator, i.e. the recycle inlet, the recycle outlet and the air inlet. It is also required that an air cushion be maintained inside the saturator. The water level inside the saturator must therefore be controlled. This can be done by controlling the recycle inlet and outlet to maintain a constant flow rate through the saturator. The water level is then controlled between two set limits by closing the air inlet valve when the minimum level is reached and opening it when the maximum is reached.
3. Removal of floated solids can be done mechanically or hydraulically. Mechanical removal by means of chain-and-flight skimmers or other types requires maintenance of the mechanical equipment and visual inspection to ensure effective operation. Float can also be removed hydraulically by flooding. This is done by partial closure of the effluent gate or by raising an effluent weir. The increase in water level lifts the surface above a weir that discharges to the sludge drain. When most of the float is removed the gate reopens or the weir is dropped and operation returns to float mode.

CHAPTER B3: SAND FILTRATION

Johannes Haarhoff

INTRODUCTION

Why filtration is necessary

Some form of filtration will always be found at a water treatment plant. While coagulation, flocculation, sedimentation and flotation play important roles and will remove the bulk of the particles from the raw water, they alone will not meet the strict quality standards that are required of drinking water. Filtration is the only process that is capable of removing very small particles down to the level required.

For many years, filtration had been viewed as a simple aesthetic *polishing* step to complete a chain of processes, starting with chemical dosing and ending with filtration. However, in the past decade or more, there has been a renewed interest in filtration, as it turned out that the process is the *only* one that can be completely relied on to remove a number of newly discovered health hazards, namely the protozoan cysts and oocysts common to most raw water sources in the world, also in South Africa. Higher standards for filtration performance have thus been globally adopted and water supply utilities are taking a new, critical look at their filtration facilities.

The anatomy of a filter

The heart of a filter is the *filter media*, consisting of a layer of uniformly sized media grains. The media is supported on either one or two thin layers of *supporting gravel* and *grit*, or the media rests directly on a suspended *filter floor*. Within the filter floor are numerous *filter nozzles*, evenly spaced at a density of between 20 and 50 nozzles per square metre. The top of the nozzles, or *nozzle domes*, protrude above the level of the filter floor, while the bottoms of the nozzles, or *nozzle stems*, go through the filter floor into the *under-floor plenum*. When gravel supporting layers are used, the *slots* in the nozzle domes are about 3mm wide, as the gravel layers prevent the fine filter media from reaching the nozzle domes. When there are no supporting layers and the filter media rests directly on the nozzle domes, the dome slots are less than 0,5 mm wide to prevent the media from entering the under-floor plenum. The under-floor plenum is formed either by suspending the filter floor, usually in the form of prefabricated panels, above the *structural floor* below (the *false floor* system), or by a series of closely spaced pipes which are fixed onto the structural floor and encased in concrete (the *pipe lateral* system).

All of the above are contained within a *filter box*. Figure B3.1 shows a schematic representation of a sand filter. Seen from the top of the filter box, a *backwash trough* and either one or two *filter bays* can be discerned. It is useful to know the total area of the filter bays in a filter box, as the *filtration rate* can be calculated by dividing the flow rate per filter by the media area. Also, the *backwash rate* can also be calculated by closely monitoring the rise rate of the backwash water in the filter bay before the water spills into the backwash trough. Each filter box has to have five connections to the outside world:

- An *unfiltered water inlet* into the headspace above the media for the flocculated (and usually settled) water to be filtered.
- A *filtrate outlet* from the under-floor plenum for the filtrate, which normally passes into an *outlet box* fitted with an *overflow weir*.
- A *clean backwash water inlet* into the under-floor plenum.

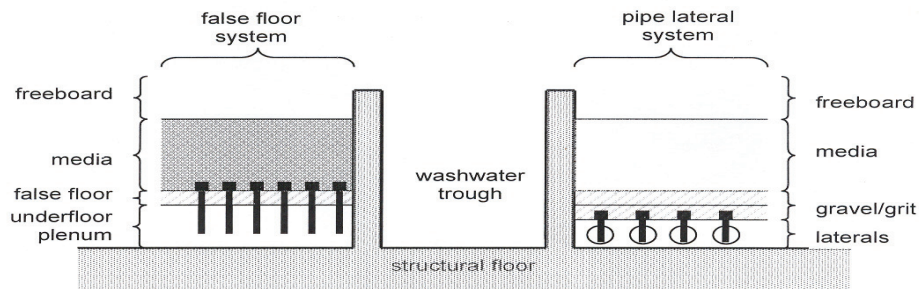

Figure B3.1: Schematic representation of a sand filter.

- An *air inlet* into the under-floor plenum.
- A *dirty backwash water outlet* from the filter backwash trough.

These connections of the different filters are connected with *pipe manifolds* or *canals* and controlled by *valves*. The backwash pumps, the air compressors and the multitude of valves are all controlled by a *filtration control system* and a *backwash control system*. The filtration control system has to split the total incoming flow evenly amongst all the filters and compensate for the fact that all the filters could be clogged to different degrees, while the backwash control system has to reverse the flow direction by opening and closing the appropriate valves and starting/stopping the air compressor and backwash pump(s) for the desired periods. The filtration control system is always automated, either by hydraulic means or, more recently, by electronic means. The backwash control system can range from a simple system where human operators open/close valves and start/stop pumps and compressors, up to a sophisticated electronic control system where everything is automatically triggered and controlled by computer.

A typical filter run

Unfortunately, very little of the internal working of a filter can be observed during operation. The internal working has to be inferred from two external observations. Firstly, a gradual increase in head loss can be observed as progressively more energy is required to force the water through the bed as its pores are steadily clogged – a process which takes about 24 to 48 hours to get from a clean filter to a filter that needs to be backwashed. Secondly, a rather complex pattern is observed in the filtered water turbidity, shown below.

Initially, turbidity removal is not good as the filter goes through a *ripening* stage. Good quality water is produced during the next “steady state” removal stage. Eventually the breakthrough stage is reached as the bed reaches the limit to its capacity to remove particles from water.

How filtration works

Filtration is best understood if the process is visualised at a micro-level where a single particle is followed through a media bed. Such a typical particle may be imagined to be about 20 μm in diameter, the size where individual particles within water become visible to the human eye. The media grains, typically, will have a diameter of about 1 mm. On a linear scale, a media grain is thus about 50 times larger than a particle; the same ratio that differentiates a grain of rice from a soccer ball.

The flow conditions within the bed are not as quiescent as one would imagine. Typically, sand filters may be designed for filtration rates of 8 m/h through a bed of 800 mm thick. Using a typical filter bed porosity of 50%, it means that a suspension travels through the entire filter bed in about three minutes. In these three minutes, there will be at least one directional change in the flow path for every grain passed, leading to a total of at least 800 directional changes. A particle, therefore, will be “bumped” about four to five times every second for a period of about three minutes – a very rough ride indeed!

How does a particle then manage to get arrested within a media bed? There are a number of ways in which it is pushed towards the media surface. Its own momentum or its tendency to settle under the influence of gravity are commonly accepted as the most general *transport mechanisms* for getting the particle closer to the media surface. Once the particle comes close to the media surface, it sticks onto the surface by virtue of some short-range *attachment forces*. If one can visualise a collection of small particles (or *specific deposit*) stuck onto the “wall” of a much larger media grain, it is easy to appreciate that the specific deposit will have a delicate structure. The attachment of a particle onto a media surface, therefore, does not complete the filtration process. The particle remains subject to a number of *detachment forces*, which are mainly due to hydrodynamic shear of the flowing water trying to drag the specific deposit along, or direct collisions with other particles coming from the suspension. These detachment forces become stronger as the filter run progresses. Not only does the specific deposit become thicker and more fragile, but the flow velocity and the associated shear forces increase due to the reduced interstitial pore space. This explains why most of the particle removal initially takes place in the top of the filter, and then gradually moves down through the bed until we observe the phenomenon of *particle* or *turbidity breakthrough* towards the end of a filter run, when the media bed cannot arrest the particles sufficiently anymore.

It is already possible to recognise the important factors that impinge on filtration performance:

- Smaller media grains will filter better, as the openings between the grains become smaller. In this way, the particles need to be transported over a shorter distance to reach the media surfaces. Also, there are more contact points amongst the media grains and it is known from photomicrographic evidence that the specific deposit tends to concentrate around the contact points.
- Larger particles will filter better due to a greater chance of getting stuck within the pores of the media.

- A higher filtration rate will lead to poorer particle retention, due to the faster and more turbulent movement of the particles within the bed and the higher shear rates exerted on the specific deposit.
- Sudden changes in flow rates will tend to disrupt and dislodge the specific deposit. The specific deposit is a delicate balance between attachment and detachment forces and a small surge in flow rate could strip away previously deposited particles.
- Colder water is more viscous and will filter less effectively. The detachment forces due to hydrodynamic shear will thus increase when the temperature drops.

How backwashing works

A filter run comes to its end when particle breakthrough is observed, usually after a day or more since the previous backwash. It now becomes necessary to reverse the process of filtration. In other words, the specific deposit now has to be stripped from the grain surfaces and removed from the bed. The normal backwash process, which pushes water through the bed from below at roughly three times the normal filtration rate, accomplishes both of these processes. The higher backwash rate firstly subjects the grains to hydraulic shear forces much larger than that encountered during filtration and the deposit is sloughed from the media grains. At the same time, the fragments of the specific deposit are flushed upward through the bed, across the top of the filter and deposited as dirty backwash water into the backwash trough.

The degree of backwash attained by water alone, as described here, is often not enough to properly backwash the media. It then becomes necessary to apply additional force to the media grains to release more of the specific deposit. A common way to achieve this is to bubble air through the bed; the so-called *air scour* process. As the individual bubbles travel through the bed, the grains have to continuously move to and fro to let the air bubbles pass. In this way, the grains rub onto another, which is a much more effective way to clean the grains (as it is more effective to clean your hands by scrubbing than by just rinsing). After a period of bubbling the air, backwash with water is, of course, still required to carry the fragments of the specific deposit out of the bed.

If a plant has only water available for backwashing, a very high backwash rate has to be used to attain the shear forces required for effective media cleaning. This is an option commonly used in the United States in the past, where backwash rates were selected to get as high as 50% bed expansion upon backwash. If air scour is provided for, as is usually the case in South Africa, then much lower backwash rates can be used, as the water then only serves to flush the dirt from the bed. In this case, beds are seldom expanded by more than 10%.

At many plants, air is applied first, followed by water. As the air starts to bubble through the bed, some of the interstitial water is driven from the bed, the bed compacts and the air starts to “channel” along fixed paths. This happens within a minute after starting the backwash and reduces the degree of rubbing amongst the media grains; an effect that is clearly not desired. For this reason, it serves little purpose to continue with air scour for more than two to three minutes. This led to the introduction of *simultaneous* air and water, which is also a common option found at South African treatment plants. The logic here is that a small but continuous supply

of water will prevent the bed from collapsing, thus maintaining the rubbing of the grains for as long as the backwash lasts.

The following factors affecting backwash efficiency can now be recognised:

- The backwash rate inevitably decrease with time, due to impeller wear of the backwash pumps, valves that do not close completely when they should and the partial blocking of nozzles, leading to reduced hydraulic shear, bed expansion and backwash efficiency.
- A damaged or partially blocked under-drain system will not distribute the washwater or the air evenly across the media bed, leading to uneven rates and poor backwash efficiency.
- Areas of clogged media will not be expanded or cleaned during the backwash cycle, reducing both the filtration and backwash efficiency.
- Colder water is more viscous and will expand the bed slightly more, leading to marginally better backwash efficiency.

How flow control works

Various ingenious ways have been devised to ensure an evenly distributed flow amongst all the filters. This is not a trivial problem, as the filtration control system has to keep pace with fluctuations in the incoming flow rate, as well as the fact that all the filters have a different specific deposit at any given time and thus offer varying degrees of resistance to flow. A full explanation of the different flow control strategies is not appropriate here, except to say that practically all systems in South Africa are designed as *constant-rate* systems, meaning that all filters should equally share the flow at any given time.

The flow control is either done with a weir inlet at the upstream end, or with a control valve downstream of the under-floor plenum. In either case, the efficiency of the filtration control system can be measured directly at the inlet weirs into the filter boxes or the outlet weirs in the outlet boxes. If all the weirs have exactly the same geometry (filters built under a single contract normally has identical dimensions) then it only remains to carefully measure the overflow depth at each weir at the same time. These depths should be very similar, normally within 10% of the average. If one filter would overflow much more or less than the average, it means that that filter runs at a much higher or lower rate than it is supposed to. These problems should be reported to the maintenance personnel at the plant.

In extreme cases, mostly observed at plants with downstream filtration control, the automatic control system is patently broken or deliberately disabled, as evidenced by floats that are removed, control piping or wiring that is disconnected, etc. Such systems will never work satisfactorily and should be reported immediately and the affected filters taken off-line.

It has become standard practice at some treatment plants to exploit the savings offered by cheaper off-peak electrical power during times of low water demand. Such plants are then operated for one or two shifts and shut down for the remainder of the day. However compelling the reasons for such an operational mode may be, it should be realised that optimal operation of a filtration plant is not possible under such

conditions. The specific deposit, after being left in the media with no flow for a few hours, simply cannot resist the detachment forces when the filters are brought on-line again and will break through.

Modern computer technology makes it possible to incorporate two relatively new options into the filtration control system. Many studies indicated that the filter ripening period (the first hour or so of a filtration run) is the most likely period for the breakthrough of protozoan cysts and oocysts. Both options have been developed to ensure more robust performance of filtration systems during this critical period. The first is the *filter-to-waste* option, where the filtrate produced during the first hour or so is not supplied to the consumer, but returned to the raw water source. Should any unwanted organism break through during this period, the safety of the public is not compromised. The second is the *slow-start* option, which will reduce the load on a filter in the first hour or so after being backwashed. The slower filtration rate will lead to more efficient filtration, thereby reducing the chances of the breakthrough of harmful organisms. Care should be taken to *slowly* increase the flow rate from the slow start to the normal filtration rate after the ripening period. If the filtration control system is already computerised, then the adoption of the slow-start principle should simply be a matter of some programming. Should a switch to filter-to-waste be contemplated, it must be realised that some hardware changes may be necessary in addition to re-programming.

Filter floor systems

The hydraulics of filter floors and filter nozzles are beyond the scope of this chapter and something which cannot be altered by operation anyway. Keeping a filter floor system in good health, however, is very much the task and responsibility of the operating personnel. The following have been found to be common causes for malfunctioning filter floor systems:

- Filter nozzles break or are blown completely out of the filter bed.
- Media manages to penetrate through the filter floor into the under-floor plenum. Once in the under-floor plenum, the media is washed back up into the nozzle stems of *all* the nozzles, partially blocking the nozzles from the inside.
- Other debris finds its way into the backwash water supply system and gets similarly stuck in the inside of the nozzles.
- The seals between the edges of the suspended floor panels and the side of the filter box deteriorate and air and water preferentially flow up the sides of the filter box.

From the above, it is evident that the maintenance personnel should not be afraid to dig into a media bed to find and correct a problem. A number of precautions should be incorporated as standard procedure when this is attempted:

- Place plywood sheets around the area to be excavated and restrict human movement to these areas.
- When gravel-supporting layers are encountered, separate this upon excavation as far as possible.
- The gravel should be taken from the filter box and rinsed to remove all media grains before being placed back in the filter. The media should be prevented at all

costs to enter the under-floor plenum! Whereas a little gravel in the media layer will do no harm, a little media in the gravel layer could cause later problems.

- When walking directly on the filter floor, take care to use soft shoes and avoid the nozzle domes as far as possible. The filter nozzles are fairly delicate and will be damaged by heavy boots and careless walking.

The following pointers are offered for when and how action could be taken to keep the filter floor in good condition:

- When a broken or blown-out nozzle is detected (usually easy to spot visually), get to it as quickly as possible to prevent the massive leakage of media into the under-floor plenum.
- Some under-floor systems allow entry or partial entry into the under-floor plenum to flush or remove any media from the under-floor plenum. Do this as diligently as possible.
- Make sure to replace the nozzle with one of similar design – nozzles are not all alike and could have vastly different hydraulic properties. Avoid over-tightening, as this is often the cause of stripping the soft plastic thread.
- When leakage along a floor joint is detected, get professional advice on the best product to use and its correct application procedure.
- Treat any work on the backwash water supply line and sump with care to avoid the ingress of construction debris.

It stands to reason that not all problems require bed excavation. When small dead patches are spotted, for example, prod them with a steel bar during backwash first. The problem does not necessarily start at the filter floor, but could also be a local clumping or blockage within the media which is relatively easy to fix at an early stage.

Measuring filtration performance

Filtration has been explained as a dynamic process, with each filter potentially producing water of varying quality over time. Furthermore, different plant supervisors witness the filtration performance at different times. These factors establish two vital requirements of filtration monitoring, namely that of *frequent* measurement and *systematic recording* of measurements. Trends of short periods (comparable to the length of a filter run) may suggest problems of slow filter ripening or early breakthrough which will not show up with single infrequent snap samples. Likewise, a steady deterioration of performance of months or years will not be noticed unless it can be compared with a properly documented long-term history of plant performance.

The following guidelines for filtrate turbidity are relevant for South Africa:

- SANS 0241 requires turbidity values of less than 1 NTU for Class 1 water.
- SANS 0241 requires turbidity values of less than 0,1 NTU for Class 0 water.
- Most South African water supply authorities have accepted an internal production goal of 0,5 NTU or below.

- A common production goal of water supply authorities in the USA and Europe is 0,1 NTU or below.

A first concern is *where* the turbidity should be measured. To ensure that the production guidelines are met, the samples have to be drawn from the *combined* filtrate coming from all the filters. Such a measurement, however, will not show the turbidity patterns of individual filters or even indicate when one filter is malfunctioning amongst a block with multiple filters. To get the detailed picture of how each filter is operating, it is necessary to monitor the *individual* outlets of all the filters.

A second concern is *how* the turbidity is monitored. Ideally, it should be done with an on-line turbidimeter, with automatic data logging. As an alternative to on-line monitoring, the filters could be sampled and tested for turbidity every two hours. In both cases, the data should be captured in an electronic format which will allow subsequent recall and analysis.

Table B3.1: Practical considerations for setting up a filtration monitoring strategy.

	Manual sampling	On-line turbidimeter
Combined filtrate	Minimum requirement One bench turbidimeter required Partial record of compliance No indication of problem filters	One on-line turbidimeter required (additional to bench turbidimeter) Complete record of compliance No indication of problem filters
Individual filters	One bench turbidimeter required Sampling requires huge effort for large number of filters Only perform intermittently Partial indication of problem filters	Many on-line turbidimeters required (additional to bench turbidimeter) Calibration requires huge effort Complete record of compliance Complete indication of problem filters

Once a record of a specific treatment plant is available, it is prudent to develop more detailed site-specific criteria to alert the plant supervisor to more subtle changes in filtration efficiency. With reference to typical filter run (showed earlier), special attention should be paid to the following:

- The *filter ripening stage* should be kept as short as possible, and filtrate turbidity should be below 1,0 NTU at all times. It will be necessary to step up to the sampling frequency during this stage to get a meaningful picture.
- The filtrate should comfortably meet the production standard during the *production stage*. It is common practice to try to keep this value below 0,5 NTU or even 0,3 NTU.
- *Breakthrough* should be clearly defined. The breakthrough threshold could be defined, for example, at 150% of the average production phase turbidity, or at 1 NTU, whichever is lowest.

Getting everything right at the same time

Successful filtration depends on the combined success of three broad requirements. If any one of these requirements are not met, filtration will be less than optimal. A

successful operational strategy should therefore incorporate the necessary elements of all the requirements set out in the following sections.

Control of chemical pre-treatment

It is easy to see why good filtration requires exactly the same conditions as good flocculation. During flocculation, the objective is to make it easy for particles to approach, collide and stick to each other to form flocs. During filtration, it must be equally easy for the particles to approach, collide and stick to the specific deposit, which is, similar to floc, nothing but a collection of particles. The first step in improving filtration efficiency, therefore, is the optimisation of the chemical dosing strategy. If the flocculation is inadequate, then filtration performance will undoubtedly be equally disappointing. It is absolutely pointless to make filtration adjustments unless the pre-treatment is optimised first. Further filtrate improvement may only be possible through filter changes *after* the chemical dosing strategy and flocculation have been optimised.

Control of the filtration cycle

Filtration runs have to be terminated for one of three reasons:

- When the turbidity starts to break through. This can only be determined when the filtrate of each individual filter is monitored, as described earlier. Filters showing signs of breakthrough should be removed from operation immediately, regardless of any of the criteria following below.
- When the full clogging head of the filter is reached. The clogging head of a filter is predetermined by the hydraulic design of the filter and cannot be changed by the operator. It can, however, be observed when the flow through a filter starts to drop gradually towards the end of the filter run.
- When the filter has been operated for a certain length of time. The operator is responsible for ensuring that the filter run does not exceed a specified duration. This duration is determined after careful consideration of the many factors that impact on the quality of water produced by the plant and may therefore be different for different plants. In practice, this value ranges from a minimum of 24 hours to usually no more than 48 hours. In the case of covered filters during winter conditions (in other words when biological activity is at a minimum) this value may be as high as 72 or even 96 hours. Filter runs should however, generally be limited to 48 hours for the following reasons:
 - Floc can consolidate on the media grain which may lead to increased mudball formation, and
 - The passage of large mobile invertebrates through the filter bed into the clear water tank

If a filter has to be taken out of operation for whatever reasons, the following precautions are suggested:

- Whenever a filter run is interrupted, it must be backwashed before it is placed back into service. This is to remove the specific deposit, which will otherwise probably be dislodged from the media when the filter is put back into service.

- A filter that has been taken out of operation should be washed immediately after removal. This is to prevent the decomposition of the specific deposit which may lead to unwanted odour and taste. When a filter is taken out of service for media sampling or other testing, the tests must be performed as soon as possible and the filter must be washed immediately after the tests have been performed.
- For a filter that is out of service for a short period of a few days, the general rule is that the water level in the filter basin must remain approximately 100 mm above the media surface. The media should not be exposed and allowed to dry out, unless called for by tests that have to be performed.
- If a filter remains out of service for an extended period of more than a few days, it is best to drain the media completely to allow it to dry out, to prevent the growth of algae, mosquito larvae, etc. In this case, care should be taken to wet and soak the media thoroughly before putting it back into service, to prevent the partial floating and loss of media. Also, it is strongly suggested that such a bed is backwashed first before putting the filter back into operation.

Removing or returning a filter to service upsets the hydraulic equilibrium of the filter block and should be done in similar fashion to removing and returning filters to service during the backwash cycle, described further on in this chapter.

Control of the backwash cycle

Backwashing is the single most critical operation to be performed by the plant supervisor. If it is considered that every filter is washed about 10 000 times during a design life of 50 years, it is obvious that even a small but consistent error in the backwash sequence could eventually snowball into a major problem.

The first concern should be that the correct *sequence* of air and water is used, namely that air and water is used *consecutively* or *simultaneously*. It is important for plant supervisors to recognise that each system requires very specific air and water rates, and that is it *not* an operating decision to switch from one mode to the other without consulting with the plant designer first. If the backwash efficiency of a plant using air and water *consecutively* is not adequate, a better option is to use air-water-air-water for shorter periods to increase the efficiency.

The second concern is that the *rates* of air scour and water backwash are adequate:

- For air scour, the obvious check is to read the airflow meter, if such a meter was provided. If this is not possible, the airflow rate could be checked with the supplier if the details of the electric motor and the gear or pulley ratios are provided. Unfortunately, it is very difficult to visually gauge whether the airflow rate is sufficient. A typical air scour rate is around 7 mm/s, but the precise design value has to be found in the operational manual or from the designer.
- For water backwash, the water flow rate can be read from the backwash flow meter if such a meter exists. Another, more reliable measure can be obtained by direct measurement of the water rise rate in the filter box during an actual backwash. In this case, the backwash valve can be closed to allow a larger part of the filter box to fill for a more accurate measurement. A further visual indication is that the top of the media should show some movement or fluidisation during backwash.

What then causes the decline in the flow rates of air and water? One reason is that air blowers and backwash pumps are subject to unavoidable wear and tear. As impellers and rotors wear and tolerances become looser, the performance of the equipment will drop. Infrequent lubrication (in the case of blowers) or entrainment of filter sand from a backwash sump (in the case of backwash pumps) will greatly speed up the deterioration. Another reason is that the many valves on the backwash and air manifolds do not all shut perfectly every time. In fact, as valve seats wear and actuators develop a degree of play, the closure of valves gets significantly worse with time. This means that not all the air or water is delivered to the intended filter, but is inadvertently bled off to other filters which are not backwashed. A quick way to check for air leaks of this kind is to observe the other filters when a filter is air scoured. Any bubbling of air in a working filter is evidence of a leaking air valve. Leaks of backwash valves cannot always be spotted in this way, although careful listening to individual valves could indicate a leak.

A third concern is the *duration* of the air scour and water backwash. Air wash cycles should be long enough to properly scour the media grains. However, it was already mentioned that there is little point in continuing the air scour beyond two to three minutes, as the air will have formed channels at this point with little or no associated media movement. The water backwash should be terminated when there is a visible clearing of the backwash water.

A fourth concern is avoiding the *loss of media* during backwash. The largest fraction of media lost from a filter is generally lost during the changeover from water wash to air scour and also during the changeover from air scour to water wash. A first precaution therefore is to allow a minimum period of a minute between air and water cycles, to allow for the venting of air trapped in the bed. However, some air will still tend to remain trapped in the media, which then bursts to the surface when the water wash is started. To prevent that this air burst dumps media into the backwash trough, a second precaution is to allow the water level to drain to about approximately 100 mm below the wash water weir after the air scour cycle. Upon starting the backwash cycle, this allow some time for the air to escape before the water level reaches the backwash weir.

Ensuring smooth changes in flow rate

The perfect flow situation for a filter, as discussed before, is when the flow rate stays absolutely constant. Unfortunately, flow rate changes in individual filters are unavoidable. Whenever the raw water flow rate changes, or a filter is removed from or returned to service for backwashing or any other reason, adjustments in flow rates are necessary. It is the task of the plant supervisor to manage these changes such as to minimise their detrimental effects on filtrate quality.

Small changes in *raw water flow rate* are normally addressed automatically by the hydraulic flow control system. As the raw water flow rate increases, for example, either the water level in all the filters will rise slightly, or all the downstream flow control valves will open marginally (depending on the type of flow control system of the filter block). As a general rule, each individual filter should be operated at a minimum rate of 50% to 80% of its design flow to ensure that the flow control system works satisfactorily. At a lower rate, the control valve may have to be operated in an

almost-closed position which makes flow control inaccurate and inconsistent. If a large raw water flow reduction is required, it will therefore be better to operate a smaller number of filters closer to capacity than to allow all the filters to operate too far below capacity.

Whenever a filter is *removed* from service, for backwashing or otherwise, the overall hydraulic load has to be redistributed amongst the remaining filters. The removal must be done in such a way that it does not result in a shock-load on the filters that remain in production. In the case of a plant with four filters, the potential for this is can be quantified:

- If four filters are in operation and one is removed for washing, the filtration rate in the remaining three remaining filters has to increase by 33%
- If one of four filters is removed for maintenance, only three filters remain in operation. If one of these is then removed for washing, the filtration rate in the remaining two remaining filters has to increase by 50%!

These increases are significant and require special attention. Some options are:

- Before flows through operational filters are *increased*, consider whether or not it is possible to *introduce* additional filters into service. The “spare” filter(s) must be introduced into operation at the same rate as the operating filter is removed from service. The goal is to limit or avoid any variation in filtration rate on any of the other filters that remain in service.
- Before flows through operational filters are significantly *decreased*, consider whether or not it is possible to *remove* filters from service. This will leave spare filters to introduce when the flow increases again.
- Should it be necessary to increase the production rate of a filter this should be done as slowly as practically possible, say over a period of at least 10 minutes.
- Flow to the filter that is to be removed from service should be closed down slowly over at least 10 minutes to allow for the gradual re-distribution of flow to other available filters.
- If entire banks of filters are to be commissioned, flow can be introduced to all filters simultaneously so that flow increases gradually in all the newly commissioned filters. When treatment plants are operated intermittently in off-peak energy periods (an unfortunate operational choice discussed earlier), then each plant re-start has to be treated similar to the commissioning of a new plant.
- Filter outlet valves for the filters that are placed in operation should be opened as soon as possible so that the water level in the filters build up slowly and consequently leads to a gradual increase of the filtration rate in that filter.

The role of the plant supervisor

It is true that the plant supervisor does not have many degrees of freedom at the filtration plant. Once the plant is built, the hydraulics, layout, filtration and backwash rates, filtration and backwash control systems, media selection, nozzle choice and almost everything else have been fixed. There are, however, three most important duties remaining which the plant supervisor, and the plant supervisor alone, can perform.

Firstly, the plant supervisor should know that good filtration can only follow after optimal chemical coagulant selection and dosing. While the laboratory jar test may be a simple, powerful way to determine the optimal range of chemical dosing, the final test is the quality of the filtrate. If the filtrate does not meet the requirements, then the pre-treatment should be checked first.

Secondly, there are a number of routine maintenance items which should be diligently performed. The washing of filter walls and outlet boxes, the cleaning of probes, the detection of small dead spots and breaking them up manually, the quick replacement of a broken nozzle or the removal of floating material before it gets into the media fall into this category.

Thirdly, the plant supervisor forms the first line of defence to recognise and identify potential problems at filtration plants. Specialists do not routinely visit treatment plants, unless they are called to do so. The plant supervisor therefore has to be the ears and eyes of the specialists, even for those items that require outside help. For example:

- A consistent problem with air bubbling during water backwash should be referred to the filter designer.
- A problem with valves that do not seal properly or a pump that delivers less than expected, should be referred to the mechanical maintenance team.
- The need for incorporating a slow-start into the filtration control system should be brought to the attention of the filter designer and the software programmer.

The remainder of this chapter is devoted to a series of simple tests, precautions and actions which will assist the plant supervisor in performing this important duty. The many practical technological and size variations of filtration plants preclude a detailed checklist of action items and their required frequencies, but the guidelines that follow should enable each plant supervisor to develop a detailed operational guideline tailored to the needs of a specific treatment plant.

A systematic approach to troubleshooting

What to do if filtrate turbidity is not acceptable? The American Water Works Association Research Foundation provides a useful four-step approach to systematic troubleshooting. The following questions have to be sequentially addressed:

- Can the measurements be trusted?
- Is the pre-treatment sufficient for the water currently being treated?
- Is the operation correct and suitable for the water currently being treated?
- Is the maintenance up to date?

As one goes down the list, the more serious the implications are in terms of the cost and time required to rectify a problem. Each of the four questions forms the focus of a series of investigations that are summarised in the tables below.

Check No.1 – Instrumentation.

Turbidity instrumentation checklist: Ensure you can trust what your instrument tells you

Check whether the turbidimeters are calibrated correctly Check the measuring vial(s) for cleanliness and scratches Check whether the sample is representative Check whether the sampling procedure is sound
--

Check No.2: - Pre-treatment.

Pre-treatment issues that may cause filter turbidity problems.

Check if anything is blocking the chemical addition points Check for proper chemical mixing Check coagulant dose is set at its required value Verify the dosing rates required with jar tests Check for poor floc retention in the flotation and/or sedimentation units Check chemical feed day tanks are not empty Check that dilution/carrier water supplies are functioning acceptably

Check No.3 – Operation.

Operating issues that may cause filter turbidity problems.

Check current position of the filter in the filtration cycle. Has the filter run extended into breakthrough or is the filter still within a ripening stage? Check the backwash operation and take the filter out of operation if the previous backwash was not performed properly Check that the flow rate is acceptable and that the filter is not operating outside of acceptable limits Check that the filter is not being operated at excessive headloss Carry out a backwash to end the filter run Consider implementing techniques for managing filter ripening
--

Check No.4 – Maintenance.

Maintenance issues that may cause filter turbidity problems.

Check that the filter contains the correct depth of filter media Check the filter media condition: look for an even flat surface, watch out for mudballs and cracks Watch filter backwash: check for even distribution of air scour and backwash water Check backwash bed expansion Check backwash rates.

Maintenance of mechanical and electrical components

The importance of properly functioning mechanical components and instrumentation have been stressed in earlier sections. It is neither appropriate to cover here the broad spectrum of equipment encountered at a filter block, nor to suggest an adequately structured maintenance schedule. It is, however, necessary to make the important point here that the maintenance of filter block components should be done on a *routine*,

preventative basis. The success of filtration does not only depend on *whether* equipment is working, but on the assumption that they work *effectively* and *accurately*. For this reason, frequent calibration, lubrication and overhaul, according to the manufacturers' specifications, should form the basis of the maintenance programme.

Testing of the filter media

The filter media plays a central role during both filtration and backwashing. Furthermore, it is common to find filter media at treatment plants which is different from the media placed in the filters when they were new. Some of the media lost may have inadvertently been replaced with media specified differently, or the media may have changed due to chemical deposits. The systematic inspection and testing of filter media is therefore one of the critical items to check if a problem with inadequate filtrate quality persists.

Visual inspection after filtration

Immediately after a filtration cycle, the filter should be regularly inspected at close range, with the water drained to the surface of the media. The objective is to ascertain whether the full bed contributes to the filtration cycle and that there are no dead spots in the bed. The following are tell-tale signs of filter bed problems:

- Dead spots in the filter, characterised by smaller areas with a slightly depressed area, a layer of fine mud on the surface and often a different colour than the surrounding media bed.
- Random cracks in the media bed.
- “Pulling away” of the media bed from the sidewalls.
- Also usually evident is a disruption of the media surface at the points where the influent water enters the filter bay. This is almost impossible to avoid completely, but the depth of scouring should not be more than 100 mm below the media bed surface.

Visual inspection during backwash

The entire backwash cycle should be regularly closely observed in good light. The following are danger signs that should be looked out for:

- When the air first enters the bed, it should spread evenly from the inlet end until the whole bed is covered. Very aggressive, uneven air spreading points to a poorly designed air inlet which should be referred to a filter design specialist.
- During air scour, certain spots may appear “dead” (indicating dead spots, blocked nozzles or a physical obstruction in the bed such as a submerged plastic bag) while others may “sputter” much more violently than the surrounding areas (indicating a lost or broken nozzle).
- During backwash with water, “boils” may be observed at certain areas which indicate a lost or broken nozzle.
- During backwash with water, certain spots may continuously “burp” air, leading to media loss if the area is near the backwash trough. This may be eased by waiting longer between air scour and backwash for the air to be vented from the under-

floor volume or by having the air release system improved by a filter design specialist.

- The backwash water should evenly become cleaner over the entire length of the filter bed. A continuously dirty “streak” indicates a problem spot which is cleaned at a slower rate than the rest.

Characterisation of dried filter media

The first step is to determine the size of the media grains. This is done by taking a representative sample, usually by plunging a core sampler into the bed at say four different positions to a depth of about 400 mm and extracting a plug of the media. (A thin-walled stainless steel pipe with an internal diameter of 35 mm was found to work well, with a globe valve at one end to provide a partial vacuum when the sample is extracted from the bed.) If a surplus of sample is available, its volume is best reduced with a riffle splitter commonly used in a geotechnical laboratory. The sample is placed in a container and gently washed by hand under flowing water until the sample is clean. After drying in an oven for 24 hours at about 100°C, the sample is sieved through a stack of sieves to obtain a *size grading* analysis. The size grading analysis provides the following information:

- The coarse fraction of the media (usually taken as 2 mm for silica sand) should be less than about 5%. A media sample often inadvertently includes some gravel particles from the supporting layers higher up in the bed, which will completely skew the analysis. In this case, it is suggested that the gravel particles are hand-picked from the coarsest sieve, the sieve reweighed and the analysis repeated.
- The fine fraction of the media (usually taken as the fraction passing the 500 µm sieve) should be small, usually less than 3%.
- The effective size d_{10} , taken as the hypothetical sieve size which will pass exactly 10% of the media. For silica sand, this value should be between 0,55 and 0,75 mm.
- The coefficient of non-uniformity, taken as d_{60}/d_{10} , is an indicator of the spread of the media sizes. As effective filtration requires media that is uniformly graded, this value should not be more than about 1,45.

Characterisation of filter media after acid treatment

If the media, tested as described above, does not comply with the commonly accepted criteria, the analysis has to be continued. Were the filters charged with incorrectly specified media in the first place, or did the media size change through chemical deposition during the time since commissioning? Take, dry and weigh a sample as before and cover with water. Gently add a strong acid in small increments (20% hydrochloric acid was found to work well) and stir until all foaming and bubbling cease (using all the necessary safety precautions when working with acid). Rinse the media, dry and weigh again. The weight difference, expressed as a percentage of the original dry mass, is a measure of the acid solubility and should not exceed about 5%. If it does, a size grading analysis can be repeated on the sample after the acid had been added. This should indicate whether the media size had significantly been altered by chemical deposition.

Measurement of specific deposit

A final media test that should be occasionally performed by treatment plant personnel is the estimate of the specific deposit left on the media after plant backwashing. Ideally, the media should be perfectly clean after a plant backwash, but practically this can never be attained. The remaining specific deposit, however, is an indication of how effective the plant backwashing system is. A specific test that was found to be of great value at a number of South African treatment plants is the following:

- Take a representative media sample from the filter bed after the bed had been backwashed.
- Let the sample drain on a porous surface for at least one hour.
- Transfer about 60 ml of media (about 4 tablespoonful) of the sample to a glass container and determine its moisture content (MC expressed as a percentage) by weighing, oven drying and weighing again. The moisture content will typically be between 10% and 25%.
- Take 60 ml of media, determine its wet weight (WW) and transfer to a 250 ml measuring cylinder.
- Add 100 ml of water, stopper the cylinder and invert 10 times (one inversion being a turn downwards, a second of waiting and another turn upwards). Immediately transfer the 100 ml of dirty supernatant to a 500 ml beaker or Erlenmeyer flask.
- Repeat the previous step four more times until 500 ml of supernatant had been collected.
- Determine the total suspended solids (TSS) of the supernatant with the standard method.

The specific deposit (SD) can now be calculated in two steps. First calculate the dry weight (DW) of the sample:

$$DW = WW * (1 - MC/100) \quad (\text{result in g})$$

Finally, calculate the SD:

$$SD = TSS / (2 * DW) \quad (\text{results in mg/g})$$

The specific deposit SD is a direct measure of how much dry solids (in mg) are deposit on 1 g of clean filter media. As an example, a media sample with WW of 57 g has a MC of 23% and yields 500 ml of supernatant with TSS of 140 mg/l. The DW is calculated as 43.9 g and the SD as 1.59 mg/g.

It should be emphasised that the above test is not a trivial test and that it first should be performed a number of times for good reproducibility. However careful it is performed, it can easily be compromised if a small mud ball happens to be included in the teaspoon of sand sampled. Such an unwanted effect can be minimised by the following precautions:

- Scrape the top 10 mm of the bed (where most of the mudballs are to be found) clean before taking a sample

- Perform the entire analysis, including the sampling and stripping of the specific deposit by inversion) in triplicate and reject any outliers before taking the median of the results.

A specific deposit SD of less than 6 mg/g indicates a clean bed, with a value below 3 mg/g suggesting a very clean bed. Above 6 mg/g the bed is unusually dirty and above 10 mg/g there is a problem that requires expert advice and attention.

The remediation of filter media

It is difficult to clean media once it has been fouled. Short of removing all the media from the filter boxes and replacing with new or manually washed media, the plant supervisor has two *in situ* options for trying to rehabilitate the media, or prevent it from fouling. These are *multiple washing* and *chemical treatment*. The results from a solids retention analysis will provide guidance on the particular method to employ.

Multiple wash

A multiple wash (also referred to as a “birthday” or “maintenance” wash) is simply the normal filter wash procedure, repeated a number of times (generally two to three times) before the filter is placed back in operation. A filter should be subjected to a multiple wash at least once per month unless any of the following is true:

- If raw water turbidity or chlorophyll-a levels are high, the filters should be subjected to a multiple wash once in two weeks.
- If polymers are used as primary flocculant, then the filters should be subjected to a multiple wash once in two weeks.
- If a measurement of specific deposit indicates values of 6 mg/g or more, multiple washes should be performed every two weeks until the specific deposit drops to below 6 mg/g. If this does not work, then chemical treatment should be considered.

Chemical wash

A chemical wash of the media consists of a chlorine or acid wash of the media and a high-pressure jet wash of the walls. A filter should be subjected to a chemical wash at least once per year, unless the specific deposit tests indicate that this is required more often. Generally chlorine granules are used for this purpose but mild acids, detergents as well as a number of commercial “cocktails” are also available for this task. Since this task involves the use of potentially dangerous and expensive chemicals it is advisable that the chemicals be tested on bench scale before they are applied to the filters. This is done to determine:

- Whether the chemical has the required effect
- What “dose” of the chemical is required
- What will the effect of the chemical be on the other filter components that come into contact with the chemical (filter basin, pipes, valves, rubber seals, plastic components, etc.)
- What will the cost and down-time effects be?

One practical example of the application of chlorine granules are as follows:

- Select the filter to be washed and remove it from service
- Subject the filter to a multiple wash. Wash the walls of the filter with a high-pressure jet at the same time.
- Drain the bed to expose the media after the media after the wash has been completed.
- Perform a specific deposit test for reference purposes.
- Spread a predetermined amount of granular calcium hypochlorite (HTH) over the surface of the bed and work it into the top layers of the media with spades. (The chlorine dose can be optimised over time; an initial dose concentration of 100 g/m² of media surface can be considered.)
- Submerge the media again but do not let the water pass over the backwash weir.
- Mix the water in the bed well using the air blowers. One minute of blowing should suffice.
- Let the bed stand with the chlorine for 24 hours. The bed should be mixed every 4 hours during this period using the air scour facility.
- Subject the bed to a multiple wash at the end of the 24 hours
- Measure the specific deposit again to determine the success of treatment.

Other types of filters

Granular filtration comes in many shapes and sizes. This chapter discusses only the details of constant rate, rapid gravity filters as they constitute the vast bulk of the total SA filtration capacity. The opportunities for *slow sand filtration* are very limited in SA due to high turbidity peaks and/or excessive algal growth potential in almost all surface waters. Likewise, the use of *pressure filtration* driven by pumps is confined to very small rural plants, which normally have to contend with a range of others problems unique to these plants and for which more specific guidelines have been published. There are also a limited number of *up-flow filtration* and *declining-rate filtration* plants in SA. Nevertheless, the fundamental principles of filtration, as discussed in this chapter, apply across the whole spectrum of granular filtration applications.

CHAPTER B4: DISINFECTION

John Geldenhuys

INTRODUCTION

The purpose, role and place of disinfection in the overall water treatment process

The objective of water treatment is to produce a final product that is microbiologically and chemically safe for consumption as well as aesthetically acceptable. The range of treatment processes required to achieve this goal includes coagulation-flocculation, sedimentation or flotation, filtration and disinfection. Depending on the source and the nature of the raw water, one or combination of these processes is used to prepare the water physically and chemically for the essential final stage of disinfection. Whilst each of the treatment processes is able to reduce the overall number of microorganisms, they can never ensure the complete removal of such. Therefore the reduction of pathogens by the physical treatment processes should merely be considered an added benefit.

The combination of unit treatment processes forms a multi-barrier approach, in which each process step can be regarded as a conditioning of the water for effective and reliable disinfection. Final disinfection is the most important stage of water treatment and is a process specifically designed for the reduction of the number of pathogenic organisms present. As disinfection is the final safeguard against water-borne microbial disease, the application of disinfectants is of utmost importance as it also is the last point at which the water quality can be affected.

It is essential that disinfectants and their dosage rates are selected such that the chemical demand of the water is satisfied and the desired residual after initial contact is achieved and maintained throughout the distribution system up to the consumer. Regular monitoring of disinfectant residuals at the purification plant and throughout the distribution system, in parallel with microbiological examination, is essential to evaluate and control the disinfection process.

In addition to the destruction of pathogens, a further advantage of disinfection is that the general microbiological quality of the water is also improved. This helps to maintain the water quality in long distribution lines and reticulation systems.

The introduction of two water treatment processes, namely filtration and chlorination, had a significant impact on reducing the number and severity of incidents of water borne diseases. In fact, there is an inverse relationship between incidents of water borne disease and the application of these unit treatment processes. The chlorination of potable water on a continuous basis was most likely first performed at Middelkerke in Belgium in 1902. Subsequently, many installations were built where chlorine was used as the disinfectant, often to primarily combat a specific epidemic or outbreak of disease and then later as a permanent unit treatment process.

In the preparation of drinking water the term disinfection is used to describe the process of destroying or inactivating pathogenic organisms. This is not the same as sterilisation, which is the killing of all forms of life. The sole purpose of disinfection

of drinking water is to specifically destroy pathogenic organisms, thereby eliminating the possibility of water-borne diseases.

A variety of pathogenic organisms capable of transmission by the faecal–oral route may be found in raw water sources and wastewater. Waterborne outbreaks of shigellosis, salmonellosis, cholera and various viral agents have been reported, in many cases associated with sewage-contaminated water supplies. Amongst the bacteria, *Salmonella*, *Shigella*, and *Vibrio cholerae* organisms are the classic agents of concern. In more recent times, this concern has extended to other biological entities such as viruses and protozoa that are associated with contaminated water. Viruses such as enteric viruses (ECHO virus, Coxsackievirus), rotavirus, reovirus, adenovirus and parvovirus have been isolated from wastewater. Important disease causing viruses that have also been isolated from water include the Norwalk and caliciviruses. In addition, significant concerns have increased over the risk from pathogenic protozoa in drinking water, particularly *Giardia* and *Cryptosporidium*.

All of the above organisms are capable of causing severe infections that could reach endemic proportions if not controlled properly. Some of the most common water-borne diseases prevented by disinfection are shown in Table B4.1.

Table B4.1 Some common water-borne diseases prevented by disinfection

Some common water-borne diseases prevented by disinfection		
Bacterial	Viral	Parasitic
Typhoid fever Para-typhoid Childhood bacterial diarrhoea Cholera	Hepatitis Rotavirus diarrhoea	Amoebiasis

TYPES OF DISINFECTANTS AND MODES OF DISINFECTION

Mircoorganisms can be removed, inhibited or killed by various physical processes, physical agents or chemical agents.

- Physical processes: These include gravity separation and filtration. Gravity separation (sedimentation and flotation) and filtration play a very important role in the removal of bacteria, viruses and protozoan cysts. It is of utmost importance that these processes are optimised as protozoan cysts are largely resistant to chemical agents and their removal is primarily dependent on efficient coagulation–flocculation, sedimentation and filtration.
- Physical agents: Include heating and irradiation. Heating water by boiling or by solar energy in small transparent containers (in which both heating and ultraviolet light (UV) radiation plays a role) is only possible on a very small scale and is more suited to situations where no other form of disinfection is available. Concentrated UV light as a mode of disinfection for drinking water is gaining popularity and has been proven to be very effective in the inactivation of microorganisms.

- **Chemical agents:** These are by far the most popular means of disinfection in the drinking water industry and many alternatives, each with its own particular application, are available. The most commonly used chemicals are chlorine gas (Cl₂), calcium hypochlorite [Ca (OCl)₂], sodium hypochlorite [NaOCl], chlorine dioxide [ClO₂], monochloramine [NH₂Cl], ozone [O₃], hydrogen peroxide [H₂O₂], potassium permanganate [KMnO₄], iodine [I₂], and bromine [Br₂]. While the chlorine based disinfectants have historically been the most popular products to use, the unique properties of other compounds such as ozone have caused a rapid increase in their use.

Only the disinfection methods that are considered practical for the supply of drinking water to communities, from very small to very large, will be discussed here. This will exclude methods such as heating and filtration, although the value of effective filtration for the removal of pathogenic protozoa cannot be understated.

PHYSICAL AGENTS USED FOR DISINFECTION

Irradiation with ultraviolet (UV) light

Table B4.2: Summary of the main features of UV irradiation for disinfection.

Method of application	Equipment required	Mechanism of action against microorganisms	Advantages / Positive aspects	Limitations / Negative aspects
<i>In situ</i> generation and application of UV light at the optimum wavelength, intensity and fluence* in a contact chamber that ensures a thin water film for good penetration and maximum exposure to the UV light.	Low, medium or high-pressure UV-generating lamps that emit light at the desired wavelength in the germicidal range. Optimum wavelength is 254,7 nm.	Disruption of the genetic material (DNA) and membrane structure of the microorganisms.	No chemical compounds added to the water. As far as can be determined no negative by-products are formed. Effective against chlorine resistant organisms.	Turbidity and concentration of organic compounds that absorb UV light energy must be as low as possible. No disinfectant residual remains. No easy way of measuring the fluence.

*Fluence = dosage

Ultraviolet light as a method of disinfection is to some extent effective against the chlorine resistant protozoa *Giardia* and *Cryptosporidium*. These organisms are only removed effectively by optimised sand filtration or inactivation by UV light. A fluence of at least 40 mJ/cm² is required to achieve a 3-log inactivation of the protozoa under optimal conditions. The required dose is affected by the amount of UV light that may be absorbed by impurities in the water such as suspended matter and dissolved organic compounds. In terms of suspended matter, it follows that the higher the turbidity of the water the higher the UV dose required.

The relative effect of the dissolved organic matter is expressed as the Specific Ultra Violet light Absorbance (SUVA), which is the relationship between the amount of UV light absorbed at 254 nm/cm and the dissolved organic carbon concentration (DOC mg/l).

It is advisable to make use of specialised computer design and validation models in the planning and selection of a UV light disinfection system, especially those with large capacities. The UV light intensity distribution (LID) and computational fluid dynamics (CFD) models are used to simulate flow through the units and predict the performance of the UV unit.

UV light disinfection does not produce any measurable or persistent residual and consequently does not provide any protection against the multiplication or after growth of microorganisms. It is therefore advisable to follow UV light disinfection with a chemical based disinfectant that has the capacity to form a persistent residual. Free available chlorination or chloramination can provide this requirement.

CHLORINE AND CHLORINE BASED COMPOUNDS THAT RELY ON THE ACTIVITY OF THE HYPOCHLORITE ION (OCl)

The chemicals that fall into this category are liquid chlorine gas and sodium - and calcium hypochlorite, since the active disinfection agent is the presence of the hypochlorite ion, which will form hypochlorous acid in water according to one of the following reactions:

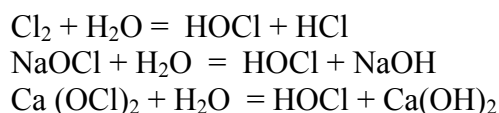

These compounds are applied in the following forms: liquid chlorine extracted in the gaseous form (or liquid evaporated to form a gas) from a storage cylinder, sodium hypochlorite in the liquid form and calcium hypochlorite in powder form. Calcium hypochlorite can also be dissolved in water before addition.

The addition of chlorine gas will reduce both the alkalinity and the pH of the water, while the other two compounds will increase the pH. In practice, it has been found that a dosage of 1 mg/l of chlorine will reduce the alkalinity by approximately 0,7 mg/l as CaCO₃ and the pH by about 0.3 pH units. This is an approximation only as the pH change will also be affected by the water quality and chemical composition (predominantly the alkalinity).

Use of chlorine compounds that rely on the activity of the hypochlorite ion (OCl)

Table B4.3: Summary of the main features of hypochlorite ion disinfection.

Method of application	Equipment required	Mechanism of action against microorganisms	Advantages / Positive aspects	Limitations /Negative aspects
Respectively in gaseous, liquid or powdered form, depending on the compound used with purposely designed equipment that can be calibrated.	Liquid chlorine is abstracted in the gaseous form (or as a liquid evaporated to form a gas) and mixed with carriage water, which is used to dose. Sodium hypochlorite can be applied with dosing equipment suitable for liquids. Calcium hypochlorite can be applied by dry powder feeders or in solution form.	The active hypochlorous acid formed when these compounds are mixed with water is affected by pH. The neutrally charged HOCl form has the ability to penetrate microbial cell walls to disrupt cell membranes and enzymatic systems.	Compounds are readily available. Relatively easy to apply. Forms an active residual. Residuals can be measured accurately.	Compounds are dangerous and must be handled with care. Potentially harmful chlorinated byproducts may be formed with organic compounds. The negatively charged OCl ⁻ formed at high pH (>7,5) is less bactericidal than HOCl.

PRIMARY DISINFECTION WITH CHLORINE

Chemical reactions of chlorine, sodium hypochlorite and calcium hypochlorite in water and implications for disinfection.

Free available chlorine

When gaseous chlorine is added to water the following reaction takes place to yield hypochlorous acid (HOCl) and hydrochloric acid (HCl).

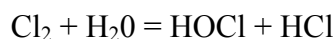

The HOCl dissociates according to the following reaction to form the hydrogen and hypochlorite ions. This reaction is pH and temperature dependent and has a significant effect on disinfection efficiency.

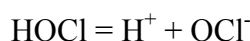

Sodium- and calcium hypochlorite react in a similar way in water according to the following reactions:

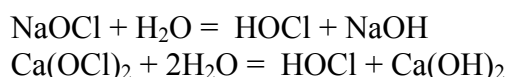

When hypochlorous acid is present in water that contains insignificant quantities of total Kjeldahl nitrogen (TKN), organic material or other chlorine-consuming substances, a rapid equilibrium is established amongst the chlorine species (HOCl + OCl⁻ + H⁺) in the solution as indicated by the reactions above. In such circumstances, if the chlorine is not consumed in any other way, the chlorine concentration in the water will increase proportionately with the amount added.

The term free available chlorine is used to refer to the sum of the concentrations of molecular chlorine (Cl_2), hypochlorous acid (HOCl) and hypochlorite ion (OCl^-) present, each expressed as free available chlorine.

Because of its specific properties, hypochlorous acid is the most active and strongest bactericidal species of the available chlorine compounds. As a bactericide it is approximately eighty times more effective than the hypochlorite ion. It would therefore be desirable to have the highest proportion of the free available chlorine in that form.

The effect of pH on the dissociation of hypochlorous acid is illustrated in Figure B4.1. Table B4.4 gives the relative concentrations of hypochlorous acid and hypochlorite ion at a free available chlorine concentration of 1,4 ml/l at 15 °C. From this it can be seen that at the normal pH of drinking water, 7,5 to 8,7, and dependent on temperature, only 15 to 22 % of the free available chlorine will be in the hypochlorous acid form. At higher pH levels the HOCl portion is drastically reduced.

Figure B4.1: The effect of pH on the dissociation of hypochlorous acid

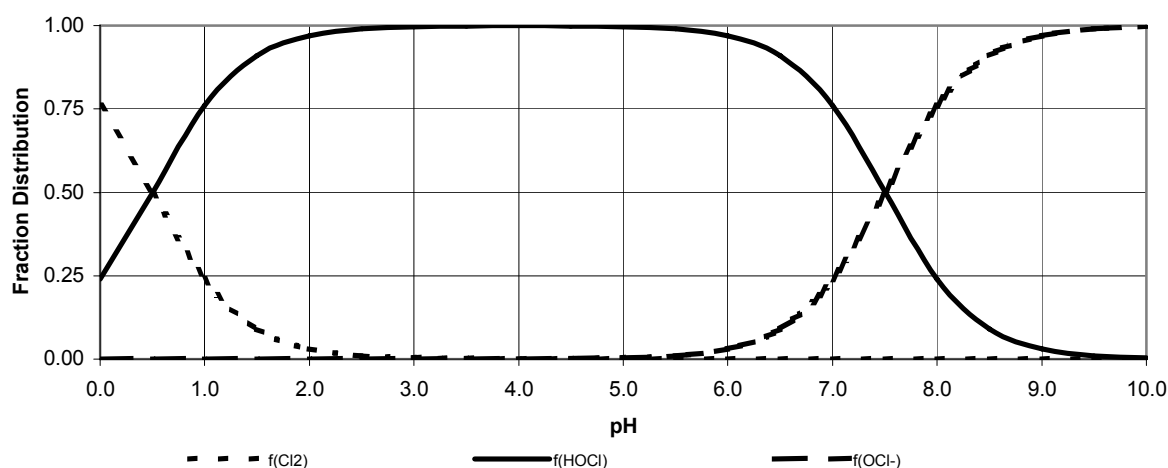

This reduction in hypochlorous acid at higher pH does not mean that only the non-ionised portion of hypochlorous acid will be consumed and be active against microorganisms. The reservoir effect of the OCl^- ion implies that as soon as the HOCl has been consumed, *i.e.* reduced to the chloride ion, more HOCl is immediately formed from the OCl^- ion and H^+ ion to maintain the chemical equilibrium according to LeChatelier's principle.

Table B4.4. The effect of pH on the distribution of hypochlorous acid (HOCl) and the hypochlorite ion (OCl⁻) at 1,4 mg/l free available chlorine at 15 °C

pH	Hypochlorous acid		Hypochlorite ion	
	mg/l	as% of total	mg/l	as % of total
7,5	0,82	58	0,58	42
7,6	0,74	52	0,66	48
7,7	0,66	47	0,74	53
7,8	0,58	41	0,82	59
8,0	0,43	30	0,97	70
8,1	0,37	26	1,03	74
8,2	0,31	22	1,09	78
8,3	0,26	18	1,14	82
8,4	0,21	15	1,19	85
8,5	0,17	12	1,23	88
8,6	0,14	10	1,26	90
8,7	0,12	8	1,28	92

Breakpoint chlorination

In the presence of certain dissolved constituents in water, chlorine may react and be converted to a less reactive chemical form. The reaction between chlorine and any compound containing a nitrogen atom with one or more attached hydrogen atoms will form compounds classified as N-chloro compounds or chloramines. There are two distinct classes of chloramines, being the organic and inorganic chloramines. Chlorine may also react with ammonia and amino-nitrogen compounds such as proteins. In the presence of ammonia ion, free available chlorine reacts in a stepwise manner to form chloramines. This process is depicted in the simplified reactions below:

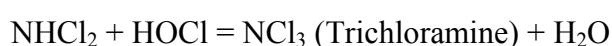
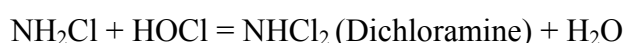
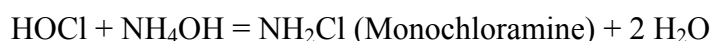

The compounds monochloramine (NH₂Cl), dichloramine (NHCl₂) and trichloramine (NCl₃) each contribute to the total chlorine residual in the water. The term total available chlorine is used to indicate the sum of the free available chlorine and the reactive chloramines.

As indicated earlier, if there is no ammonia or ammonia-based compounds present the chlorine concentration in water will increase proportionately to the amount added. When the ammonium ion is present, the available chlorine concentration in the water does not increase proportionately to the amount of chlorine added, due to the reaction between chlorine and the ammonium ion. The process through which the ammonium compounds are oxidized is called “breakpoint chlorination.” This phenomenon is illustrated in Figure B4.2. When progressively more chlorine is added and reacts with the available ammonium compounds, the measurable chlorine concentration (only detectable as combined chlorine) will increase up to a maximum point indicated by the “hump” in the diagram (Zone 1). If more chlorine is added, the detectable chlorine concentration will decrease until a minimum is reached at the “dip” in the

curve, as oxidative destruction of combined residual chlorine/ ammonium compounds accompanied by loss of nitrogen occurs (Zone 2). Finally, after the ammonia nitrogen has been oxidized completely the chlorine residual will consist almost exclusively of free available chlorine. Therefore, if more chlorine is added beyond this point, the free available chlorine concentration will increase in proportion to the amount added (Zone 3).

Under optimal conditions the molar ratio between chlorine and ammonia nitrogen at the breakpoint is 2:1, which corresponds to a mass dose ratio of $\text{Cl}_2:\text{NH}_4$ (as N) of 7,6:1.

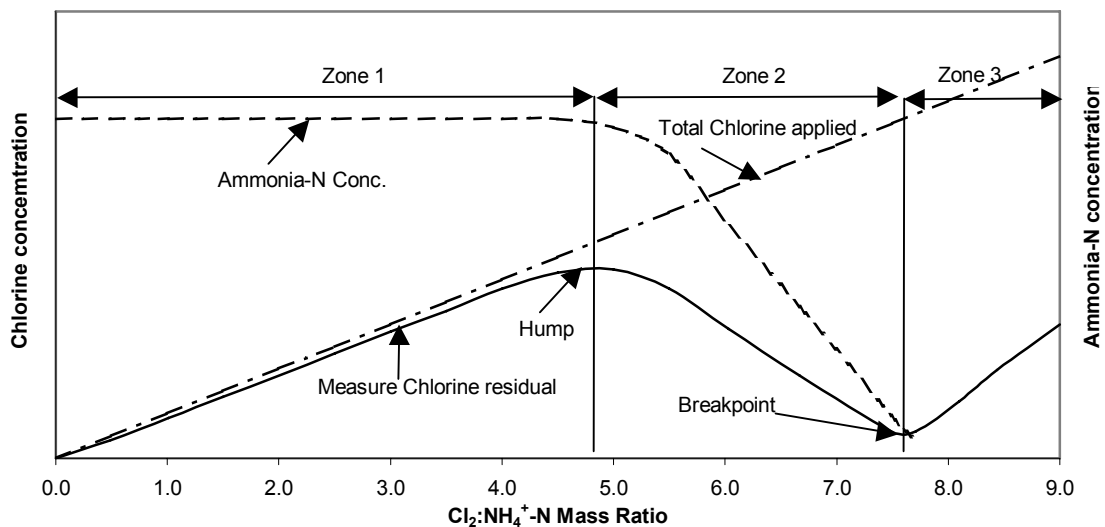

Figure B4.2: Breakpoint chlorination curve

Combined residual chlorine

If the water being chlorinated contains a very low ammonium ion concentration (e.g. less than 0,05 mg/l), breakpoint is reached very rapidly after chlorine addition. Only a small amount of chlorine is consumed in the process. Other nitrogen containing compounds present at low concentrations also react with chlorine. These reactions are slower than with the ammonium ion and the chloramine-compounds that are formed are quite stable.

It is therefore possible that chlorination may follow the typical breakpoint curve until the point where the available chlorine concentration reaches a minimum and free available chlorine concentrations will increase proportionately with further chlorine addition. However, after some time has elapsed, other chloramine-compounds may start to appear after reactions between the (less reactive) naturally occurring organic nitrogen compounds and free available chlorine. These compounds are formed through slow reactions and the concentration of these compounds increase only slightly, even with prolonged contact with chlorine.

It is of importance to note that the relative concentrations of the free chlorine residual and the combined chlorine residual within the total chlorine concentration changes continuously. On the one hand the free residual chlorine concentration is rapidly

depleted through a number of fast reactions and on the other hand, the concentration of the combined residual chlorine concentration remains constant or slowly increases.

The bactericidal or bacteriostatic effect of the “natural organic/chlorine compounds” is low compared with that of free residual chlorine and monochloramine. After some contact time and after the more reactive chlorine species have been consumed, the chloramines of natural organic origin may comprise a large portion of the total residual concentration and may account for all the residual chlorine that can be measured. These compounds have relatively poor bactericidal effects and do not contribute much to improve or maintain the microbiological quality of the water.

The fate of chlorine that has been added to drinking water may therefore be summarised as follows:

- A small amount is consumed to satisfy the immediate chemical demand created by oxidisable compounds, which includes the amount required to reach breakpoint.
- A measurable amount will react with nitrogen containing compounds such as ammonia (NH₃) to form relatively stable chloramine-compounds measured as combined chlorine residuals.
- Any additional chlorine added in excess to what is required to reach breakpoint will appear as free available chlorine.

CHLORINE-BASED COMPOUNDS THAT RELY ON THE ACTIVITY OF CHLORAMINE COMPOUNDS (PREDOMINATELY NH₂Cl)

Chloramination

Use of chlorine compounds that rely on the activity of monochloramine (NH₂Cl)

Table B4.5: Summary of the main features of monochloramine disinfection.

Method of application	Equipment required	Mechanism of action against microorganisms	Advantages / Positive aspects	Limitations /Negative aspects
<i>In situ</i> formation of monochloramine by the mixing of chlorine and an ammonium compound.	Equipment to dose chlorine in the gaseous form, as a hypochlorite solution or as a powder. Equipment to dose ammonium compounds in liquid form or as ammonia gas.	The monochloramine (NH ₂ Cl) is neutrally charged and can penetrate microbial cell walls to disrupt cell membranes and enzymatic systems.	Produces a long lasting bacteriostatic residual. Effective against attached microorganisms in biofilms. Does not produce chlorinated byproducts. Residuals are easy to measure.	Weak bactericide. If the Cl ₂ :NH ₃ ratio is too high (i.e. >5), di- and tri-chloramines could form which will impart taste and odour to the water.

Uncontrolled or unintentional chloramine formation takes place when chlorine is added to water that contains naturally occurring ammonium compounds. If breakpoint is not reached, chloramines will remain as the primary products that are formed. Chloramination is the controlled addition of chlorine and an ammonia compound in

specific ratios to produce predominately monochloramine, in accordance with the following simplified reactions:

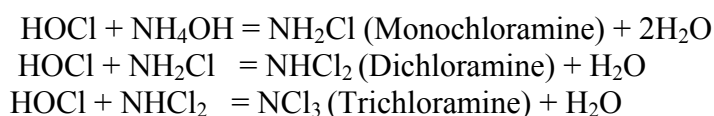

Monochloramine is formed *in situ* through the careful addition of chlorine and ammonia in the correct proportions. Large-scale application of pre-formed monochloramine is not practical. Any suitable chlorine compound may be used for chloramination. Ammonium hydroxide is normally used as an ammonia source but ammonium sulphate may be used as well. The NH_4OH will raise the pH while the $(\text{NH}_4)_2\text{SO}_4$ will reduce the pH of the water. It is also possible to apply ammonia gas, which forms NH_4OH when mixed with the water.

It is crucially important to maintain the chlorine to ammonia (as nitrogen) ratio, as measured on a mass basis at 5:1 ($\text{Cl}_2:\text{NH}_3$ as N) or 1:1 molar ratio, so that all the ammonia is converted to monochloramine and not oxidised further to di- and trichloramine, as these compounds could impart tastes and odours to the water. If the ratio is below 5:1, not all the ammonia will react to form monochloramine. If the ratio exceeds 5:1 and approaches 7,6:1, di- and trichloramine will be formed and eventually breakpoint will take place. If the ratio increases beyond 12-15:1, reaction 13 sets in and trichloramine will be formed even at high pH.

Although the sequence of chlorine and ammonia addition is not critical, the preference is to add the chlorine first so that the beneficial presence of a high chlorine concentration can be obtained, even if it is only for a short time.

Free available chlorine is a stronger oxidant and bactericide than monochloramine, but being more reactive it is rather difficult to maintain a specific free available chlorine residual for a long time. Due to its chemical properties, monochloramine is less reactive and is regarded as a bacteriostatic compound. Monochloramine concentrations can be maintained for long periods in distribution systems to control the microbiological water quality. In addition it has been found that monochloramine is more effective than free available chlorine to control biofilms in drinking water pipelines. This may be due to the neutral charge and lower reactivity of the compound, which makes it easier to penetrate biofilms, together with its preference to initially react with microorganisms rather than other chemical compounds. There is a vast difference between the relative disinfection efficiencies of free available chlorine and monochloramine. Microorganisms are killed very rapidly by free available chlorine, but it is not possible to maintain a persistent free chlorine residual and the number of microorganisms start increasing after the chlorine has been depleted. In the case of the monochloramine, the initial destruction rate of bacteria is slower, but it is possible to prevent the increase of bacteria for a longer period as the residual is more persistent.

Chloramination is used as either a primary or secondary disinfection process and is applied to produce a long lasting disinfectant residual in extended drinking water distribution systems. It has the added advantage that in contrast to free available chlorine it does not form chlorinated by products with organic matter.

Research has shown that the microbiological water quality of a distribution system deteriorates within four to five days due to an increase in microorganisms (microbiological after growth) if free chlorine alone is present. The microbiological quality in the distribution system can be maintained for up to ten or eleven days if a more persistent, longer lasting disinfectant such as monochloramine is used. Chloramination as a secondary disinfection step is ideally suited following primary breakpoint chlorination.

CHLORINE BASED COMPOUNDS THAT RELY ON THE ACTIVITY OF CHLORINE DIOXIDE (ClO₂).

Use of chlorine compounds that rely on the activity of chlorine dioxide (ClO₂)

Table B4.6: Summary of the main features of chlorine dioxide disinfection.

Method of application	Equipment required	Mechanism of action against microorganisms	Advantages / Positive aspects	Limitations/ Negative aspects
Chlorine dioxide used for water is always applied as an aqueous solution. Chlorine dioxide is generated on site by the acidification of sodium chlorate or sodium chlorite with chlorine or sulphuric acid. For large installations it is not advisable to transport chlorine dioxide because of the possibility of explosion.	The end use of chlorine dioxide could influence the feed material used. For potable water sodium chlorite and liquid chlorine is preferred. A well-controlled dosing system is required to maximise conversion of chlorite to chlorine dioxide. Storage requirements for feed chemicals need special attention as the sodium chlorite could be explosive under certain conditions.	It is possible that ClO ₂ reacts with proteins on surfaces of viruses and bacteria, and interferes with protein synthesis, thereby interrupting normal biological activity.	Does not form trihalomethane compounds (THMs). Highly soluble in water and does not react with the water itself. Not affected in pH range 6-10. Does not react with nitrogen as NH ₃ . Effective in the oxidation of chlorophenol compounds and iron and manganese. Forms an active residual. Residuals can be measured accurately. Potent bactericide.	Compounds are dangerous and must be handled with care. Chlorine dioxide gas is explosive. Reaction products of ClO ₂ are chlorite (ClO ₂ ⁻) and chlorate (ClO ₃ ⁻), which could impact on water quality. The maximum concentration of ClO ₂ that can be used will be a function of the maximum allowable concentration of ClO ₂ ⁻ in the water.

Chlorine dioxide has been used as a potable water disinfectant and oxidant since the early 1940's in Europe, America and Canada. Initially it was used purely for disinfection and the removal of iron, manganese and taste and odour causing compounds. It was later established that chlorine dioxide does not react with organic compounds to form trihalomethanes (THMs). In addition, chlorine dioxide does not react with ammonium compounds and therefore none of the oxidative power is lost in a "breakpoint" reaction as is the case with free available chlorination.

Chlorine dioxide is produced by the acidification of either sodium chlorate or sodium chlorite with a suitable acid such as hydrochloric or sulphuric acid, or by a direct reaction between chlorine and sodium chlorite. The conversion rates and efficiency of these reactions is dependent on mixing in the correct proportions and a reduced pH.

The chemical reactions of possible methods to produce chlorine dioxide for the application in water are:

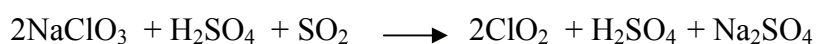
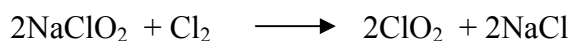

Due to the oxidation state of the chlorine atom in the chlorine dioxide molecule, it has five times the oxidative power compared to free available chlorine and is very effective as far as the oxidation of both organic and inorganic compounds is concerned.

At neutral pH, or at the pH of drinking water, chlorine dioxide is more effective as a bactericide compared to chlorine at equal dosing rates. The reason for this is that the chlorine dioxide is not affected by the pH while only 8-10% of the chlorine is available in the neutrally charged active hypochlorous acid form at pH 7,5 – 8,5.

The residual products of chlorine dioxide in water are always a chlorite or chlorate ion compared to chlorine, which is reduced to a chloride ion. The allowable concentration of these compounds in drinking water limits the concentration at which chlorine dioxide may be applied as both chlorite and chlorate may pose a health risk. There is a possible link between these compounds and methemoglobinemia and hemolytical anemia.

To protect against adverse health effects, the California Department of Health Services posed the following limitations on the concentration of the compounds on water entering a distribution system:

- **Chlorine dioxide: 0,02 mg/l**
- **Chlorite ion: 0,02 mg/l**
- **Chlorate ion: 0,2 mg/l**

Effectively this will limit the maximum concentration of chlorine dioxide that can be added to the water to 0,8 mg/l in order not to exceed the limits for the by products

OZONE

Table B4.7: Summary of the main features of ozone disinfection.

Method of application	Equipment required	Mechanism of action against microorganisms	Advantages / Positive aspects	Limitations/ Negative aspects
Ozone is poorly water soluble and equipment is specially designed to effectively transfer the ozone gas to the water phase. Counter current bubbling, turbine mixers or under induced pressure in a U-tube arrangement are used. Ozone is toxic and the gas that is not absorbed must be removed from the off gas before release to the atmosphere. This is mostly done by catalytic destruction.	Ozone must be produced on site. The most practical method of generation remains the corona-type discharge at high voltage (4000 to 30 000 volts), from dry air or oxygen.	Ozone forms free radicals, HO ₂ [•] and HO [•] , which are the reacting species. It kills bacteria through the disintegration of the cell walls.	Enhances coagulation and micro flocculation. Limits THM formation (only if chlorine is not used for final disinfection). Is a strong oxidant and destroys taste and odour causing organic compounds and oxidises inorganic compounds such as iron and manganese. Biological activated carbon (BAC) is formed on activated carbon. The action of ozone is not affected at pH 6,8 – 8,5.	Ozone is instable and no persistent residual is formed in water. Higher levels of assimilable organic carbon (AOC) compounds are formed that lead to after growth of microorganisms. End products of ozone with chlorine and bromine is chlorate and bromate. Need special equipment to determine ozone concentration in water.

The action of ozone in potable water may be classified as both an oxidant and a germicidal compound. Ozone acts as a bactericide, viricide and is a powerful oxidant in the water environment. In most installations, ozone is used primarily for taste and odour control and colour removal. In spite the fact that ozone is a very strong microbicide against a wide spectrum of microorganisms, it is necessary in most cases to add chlorine as a secondary disinfectant. This is necessary to control microbiological deterioration and after growth in distribution systems as ozone does not produce a persistent active residual.

Ozone is produced by corona discharge at voltages that vary from 4 000 to 30 000 volts (AC) (depending on the design and efficiency of the ozone generator) from dried air or oxygen according to the following reaction:

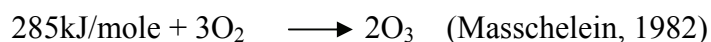

The ozone then decomposes to form the reactive free radicals:

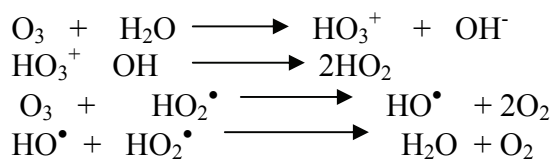

Although the free radicals have a vast oxidising power, they are short-lived and disappear very rapidly.

Ozone generators vary in size from very small (5–10 g O₃/h) to units that have capacities of 35 kg O₃/h. The quality and the amount of ozone produced is influenced by the composition of the feed gas *e.g.* moisture and oxygen content and the following physical-chemical conditions: temperature and pressure of the gas, ozone content in the gas and the efficiency by which the generator is cooled. The output of an ozone generator can also be influenced by the frequency of the power supply. In some designs changing the frequency from 50 Hz to 600 Hz can double the output. Recently, small ozone generators have been designed which are based on a solidstate generator that does not require any pre-treatment of the gas.

CONTACT TIME AND THE CT CONCEPT

The efficacy of disinfectants against microorganisms is determined by the relative oxidative power of the specific compound and the contact time in the water with the microorganism. The Ct value is the product of the concentration of the disinfectant (expressed in mg/l) and the contact time in the water (expressed in minutes). The Ct values can be calculated for any oxidising agent used as a disinfectant and for specific microorganisms if the rate at which the microorganisms are killed by the disinfectant can be determined. The contact time can be calculated from the rate at which the water is pumped and the volume of the contact chambers. It can also be measured by performing tracer studies which involves the addition of a suitable tracer at the disinfectant dosing point.

$$\begin{aligned} \text{Ct}_{\text{Disinfectant}} &= \text{Disinfectant concentration at end of contact time (mg/l)} \\ &\text{multiplied by contact time (t) in minutes,} \\ \text{Ct}_{\text{Disinfectant}} &= \text{Disinfectant mg/l} \times \text{contact time in minutes (mg.min/l)} \end{aligned}$$

The minimum Ct values required to kill different types of microorganisms are determined by exposing specific organisms to various compounds that can be used as a disinfectant. This value is not the same for all microorganisms. Differences can be attributed to the relative resistance of the microorganisms against different disinfectants *per se* and the oxidative power of the specific compound that is being used.

Ct values for the different organisms and disinfectants should be determined under practical conditions. These include temperature, pH and the chemical and physical properties of the disinfectants, which will influence efficiency.

Therefore microorganisms with little resistance against a disinfectant, such as certain bacteria and viruses, would require a shorter period or contact time, at a specific disinfectant concentration to be killed. Microorganisms with a greater resistance against a disinfectant, like protozoa, would require a greater Ct value. The required Ct value for the organism with less resistance would therefore be lower. Furthermore, a stronger disinfectant would require a shorter contact time to kill a specific organism at a certain concentration compared to a weaker disinfectant. This would also then result in a lower Ct value.

Tables B4.8, B4.9 and B4.10 give information on the Ct values (mg.min/l) to achieve 90 to 99,9% inactivation of selected organisms at 5° C at the pH indicated.

Table B4.8. Ct values to achieve 99% inactivation of micro-organisms with different disinfectants at 5° C.

Micro-organism	Disinfectant			
	Free available chlorine pH 6 to 7	Chloramine pH 8 to 9	Chlorine dioxide pH 6 to 7	Ozone pH 6 to 7
	Ct values			
<i>E.coli</i>	0,034-0,05	95-100	0,4-0,75	0,02
Polio 1 virus	1,1-2,5	768-3740	0,2-6,7	0,1-0,2
Rota virus	0,01-0,05	3806-6476	0,2-2,1	0,006-0,06
Phage f2	0,08-0,18			
<i>G lamblia</i> cysts	47->150			0,5-0,6
<i>G muris</i> cysts	30-630	1400	7,2-18,5	1,8-2,0

Ct values in the table above can also be expressed as Ct₉₉, which would indicate what disinfectant concentration would be required at a specific pH to get a 99% reduction in the number of the various organisms listed. The same applies for the values in the next two tables that contain the Ct values for *Giardia lamblia* to reach 90 and 99,9% reduction by free available chlorine.

Table B4.9. Ct values to achieve 90 % inactivation of *Giardia lamblia* with free residual chlorine at different temperatures and pH values.

Free available chlorine 2mg/l	pH	Temperature ° C			
		0,5	5	10	15
	Ct values				
6	60	40	30	20	
7	90	60	40	30	
8	130	90	60	50	
9	170	120	90	60	

Table B4.10. Ct values to achieve 99,9% inactivation of *Giardia lamblia* with free residual chlorine at different temperatures and pH values.

Free available chlorine 2mg/l	pH	Temperature ° C			
		0,5	5	10	15
	Ct values				
6	170	120	90	60	
7	260	190	130	100	
8	380	270	190	140	
9	520	370	260	190	

From the above it is clear that the relative resistance of microorganisms to different disinfectants varies according to the specific microorganisms as well as the water temperature and pH. Higher Ct values are also required to increase inactivation or destruction of microorganisms. Although the indicator organisms, including *E. coli*, and the heterotrophic plate count serve as a guideline to indicate the success of disinfection, these organisms do not necessarily have the highest resistance to disinfectants. Disinfection systems should therefore be designed such that disinfectant

concentrations and contact times are adequate to kill the more resistant microorganisms and pathogens.

Provision for contact time can be made in purposely designed contact chambers or pipelines that lead from the purification plant. If pipelines are to serve as contact chambers, the first consumer's draw off should be beyond a point where the minimum Ct value has been obtained, taking cognisance of pumping rate and water quality.

Table B4.11 gives typical Ct values for a treatment plant at locations on the plant and five kilometres away from the dosing point after breakpoint chlorination.

Table B4.11. Typical Ct values at water treatment plant and at point 5 km from the plant

	Contact time (min)	Minimum free available chlorine conc. mg/l	Maximum free available chlorine conc. mg/l	Minimum Ct value	Maximum Ct value
Point on treatment plant	3,3	0,8	2,5	2,6	8,25
Points 5 km away from plant.	67	0,8	1,2	54	80

With these high Ct values indicated in the table above, it should be possible to achieve a very high percentage compliance with respect to microbiological quality as required by the SANS 241 specification for drinking water (SABS, 2005).

RESIDUAL DISINFECTANT CONCENTRATIONS IN DISTRIBUTION SYSTEMS

It is essential that a residual disinfectant concentration be maintained up to the point where the water is consumed. This applies to all disinfectants that are used and will ensure that the water quality does not deteriorate while being pumped to the end user or stored in reservoirs. An active residual will also help to mitigate the effect of microbiological contamination. In order to estimate the required disinfectant concentration (residual) at a supply point in a distribution or reticulation system, knowledge of the disinfectant decay rate is required. This information is available for chlorine.

Chlorine decay in pipelines

Chlorine decay or depletion of chlorine during transport through pipelines is affected by a number of factors, including:

- Chlorine demand of the water
- Retention time in the pipeline and reservoir system
- Diffusion of chlorine through the water body
- Nature of the pipeline coating
- Chlorine consumed by the pipeline coatings
- Presence of foreign matter in the pipe that could exercise a chlorine demand
- Temperature
- pH of the water

The chlorine decay in pipelines can be estimated using equations that were developed based on empirical results collected from distribution systems operated under various conditions. Normally first order decay rates are used to estimate chlorine decay in pipelines.

$$C_{Cl}(t) = C_0 e^{-kt}$$

where:

$C_{Cl}(t)$ = chlorine concentration (mg/l) at time t
 C_0 = initial chlorine concentration (mg/l)
t = residence time in the reservoir

It was found that an n^{th} order decay model might describe the chlorine decay in a pipeline system better under specific conditions,

$$C(t) = \left[(k''t)(n-1) + \left(\frac{1}{C_0} \right)^{(n-1)} \right]^{\left(\frac{-1}{n-1} \right)} \text{ is more suitable.}$$

Where:

$C(t)$ = chlorine concentration (mg/l) at time t
 C_0 = initial chlorine concentration (mg/l)
t = residence time in the pipeline
 k'' = n^{th} - order decay rate constant

This equation can be used to estimate the rate of chlorine decay in long pipelines and has been used successfully to estimate the amount of chlorine required to disinfect new or re-commissioned pipelines. For the best results, the equations should be calibrated against information that has already been collected in the system being evaluated or against data from similar systems.

Chlorine decay in service reservoirs

The chlorine decay in service reservoirs is affected by similar factors as those applicable to pipelines. In reservoirs the retention time and the chlorine demand of the water play a more significant role than the nature of the structure's surface. Chlorine decay in service reservoirs is of the first order and can be determined using the following equation:

$$C_{Cl}(t) = C_0 e^{-kt}$$

where:

$C_{Cl}(t)$ = chlorine concentration (mg/l) at time t
 C_0 = initial chlorine concentration (mg/l)
t = residence time in the reservoir
k = chlorine decay rate

Typical chlorine decay rate constants that were measured in a specific system that can be used are 0,119 for a mortar lined pipeline and 0,097 for water. To obtain more reliable results the chlorine decay rate constants should be measured for the system where it will be applied.

As indicated earlier, as a result of its higher reactivity the decay rate of free available chlorine is faster than that of monochloramine. To prevent aftergrowth and to control biofilm formation in long distribution lines, it makes good sense to apply chloramination as a secondary disinfection step.

Factors that must be considered to ensure successful disinfection

A number of factors contribute to the amount of chlorine, or any other disinfectant, that must be added to water to initially achieve proper disinfection and to further maintain the microbiological water quality up to the point of consumption.

When considering the amount of a disinfectant that must be added, the following factors as a minimum should be considered. Each case is unique and the situation must be assessed, preferably continuously, to ensure that water of acceptable microbiological quality is available at point of use.

- Chemical properties of the water that is disinfected
- Chemical properties of the disinfectant
- Disinfectant demand of the water.
- pH of the water
- Temperature of the water at point of disinfectant and throughout distribution system
- Ct values that can be achieved
- Use of a secondary disinfectant
- Retention time in the distribution or reticulation system
- Disinfectant decay during distribution and storage
- Potential contamination of water in households from plumbing or after collection

From the foregoing it is clear that a certain amount of disinfectant will be lost due to various factors and that provision must be made for these losses by either adding an excess at the point of primary disinfection or by applying secondary disinfectants at pre-selected points. Frequent sampling up to the point of consumption, according to a well-designed monitoring programme, must be followed to determine the success of disinfection and to calculate the depletion of the disinfectant on an ongoing basis. The monitoring programme must include determinations for both the disinfectant concentration and microbiological quality. Provision must be made to adjust disinfectant concentration when there are rapid changes in raw water quality and possibly also during the different seasons if there is a significant difference in the seasonal water temperature or quality.

MEASUREMENT OF DISINFECTANT RESIDUALS AT A PURIFICATION PLANT AND IN A DISTRIBUTION SYSTEM

Methods to determine the concentration of chlorine based compounds and chlorine dioxide

The concentration of chlorine or any other disinfectant must be determined at the point of sampling following the correct analytical procedures. As the concentration of chemical disinfectants dissipates rapidly after a sample has been collected, samples cannot be transported to a laboratory for analysis. The analytical method used must be able to accurately measure for the specific disinfectant compound and in the case of chlorine distinguish between free available chlorine, monochloramine and total residual chlorine concentrations. Various methods are available and it must be decided which method is the most suited considering the specific circumstances. The cost of the equipment required and consumables will also influence the decision.

Accurate control of disinfectant dosages and concentrations are important to ensure effective disinfection, to minimise disinfection by product, prevent overdosing in the case of chemical compounds that may lead to offensive taste or odours and to keep costs to a minimum.

Methods that are used to determine disinfectant concentrations in water can be roughly divided into those that are based on respectively iodometric and colorimetric methods.

Iodometric methods

In this context the iodometric methods are regarded as those in which potassium iodide (KI) is added to the sample that contains the disinfectant such as chlorine and from which the iodine will then be liberated and the amount measured. The amount of iodine that is liberated from the KI is proportional to the concentration of the disinfectant present. Either hand or amperometric titrimetric methods may be used to determine the concentration of the iodine that has been liberated. To some extent the iodometric method may be regarded as an indirect method of determination and is pH dependant.

Colorimetric methods

Colorimetric determinations of disinfectants are mostly based on the use of N,N-diethyl-p phenylenediamine (DPD) as an indicator that reacts in proportion to the concentration of the disinfectant. Titrimetric or spectrophotometric methods may be used to determine the concentration of the disinfectant.

Table B4.12 below summarises the different methods that can be used to determine chlorine and chlorine dioxide concentrations in water.

Table B4.12. Summary of methods to determine disinfectant concentrations in water.

Iodometric methods

Method/Equipment	Reagents	Suitability	pH requirements
Titration with burette	KI, Sodium thiosulfate, starch as indicator	Total chlorine concentrations > 1 mg/l	Reaction is pH dependant and sample must be adjusted to pH 3-4
Amperometric titrator	KI, Phenylarsine	Differentiate between free available and combined chlorine species.	Reaction is pH dependant and sample must be adjusted to pH 6,2-6,5

Colorimetric methods

Method/Equipment	Reagents	Suitability	pH requirements
Titration with burette	DPD as indicator, KI, buffer, ferrous ammonium sulfate	Differentiate between free available and combined chlorine species. Suitable for chlorine dioxide	Reaction is pH dependant and sample must be adjusted to pH 6,2-6,5
Laboratory or handheld spectrophotometer	DPD as indicator, KI, buffer	Differentiate between free available and combined chlorine species. Suitable for chlorine dioxide	Buffer to pH 6,2 – 6,5

Amperometric titration methods are mostly suited for laboratory determinations using sophisticated equipment. Purpose designed online monitoring equipment use the same principle. This method is considered most accurate and can be used in the majority of water types with little interference from other oxidising agents, temperature variations, turbidity or colour. Loss of volatile disinfectants such as chlorine can occur because of rapid stirring in some commercial equipment. This method is suitable for the determination of both low and high concentration of oxidants.

Colorimetric methods are used effectively for laboratory and field determinations for a wide range of disinfectant species including ozone, chlorine dioxide and chlorine. Sophisticated online colorimetric equipment to determine disinfectant concentration is available. Handheld colour comparators and spectrophotometers are used to measure the relative colour intensity developed by the DPD reagent in the presence of a strong oxidant such as the disinfectant.

Hand titrimetric methods are more suited for laboratory determinations although they can also be used as a field analytical method by skilled personnel. The colorimetric DPD method is probably the most commonly used method to determine disinfectant concentrations in water, specifically chlorine, chlorine species and chlorine dioxide and to regulate their dosages. Similar methods can be used for chlorine and chlorine

dioxide because these compounds have similar physical and chemical properties. The various chlorine species can be individually distinguished with the above methods. This is of importance, especially if water with high ammonia content is disinfected (resulting in combined chlorine residuals), or chloramination is practiced (Standard Methods 19th Edition, 1995).

The DPD reagent is available in convenient packs, numbered 1 to 4 that can be used to quantify the various chlorine species as well as chlorine dioxide. The reagents in tablet or powder form contain all the reagents required to measure the oxidant concentration colorimetrically using a handheld spectrophotometer. These pre-packaged reagents are used as indicated in the table below. In all cases care must be taken not to transfer reagents from one determination to the next. The cuvettes that are used must be washed carefully between use and care must be taken not to transfer reagents from one cuvette to the next by a finger or a plug that was used to close the cuvette while mixing the contents. Table B4.13 shows the application of different DPD reagents to determine oxidant concentrations

Table B4.13. Application of different DPD reagents to determine oxidant concentrations.

Reagent number	Determination	Instruction
No 1	Free available chlorine.	Mix with water and read result immediately
No 2	No 2 reagent contains a small amount of potassium iodide, sufficient to react with monochloramine and release an equivalent amount of I ₂ that reacts with DPD.	After the recording the results obtained with reagent No 1, add reagent No2, mix, allow to stand for two minutes and record concentration of free and monochloramine
No 3	No 3 reagent contains an excess amount of potassium iodide sufficient to react with all combined chlorine and is used with reagent No 1 to measure total available chlorine.	After the recording the results obtained with reagent No 1, add reagent No 3, mix, allow to stand for two minutes and record concentration of free and residual chlorine + total available chlorine.
No 4	Reagent No 4 contains DPD and potassium iodide and is used to measure total available chlorine	Allow to stand for two minutes and measure total available chlorine.

Methods to determine the concentrations of iodine, bromine and ozone

Iodine is applied in the elemental form or is produced *in situ* by the simultaneous addition of an iodide salt and a suitable oxidant. Because of hydrolysis, active iodine exists in the form of I₂, hypiodous acid (HOI), hypiodite ion (OI⁻) or I³⁻, triiodide, in the presence of excess iodide. Most analytical methods use the oxidising power of all forms of active iodine for its determination and the results are expressed as an equivalent concentration of elemental iodine. Iodine concentrations can be determined by amperimetric titration method or with the leuco crystal violet colorimetric method (Standard Methods 19th Edition 1995).

Bromine concentrations can be determined by similar methods to those used for chlorine determinations *i.e* the amperometric titration method or with the DPD ferrous ammonium sulphate titration method.

The determination of ozone concentrations in water presents many problems due to the nature of the compound. It is rather difficult to quantify the concentration of a powerful oxidant that suffers from continuous self-destruction, off-gassing from solution and instantaneous reactions with many organic and inorganic determinants in the water.

Most of the methods used to measure ozone residuals are modifications of chlorine residual methods to determine total oxidants in solution. According to White (1992) the iodometric method is not suitable due to problems with stripping of the ozone from solution. The indigo colorimetric method is recommended as it is both accurate and simple to perform. Various types of bare electrode analysers are available that can be used to measure ozone concentrations in either the gas or the liquid phase.

CONTROL PARAMETERS (MEASUREMENT OF CHLORINE RESIDUALS)

To maintain the microbiological quality in drinking water distribution and reticulation systems it is essential that a residual chlorine concentration be present throughout the system as well as at the consumer's tap. The concentration of either free available chlorine or monochloramine at the end points is a function of the initial disinfectant (chlorine) dosage, the water quality, residence time in the distribution system and the integrity of the system. It is therefore difficult To prescribe a minimum disinfectant concentration at these points, but as a general rule the chlorine residual should not be offensive and preferably below the detection limits for sensitive individuals.

There are no general standards for chlorine residuals in drinking water. The nearest to a standard is the World Health Organisation Guideline that says that the treated water should have a free available chlorine concentration of at least 0,2 to 0,5 mg/l after a contact time of 30 minutes. Free available chlorine (hypochlorous acid and hypochlorite ion) and combined chlorine compounds (mono-, di- and trichloramine) have different chemical and physical characteristics. Free chlorine is less volatile than the combined chlorine species and therefore not easily removed by aeration. The volatility of the combined chlorine compounds progressively increases with each additional chlorine atom. Table B4.14 gives the taste and odour threshold concentrations of the respective chloramines.

Table B4.14. Taste and odour threshold for combined chlorine species

Compound	Threshold level for taste (mg/l)	Threshold level for odour (mg/l)
NH₂Cl	0,65	0,48
NHCl₂	0,15	0,13
NCl₃	0,02	0,02

According to the Australian Water Treatment Authority the threshold values are 0,6 mg/l for chlorine and 0,5 mg/l for monochloramine

Primary disinfection

In applying free available or breakpoint chlorination during primary disinfection at the purification plants, the objective is to produce a free available chlorine concentration in the water as soon as possible after chlorine addition. During the process all ammonia is oxidised to nitrogen and some chlorine compounds are formed in reactions with natural organic matter. Pipelines or contact chambers serve as contact vessels for the free available chlorine to react while the water is pumped into the distribution system or to the consumer.

Secondary disinfection

Following the breakpoint chlorination process at the purification plant, a secondary disinfection dose can be applied. For this purpose, more free available chlorine can be added to replenish the original concentration or the chlorine residual that remains at that time can be augmented by chloramination. Chloramination should be done at a point after sufficient contact with free available chlorine (or other primary disinfectant such as ozone) to capitalise on the higher bactericidal action of these compounds. If chloramination is to follow free available chlorination, special care must be taken to maintain the chlorine to ammonia ratios such that monochloramine is formed and not the higher chloramine compounds that may be responsible for taste and odours in water.

After secondary disinfection the microbiological quality in the water can be maintained effectively as the increase in bacteria due to after growth in the distribution system is prevented, owing to the prolonged bactericidal action of free available chlorine and the bacteristatic action of monochloramine. The presence of the chlorine residual would also reduce the risk of a deterioration in microbiological quality should accidental contamination of the water take place.

Tables B4.15-16 give a summary of the chlorine determinations than should be performed for monitoring purposes at various points in the treatment chain

Table B4.15. Breakpoint chlorination as primary and only disinfection process

Point where monitoring should be done.	Process	Determination and results reported as:	Additional information that can be obtained from determinations
After primary disinfection at the purification plant	Break point chlorination	Free available chlorine	Confirm that sufficient free available chlorine is present
At sampling point 2-5 km from point of primary disinfection	Break point chlorination	Free available chlorine	Confirm that sufficient free available chlorine is present
From points in the distribution system and at consumer's taps	Break point chlorination	Free available chlorine Total residual chlorine	Determine the chlorine concentration and the form in which it is present at the point of use.

Table B4.16. Breakpoint chlorination as primary disinfection followed by chloramination

Point where monitoring should be done	Process	Determination and results reported as:	Additional information that can be obtained from determinations*
After primary disinfection at purification plant	Break point chlorination	Free available chlorine	Confirm that sufficient free available chlorine is present
Sampling point 2-5 km from point of primary disinfection	Break point chlorination	Free available chlorine	Confirm that sufficient free available chlorine is present
Before secondary disinfection.	Chloramination	Total residual chlorine concentration	Determine the chlorine level prior to chloramination to set amount of chlorine and ammonia to be added.
After secondary disinfection	Chloramination	Free available chlorine. Monochloramine Dichloramine Total residual chlorine. Ammonia	Determine if all chlorine and ammonia has been converted to monochloramine and that the correct chlorine: ammonia ratio has been maintained.
From points in the distribution system	Chloramination	Free available chlorine Monochloramine Total residual chlorine Ammonia	Determine the chlorine concentration and the form in which it is present at the point of transfer to local authority to determine the success of chloramination

* The same approach would apply where a different compound that does not produce a residual, such as ozone, is used as primary disinfectant.

DISINFECTION BY-PRODUCTS

Disinfection byproducts are organic compounds produced as an undesirable side effect of drinking water disinfection and oxidation. The compounds of greatest concern usually contain chlorine and/or bromine atoms. Some of these compounds have been classed as suspected mutagens and/or carcinogens and several have been found to cause adverse reproductive or development effects in animal studies.

Chemical oxidants used as disinfectants do not react exclusively with microorganisms and many side reactions may take place with abiotic dissolved organic matter. Most of the oxidant/disinfectant demand can be attributed to reactions with such abiotic molecules in the water. The reaction products of these interactions include reduced forms of the oxidants (*e.g.* chloride, hydroxide, chlorite, chlorate) and oxidised forms of the organic and inorganic reactants.

Compounds consisting of natural organic matter (NOM) are often attacked at the carbon-carbon double bonds and the organic byproducts formed are highly oxidised. These products often contain oxygen atoms and are fragmented products containing

one to four carbon atoms. Specific examples are oxalic acid, aldehydes, acetic acid and formic acid.

A number of the disinfectants are capable of producing byproducts that have halogen atoms (*i.e.* chlorine, bromine and iodine) incorporated into their structure. Aqueous chlorine and bromine will do this to the greatest extent, followed by chloramines and ozone.

Reaction time, disinfectant dose and pH, in addition to the type and concentration of the natural organic matter, influence the nature of the disinfection byproducts formed.

Chlorination byproducts

Chlorination byproducts include a wide range of halogenated and non-halogenated organic compounds such as the trihalomethanes (THMs), haloacetic acids (HAAs) and haloacetonitriles. They are generally small, highly substituted end products of the reaction of chlorine with organic matter. In water with low bromine levels the exclusively chlorine-substituted forms will predominate (*e.g.* chloroform, di- and trichloroacetic acid). In water with moderate to high concentrations of bromine, compounds with higher levels of bromine substitution will form (*e.g.* bromodichloromethane, dibromochloromethane and bromodichloroacetic acid).

It is possible that the concentration of HAAs in water has been underestimated but these compounds are always present when THMs are present.

Total halogenated organic compounds (TOX) are one of the end products of chlorination and trihalomethanes and haloacetic acids may comprise approximately fifty percent of these compounds.

The maximum allowable concentration of THMs in drinking water in South Africa is 100 µg/l, which is in line with the Environmental Protection Agency (EPA) specifications but much higher than the European Union (EU) guideline of 1µg/l.

Chloramine byproducts

Monochloramine is less reactive towards organic compounds than free available chlorine. Low concentrations of products such as dichloroacetic acid, cyanogen chloride, chloroform and trichloroacetic acid may form. These compounds may also be produced in the presence of low concentrations of chlorine.

Chlorine dioxide by-products

Chlorine dioxide undergoes a variety of oxidation reactions with organic matter to form oxidised organics and chlorite. The concentration of the chlorite amounts to between 50 and 70% of the amount of chlorine dioxide consumed. Chlorate may also be formed by disproportionation of chlorine dioxide. All three the oxidised chlorine species *i.e.* chlorine dioxide, chlorite and chlorate are considered to have adverse health effects and their presence in drinking water is a cause for concern.

Chlorine dioxide can undergo a limited number of chlorine substitution reactions to form chlorinated aromatic compounds, but trihalomethanes have never been detected as a reaction by-product.

Ozone byproducts

Ozone can lead to the formation of brominated byproducts when applied to water that contains moderate to high levels of bromine. This is a direct result of ozone's ability to oxidise bromine to hypobromous acid and related species. Some of this oxidised bromine will continue to react to form the bromate ion. Much of the remaining hypobromous acid will react with natural organic matter to form a variety of brominated organic compounds. These are similar to the halogenated byproducts formed with chlorine *viz.* THMs such as bromoform and HAAs like dibromoacetic acid.

The oxidation of organic material by ozone and the breakdown of long chain organic molecules results in the formation of smaller molecules that are more readily assimilated by microorganisms, which gives rise to the terms assimilable organic carbon (AOC) or biodegradable organic matter (BOM). These compounds are not necessarily deleterious to water quality but may give rise to excessive microbiological growth if an adequate disinfectant residual is not maintained.

The formation of AOC and increased microbiological activity may also be encouraged by the addition of ozone prior to granular activated carbon (GAC) contact. It will then act as biologically activated carbon (BAC) which enhances the removal of organic compounds and increases the periods between which reactivation of the GAC is required.

Control of disinfection byproducts formation

Effective disinfectant byproduct control is usually undertaken by regulating the presence and concentration of precursor compounds in the water. This includes avoiding treatment of any contaminated water, as humic and fulvic acids are commonly found in treated sewage effluent and industrial effluents may contain bromine. The organic precursor compounds that are present can be removed by a specific treatment such as adsorption onto activated carbon.

Care must also be taken not to add any undesirable or potentially harmful compounds that may be present in a contaminated disinfectant. An example is sodium hypochlorite that may contain high concentrations of chlorate ion.

Chlorine dosing equipment

The design of chlorine handling and dosing facilities, especially where liquid chlorine is being considered, is highly specialised and should not be underestimated. A poor design can put the health and lives of operating personnel at risk and also affect the functioning of the chlorine dosing facility. The conventional chlorination facility for use in potable water treatment consists of three elements, namely chlorine source, metering system and injection system.

The design for handling and dosing of sodium hypochlorite solution or powdered calcium hypochlorite is relative simple compared to that of liquid or gaseous chlorine. Some aspects are common to all three, such as the requirement for proper mixing and contact with the water.

Selection of the chlorine compound to be used

The liquid or solid hypochlorite products are normally applied at relatively small water purification plants and their use at larger installations is usually only for very specific purposes. If the capacity of a treatment plant warrants the installation and use of liquid chlorine, then the remoteness and locality of the purification plant should not be a deterring factor. Not only is the cost of liquid chlorine (expressed per mass of active compound) less than that of the hypochlorite products, the former also has advantages such as:

- Some systems where chlorine gas is dosed do not require electrical power to operate as the chlorine is drawn off directly from a 68 kg container in the gaseous form.
- Chlorine may be withdrawn in either the gaseous or liquid form from one ton cylinders. For this purpose these containers are fitted with two valves. If the cylinder is placed such that the outlets are vertically above each other position gaseous chlorine can be withdrawn from the topmost valve and liquid from the bottom outlet.
- The shelf life of sodium hypochlorite products in solution is relatively short. Sodium hypochlorite is normally supplied at a concentration of 15% mass by volume, but depending on the storage temperature may lose about 6,5 % of the original concentration within four weeks at 15°C and as much as 37 % of the original concentration within four weeks at 30°C.
- Onsite electrolytic generation of sodium hypochlorite is a practical way of overcoming many of the problems associated with the depletion of chlorine concentration from hypochlorite solutions during prolonged storage. In these systems sodium chloride is used as the feedstock to produce a sodium hypochlorite solution of about 5 % mass by volume. By using this chlorine solution it is possible to manage the persistent loss in chlorine concentration because a lower initial chlorine concentration is used and in general the storage period is short. Calcium hypochlorite in solid form is available as granules, tablets and briquettes. Suitable dosing equipment to suit each of these forms is available.
- Any contact between hypochlorite solutions or solids and metals such as iron, nickel, cobalt and copper must be avoided. The presence of these metals can greatly reduce the stability of the hypochlorite compounds, especially the solutions, as these metals act as powerful catalysts in the decomposition of hypochlorites.
- All chlorine-dosing systems, irrespective of the chlorine compound or the type of dosing equipment selected, require regular maintenance. Typical problems include the blockage of small-bore sodium hypochlorite dosing lines and corrosion of chlorinators or equipment that comes into contact with chlorine compounds or vapours.

Handling of chlorine compounds

All chlorine compounds are strong oxidants and corrosive in nature. Dry chlorine gas is chemically very reactive but not excessively corrosive. However, once chlorine gas has reacted with water, including moisture in the atmosphere, very corrosive hydrochloric acid is formed. Therefore the correct materials of construction must be selected at all sites where chlorine is handled or stored.

Chlorine compounds must never be stored together with organic material such as oil or grease, nor with flammables such diesel, paraffin or petrol.

To avoid rapid decomposition, hypochlorite solutions must be kept at the lowest possible temperatures and exposure to direct sunlight must be avoided.

Liquid chlorine containers must also be stored at the lowest practical temperature and away from any external heat source, including direct sunlight. If the chlorine containers are exposed to high temperatures the chlorine will expand and eventually cause the container to rupture should the temperature rise too high. However, if chlorine containers are kept at temperatures of 10°C or less the flow of chlorine will be sluggish and erratic. Ideally they should be stored and used at between 18°C and 25°C with this temperature being lower than the chlorinator to avoid condensation in the chlorinator.

The maximum chlorine abstraction rates of chlorine gas or liquid from containers must be observed at all times. The maximum respective withdrawal rates are 1,3 kg/hour for 68kg cylinders and 9,0 kg/hour from one ton drums.

Safety precautions when handling chlorine compounds

All the chlorine compounds used in water purification are highly toxic. These include pure chlorine in the liquid or gaseous form as well as liquid sodium hypochlorite and solid calcium hypochlorite.

When handling chlorine all necessary precautions must be taken and the required personal protective equipment must be worn at all times when working with connections to chlorine containers. Accidental spills or leaks must be contained and cleaned up using recommended methods in accordance with legal and safety requirements. The suppliers of chlorine products and chlorine dosing equipment can provide information on the safe handling of chlorine products and equipment.

CHAPTER B5: STABILISATION

Richard Loewenthal

INTRODUCTION

Water sources for municipal supplies range over a broad spectrum of chemical quality. At the one end are waters having virtually no dissolved salts, with low alkalinity and low pH; examples occur to a lesser or greater extent in virtually all countries worldwide, but in South Africa principally along eastern seaboard regions. At the other end of the spectrum, are waters with high concentrations of dissolved salts, high alkalinity and variable pH and in addition, for underground waters, high concentrations of dissolved iron, manganese and possibly carbon dioxide. Between these extremes, waters may be found with virtually any combination of chemical quality reflecting the history of the water and the region from which it is derived.

Most waters require some form of treatment before discharge to a distribution system. The chemical quality of the water entering the distribution system always has some impact on the system: Waters with appropriate qualities have minimal impact and the systems have long life expectation; waters with inappropriate qualities can have a major impact and reduce expectation of the lives of systems substantially. Impact of such waters on distribution systems divides into three types:

- The water may cause extensive precipitation of calcium and iron minerals on the walls of the conduits, so extensive that the carrying capacity of the conduit may be reduced severely, to zero on occasion. This effect is designated by the term *fouling*.
- The water may dissolve away cement material comprising the conduits and retaining structures, causing destruction of the integrity of the material. This effect is designated by the term *aggression*.
- Electro-chemical reactions between the water and metal components of the system may give rise to dissolution of the metal and precipitation of metal salts, resulting in pitting, nodule formation, red water, etc. Destruction of the conduit and loss of function are the end results. These effects are designated by the term *corrosion*.

Economic costs in maintaining distribution systems have not been estimated countrywide in South Africa, but must be substantial - this is probably the case in most countries worldwide. Studies in this regard are long overdue, but qualitative discussions with municipal officials in charge of water supplies and with consumers, have forced the conclusion that problems with corrosion and aggression in water distribution systems are indeed widespread. In many instances, but not in all, these effects can be nullified or minimised by relatively simple corrective chemical treatment of the water. Such treatment is termed *stabilisation*. Appropriate stabilisation, however, demands an understanding of the underlying chemistry of the water and the interactions between the water and the material of the retaining structure.

Extensive research has been conducted into the chemistry of water in the treatment of water supplies for municipal use. Perhaps the most influential contribution has been that of Langelier (1936) in both recognising the importance of the carbonate weak acid system in establishing pH in water, and the solubility of calcium carbonate

mineral as an important consideration in stabilisation. He proposed that water be treated to a state of oversaturation with respect to calcium carbonate, so that a protective film formed on pipe walls. To assess the saturation state, he developed a qualitative index, the Langelier Saturation Index (LSI) based on equilibrium chemistry in terms of the calcium and alkalinity concentrations, and pH. He proposed criteria in terms of this index to prevent aggression and corrosion.

Although more than 60 years have past since the pioneering work of Langelier, his criteria are still applied, in many instances indiscriminately. Since Langelier's work, extensive research studies have been affected on the chemistry of water and the chemical responses of water in contact with iron metals and cement materials. The influence of other factors, such as chloride and sulphate ions, dissolved oxygen concentration, velocity of flow, etc. have been more clearly delineated, though by no means resolved. This is true, in particular, with regard to corrosion.

In this chapter, the currently accepted criteria used in South Africa for preventing corrosion and aggression in drinking water distribution systems are set out. The problem(s) associated with attaining these criteria via chemical treatment and judicious pipe material use are highlighted. In this regard, the problem of rapidly assessing the stability of a water in a quantitative fashion, is addressed using the computer software STASOFT 4. Examples of particular application are addressed. These include:

- Stabilisation of low calcium/low alkalinity, acidic waters (typical coastal waters of South Africa)
- Stabilisation of high calcium, carbon dioxide supercharged underground waters
- Stabilisation of typical South African inland waters
- Determining the effects of temperature on the stability of distribution waters
- Post-softening stabilisation
- Water blending

Although use of STASOFT does not require explicit understanding of the chemistry underlying the computational algorithms, it is instructive to the reader to have an overview of this chemistry –consequently a brief discussion also is given in this regard.

QUALITY CRITERIA FOR STABILISATION

Criteria for prevention of aggression

Aggression is the designation given to the phenomena where water contained in cement and concrete lined structures attacks the cement matrix. Two distinct aggressive processes have been identified: (1) The water has chemical characteristics that cause dissolution of some of the minerals in the cement matrix. (2) The water contains sulphate species which may react chemically with some of the minerals in the cement matrix to form products that cause physical disruption of the matrix.

With regard to (1) chemical dissolution, at the outer surface of the cement body, the free lime $[\text{Ca}(\text{OH})_2]$ will react with carbonate species in the water to form a calcium carbonate (CaCO_3) precipitate. If the chemical characteristic of the water is such that it causes dissolution of CaCO_3 , this mineral will be removed from the cement matrix. This exposes “fresh” free lime to reaction, and, in this fashion the aggression

progressively penetrates deeper into the concrete mass, weakening the matrix strength and exposing any steel reinforcing to the elements. This form of aggression can be prevented by changing the chemical characteristics of the water, such that it will not dissolve CaCO_3 in the cement matrix, i.e. the water is changed to be supersaturated with respect to CaCO_3 and, in effect, has a potential for CaCO_3 precipitation (see below). Exactly what this CaCO_3 precipitation potential should be cannot be stated unequivocally, one can only refer to distribution systems that have operated successfully. In this regard, a precipitation potential of about 4mg/l CaCO_3 appears acceptable.

With regard to (2) sulphate attack, when the dissolved sulphate concentration is high, the hydrated calcium oxide, alluminates and allumino ferrite react with sulphate species to form sulphate minerals that occupy greater volumes than the original minerals, causing expansion and consequent physical disintegration of the cement matrix. Furthermore, hydrated calcium silicate also reacts with sulphate ions forming a product which has much lower strength than the original mineral.

The considerations above lead to two guidelines for the prevention of aggression:

Guideline 1: The chemical state of the water needs to be adjusted to a state of slight supersaturation with respect to CaCO_3 ; a precipitation potential of about 4mg/l is recommended.

Guideline 2: For waters with sulphate content in excess of 350mg/l (as SO_4), the cement material used in the conduit should have a tricalcium alluminate content of less than 5.5%.

Criteria for prevention of corrosion of iron piping

Corrosion of metal components of pipes carrying water is a result of redox reactions at sites on the metal-water interface, by the formation of electrochemical cells each with an anodic and cathodic area. At the anode, metal molecules lose electrons to form metal ions that pass into solution; at the cathode, the electrons pass to some electron acceptor (usually oxygen) in the water adjacent to the cathode. These reactions induce significant changes in the chemical composition of the water adjacent to the anodic and cathodic areas. Depending on the circumstances, the reactions may cause continuous ionisation of the metal at the anode (corrosion) or may give rise to precipitation of minerals over the anode and cathode thereby reducing the areas of active electrochemical sites and hence reducing the rates of overall reactions, eventually stopping the corrosion completely (passivation of the surface).

Variables in the bulk water affecting the corrosion rate and passivation include:

- (i) CaCO_3 precipitation potential,
- (ii) pH buffering capacity
- (iii) chloride and sulphate concentrations,
- (iv) velocity of flow and
- (v) concentration of dissolved oxygen.

Loewenthal *et al.* (1986) give a critical review as to how these factors affect the corrosion/passivation of metal surfaces. A brief summary and guidelines as to quality criteria are given below.

For waters “low” in dissolved chlorides and sulphates, the anodic reaction rate (i.e. the rate of metal ions going into solution) is a prime factor as to whether a passivating precipitate film of any or all of the oxides Fe_2O_3 or FeOOH or Fe_3O_4 will form or not. For waters “higher” in chlorides and sulphates, the formation of a protective film is adversely affected by these ions and requires special consideration. The overall corrosion rate always is governed by the slower of the anodic and cathodic reactions, because the rates of these two half reactions must be equal. For a new pipe, initially the overall reaction rate is high. Interactively, this causes changes in the chemical condition of the water layer next to the metal at both the anode and cathode. At the cathode, initially, positively charged colloidal CaCO_3 will form a precipitate cover, if the bulk chemical conditions are appropriate. This precipitate, which is porous to some degree, reduces the rate of ionic and molecular diffusion to the surface. While the overall reaction rate is still high, the rate is controlled by the diffusion rate at the cathode. At this stage the film that forms at the anode has no effect on the reaction rate, because the reaction products that form are readily permeable and do not isolate the metal. If at the cathodes the corrosion rate is reduced sufficiently by diffusion affects, then at the anode the reactions (formation of protective oxides) can reach completion, forming an impervious film and thereby reducing the anodic area so that eventually the corrosion rate becomes controlled by the anodic reaction. In time, the whole anode is covered by the impervious oxide film giving rise to passivation. The considerations above give rise to the following guidelines:

Guideline 1: The bulk water should be saturated or slightly supersaturated with respect to CaCO_3 (where cement type pipes form part of the distribution system, the criteria covering non-aggression for cement material will automatically satisfy this criterion for metal pipes).

Guideline 2: Calcium and alkalinity values should not be less than about 50mg/l (expressed as CaCO_3). This is to ensure that sufficient cathodic carbonate film is deposited.

Guideline 3: The presence of chlorides and sulphates in water tends to sustain corrosion by preventing oxide film formation. Bicarbonate and carbonate ions tend to ameliorate the adverse affects of chlorides and sulphates. However, these affects have not yet been clearly delineated in a quantitative fashion. Consequently, Larson (1955) concluded that provided the ratio (with all species expressed as equivalents) (chlorides + sulphates)/alkalinity is less than 0.2, then the deleterious affects on passivation due to these anions will be minimal. This guideline has relatively little value in South Africa, because so many of the inland waters exceed the given ratio. Therefore the criterion of the Water Research Centre (1981) is of greater utility. They suggest that waters be regarded as potentially corrosive when either the chloride or sulphate concentration exceeds 50mg/l. Clearly, the higher the chlorides and sulphates are above this limit, the greater should be the consideration given to substituting metal conduits with conduits of cement type or plastic material, or metal pipes must be lined internally with cement or some other inert coating material.

Guideline 4: Even if guidelines 1-3 above are satisfied, should the velocity of flow be low in the pipe, corrosion can still continue to occur due to oxygen diffusion limitations at the liquid/metal interface. Exactly what the minimum velocity should be, cannot be determined unequivocally, but velocities less than *ca.* 0.2 m/s are to be avoided and flow velocities of greater than 1 m/s are to be preferred. Clearly any design feature that would give rise to dead ends in the system should also be avoided. Where low flow velocities are unavoidable in the system, the conduits should be made from cement type or plastic materials.

Guideline 5: The dissolved oxygen concentration in the water should be greater than 4 mg/l (as O₂). Dissolved oxygen plays a vital role in corrosion and passivation. With low concentrations of dissolved oxygen in the bulk solution it has been shown that a protective oxide film cannot form over the anode, and corrosion continues. It is not possible to determine the lower level of oxygen concentration above which corrosion and passivation are independent of oxygen concentration; this will depend on flow velocity, alkalinity and calcium concentrations, and other factors.

BASIC CHEMISTRY OF STABILISATION

Examining the criteria listed above for the prevention of aggression, corrosion and fouling in drinking water systems, it is evident that either or both of two procedures can be adopted. First, the chemical characteristics of the water can be modified via chemical dosing (stabilisation) to attain the desired quality criteria – for example, adjusting pH, alkalinity and calcium concentration, CaCO₃ precipitation potential, etc. Second, via judicious use of materials in the distribution network system – for example, high concentrations of Cl⁻ and SO₄²⁻ species preclude the use of iron pipes and fittings in direct contact with the water. In this event, iron pipes are either lined or non-metallic material used.

This paper principally considers resolving problems via chemical treatment, i.e. stabilisation. Before dealing with specific examples, it is necessary first to review briefly the chemistry underlying characterization and pH control in natural terrestrial waters, and algorithms for determining both change in state and CaCO₃ precipitation potential.

Characterization of the aqueous phase

When evaluating a water source to be utilized for drinking water purposes, the first problem facing the water treatment authority is assessing whether the water needs to be stabilised prior to distribution. This implies that the aqueous phase species concentrations must be determined from some set of measurements; such measurements and determinations are termed characterization. The aqueous phase species concentrations of importance in drinking water distribution (excluding Ca²⁺ for the moment) are the carbonate species (H₂CO₃, HCO₃⁻ and CO₃²⁻) and the water species (H⁺ and OH⁻); in terrestrial waters, the carbonate weak acid is dominant and controls the pH. Of the aqueous phase species, the most obvious and “simple” measurement to make is that of H⁺, via pH. The concentrations of the other species can be linked to pH via equilibrium chemistry, as follows:

$$\frac{(H^+)[HCO_3^-]}{[H_2CO_3^*]} = \frac{K_1}{f_m} = K_1' \quad (1)$$

$$\frac{(H^+)[CO_3^{2-}]}{[HCO_3^-]} = \frac{K_2 f_m}{f_d} = K_2' \quad (2)$$

$$(H^+)[OH^-] = K_w / f_m = K_w' \quad (3)$$

where:

- K_1, K_2 and K_w = temperature dependent equilibrium constants, the values of which are well defined (see Appendix A).
 f_m and f_d = mono- and divalent activity coefficients, the values of which can be determined from the Davis equation and the ionic strength of the water (see Appendix A).
 (X) = activity of species X.
 $[X]$ = molarity of species X.

These three equations are in terms of the five system parameters (weak acid species concentrations), i.e. we have two more unknowns than equations. Consequently, values need to be known or measured for two of the five system parameters in order to characterize the aqueous phase. However, in practise only the H^+ concentration can be measured directly, via pH. This problem is resolved by introducing a set of state parameters (called capacity parameters) which (perhaps) can be easily measured (for example, the various forms of alkalinity and acidity and total weak acid species concentration), each of which can be expressed in terms of the five system parameters. However, even by introducing capacity parameters, the basic problem of having two more unknowns than equations remains. This can be resolved if one of the new capacity parameters can be measured directly. For example, considering the capacity parameter alkalinity and selecting $H_2CO_3^*$ as reference species:

$$\text{Alkalinity} = 2[CO_3^{2-}] + [HCO_3^-] + [OH^-] - [H^+] \quad (4)$$

And, for acidity selecting CO_3^{2-} as reference species:

$$\text{Acidity} = 2[H_2CO_3^*] + [HCO_3^-] - [OH^-] + [H^+] \quad (5)$$

Normally the two parameters most easily and accurately measured in characterization are pH and Alkalinity; however, Acidity becomes extremely useful in considering determination of change in state, as shown below. By measuring Alkalinity and pH of the water, all the carbonate and water species concentrations (and other capacity parameters) can be determined (via Eqs. (1) to (5)), and the water completely characterised.

Algorithm for change in aqueous state with dosing

The individual species concentrations (including pH) change in a complex fashion with chemical dosing (or any other perturbation). However, the values of the Alkalinity and Acidity capacity parameters change in a simple stoichiometric fashion:

$$\Delta\text{Alkalinity} = 2[\text{CO}_3^{2-}]_a + [\text{HCO}_3^-]_a + [\text{OH}^-]_a - [\text{H}^+]_a \quad (6)$$

$$\Delta\text{Acidity} = 2[\text{H}_2\text{CO}_3^*]_a + [\text{HCO}_3^-]_a - [\text{OH}^-]_a + [\text{H}^+]_a \quad (7)$$

where:

subscript 'a' = added

This observation forms the basis for determining change in state with dosing. The steps involved in the algorithm are as follows:

- (i) Characterize initial state (including determination of Acidity) from pH and Alkalinity measured using Eqs. (1) to (5), as described above.
- (ii) Determine changes in Alkalinity and Acidity with dosing from Eqs. (6) and (7).
- (iii) Determine final Alkalinity and Acidity as:
 Alkalinity (final) = Alkalinity (initial) + $\Delta\text{Alkalinity}$
 Acidity (final) = Acidity (initial) + $\Delta\text{Acidity}$
- (iv) Characterize the final state (including determination of final pH) from the known values for Alkalinity and Acidity after dosing (i.e. (iii) above) using Eqs. (1) to (5).

Aqueous phase-solid CaCO_3 equilibrium and saturation state

If a particular water is known also to be in equilibrium with solid CaCO_3 (normally this is not known), then an extra equilibrium equation describing this two phase state is the solubility product equation:

$$[\text{Ca}^{2+}][\text{CO}_3^{2-}] = K_{\text{sp}}/f_d^2 = K'_{\text{sp}} \quad (8)$$

where:

$K_{\text{sp}}, K'_{\text{sp}}$ = thermodynamic and apparent solubility product constants for CaCO_3 (see Appendix A).

Thus, for a water in equilibrium with solid CaCO_3 , all the equilibrium relationships (Eqs. (1) to (3) and Eq. (8)) must be simultaneously satisfied. Again it is evident that there are two more unknowns than equations, and again values for two parameters (e.g. pH and Alkalinity) must be measured to characterize the water. It is important to note that, in this case, determination of Ca^{2+} from Eq. (8) can only be effected ***provided it is known that solid-aqueous phase equilibrium has been established***. If this is known to exist the water is termed “just saturated” with respect to CaCO_3 . However, if the product is greater than K'_{sp} the water is “over saturated” or “supersaturated” with respect to CaCO_3 and slowly with time CaCO_3 will precipitate until saturation is attained. If the product is less than K'_{sp} the water is “undersaturated” with respect to CaCO_3 and dissolution of the solid phase will occur.

CaCO₃ precipitation potential

The LSI provides a relative assessment of the saturation state of a water. However, this assessment is qualitative only, in that it does not quantify the actual amount of mineral that will precipitate if the water attains saturation equilibrium. In contrast, the CaCO₃ precipitation potential (CCPP) is a parameter that quantifies the mass of CaCO₃ which will precipitate (dissolve) to bring the solution to saturation. Although inextricably linked with stabilisation, a major drawback in its use has been difficulties arising both in its determination from some set of measurements effected on the water, and in determining chemical dosages to be applied to obtain a water with a prescribed CCPP. However, with the availability of personal computers this problem has been bypassed either by using computer graphics – that is the so-called Modified Caldwell Lawrence type diagram (Loewenthal and Marais, 1976) – or with interactive computer programs specifically developed for water treatment. Both these approaches use a common algorithm for determining CCPP. In the previous section it was shown that *at saturation* only two weak acid system parameters need to be measured (known). However, if the saturation state is unknown and to be determined, then Ca²⁺ and two other parameters to characterize the carbonate weak acid system need to be known. Consequently, if two parameters can be identified the values for which do not change with CaCO₃ precipitation/dissolution, then the values of these two parameters supply sufficient information to characterize the final saturation state. These two parameters are Acidity and (Alkalinity – 2[Ca²⁺]) – all species concentrations on the molar scale; from their values in the raw water and using the equilibrium relationships (Eqs. (1) to (8)), the Ca²⁺ and Alkalinity values at saturation are determined. The CCPP is then determined as either the change in Ca²⁺ concentration or twice the change in Alkalinity between initial and saturated (final) states.

CONTROL OF STABILISATION PRACTICE

From the standpoint of a water treatment authority, stabilisation encompasses solution to a myriad of problems. These may vary from a water source whose quality varies stochastically, to addressing gross changes in quality in the treatment facility itself, to changes of (for example) temperature in the water during distribution. To date no means has been made available to the engineer/chemist for addressing these problems in a rapid and practical fashion. It was for this reason that the computer software STASOFT 4 has been developed (Morrison and Loewenthal, 2000). Some examples of its utility are given below. Although all the examples are drawn from the scenario in South Africa, application is universal.

Examples for stabilisation and pH control using STASOFT 4

The computer software STASOFT 4 explicitly addresses a number of tasks that may arise in water treatment, *inter alia* pH control and stabilisation. The program determines and displays the sequential changes in state of a water resulting from the application of a series of treatment processes, or from changes in the state of the water. Some examples are presented below:

Example B5.1: Stabilisation of soft acidic waters of eastern coastal regions

Analysis of a water after colour removal gives pH = 5.75, Ca = 1.5mg/l (as Ca), Alkalinity 1.5 mg/l (as CaCO₃), Cl⁻ ~ 2 mg/l, SO₄²⁻ ~ 3 mg/l, conductivity = 10mS/m and temperature = 20°C. Determine both the (i) lime [Ca(OH)₂] and (ii) CO₂ requirements to stabilise the water, and the (iii) effects of chlorination using calcium hypochlorite [Ca(OCl)₂] (4.0 mg/l). A printout of the screen from the program showing the raw water quality and the effect of sequential addition of Ca(OH)₂, CO₂ and Ca(OCl)₂ is given in Fig. B5.1.

The screenshot shows the STASOFT 4 software interface. The window title is 'StaSoft4 File: C:\MyFiles\MyFilesG-P\Papers\Stabilisation\Example1.ss'. The main content area displays a table of water quality parameters before and after the sequential addition of Ca(OH)₂, CO₂, and Ca(OCl)₂. The table is organized into sections: 'TREATMENT PROCESS' and 'PARAMETERS (mostly mg/l)'. The 'TREATMENT PROCESS' section shows the initial water quality and the amount of each chemical added. The 'PARAMETERS' section shows the resulting water quality after each step.

NAME: Stabilisation of soft acid water					
TREATMENT PROCESS:					
	Initial	Ca(OH) ₂	CO ₂	Ca(OCl) ₂	
Unit:	Water	mg/l	mg/l	mg/l	
Purity of Process Chemical:		100.0%	100.0%	35.0%	
Amount:		29.0	26.0	4.0	
PARAMETERS (mostly mg/l)					
Temperature	C	20	20	20	20
Conductivity	mS/m	10	17	17	17
Calcium, dissolved	Ca	1.5	17.2	17.2	18.8
Tot Chlorine Species	Cl	0.00	0.00	0.00	1.40
pH		5.75	10.85	9.04	9.04
Alkalinity	CaCO ₃	1.5	40.7	40.7	42.7
Acidity	CaCO ₃	14.7	-24.5	34.7	34.7
Carbonic Species	CO ₂	7.1	7.1	33.1	33.1
CaCO ₃ PP	CaCO ₃	-17.5	13.2	4.1	4.4

Figure B5.1: Printout of the screen of STASOFT 4 for Example 1, showing the raw water data and the effects of sequential addition of Ca(OH)₂, CO₂ and Ca(OCl)₂.

Example B5.2: Stabilisation of typical South African inland water (Gauteng region)

Analysis of a South African inland water (from the Gauteng region) gives pH = 7.65, Alkalinity = 80 mg/l as CaCO₃, Ca = 26 mg/l (as Ca), conductivity 60mS/m and temperature = 20°C. Determine the lime dose (Ca(OH)₂) to effect a Ca precipitation potential of about 4 mg/l (as CaCO₃).

A printout of the screen from the program showing the raw water quality and the effect of sequential lime dosages is given in Fig. B5.2. A comparison between dosing with lime (Ca(OH)₂) and sodium carbonate (Na₂CO₃) is shown in Fig. B5.3.

NAME: GAUTENG: Sequential dosages

TREATMENT PROCESS:	Initial	Ca(OH) ₂	Ca(OH) ₂	Ca(OH) ₂	Ca(OH) ₂
Unit:	Water	mg/l	mg/l	mg/l	mg/l
Purity of Process Chemical:		100.0%	100.0%	100.0%	100.0%
Amount:		2.0	2.0	2.0	1.0

PARAMETERS (mostly mg/l)

Parameter	Unit	Initial	Ca(OH) ₂	Ca(OH) ₂	Ca(OH) ₂	Ca(OH) ₂
Temperature	C	20	20	20	20	20
Conductivity	mS/m	12	12	13	13	14
Calcium, dissolved	Ca	20.0	21.1	22.2	23.2	23.8
pH		7.40	7.56	7.78	8.11	8.32
Alkalinity	CaCO ₃	100.0	102.7	105.4	108.1	109.5
Acidity	CaCO ₃	117.7	115.0	112.3	109.6	108.2
Carbonic Species	CO ₂	95.7	95.7	95.7	95.7	95.7
CaCO ₃ PP	CaCO ₃	-12.9	-8.0	-3.0	1.9	4.4

Page: 3 Modified

Figure B5.2: Printout of the screen of STASOFT 4 for Example B5.2, showing the raw water data and the effects of sequential addition of Ca(OH)₂, to estimate the Ca(OH)₂ dose to effect a positive CaCO₃ precipitation potential of ~ 4 mg/l (as CaCO₃).

NAME: GAUTENG: Comparing stabilization dosage types on a single screen

TREATMENT PROCESS:	Initial	Ca(OH) ₂	Ca(OH) ₂	Na ₂ CO ₃
Unit:	Water	mg/l	mg/l	mg/l
Purity of Process Chemical:		70.0%	70.0%	100.0%
Amount:		5.5	-5.5	11.2

PARAMETERS (mostly mg/l)

Parameter	Unit	Initial	Ca(OH) ₂	Ca(OH) ₂	Na ₂ CO ₃
Temperature	C	20	20	20	20
Conductivity	mS/m	60	61	60	61
Total Dissolved Solids		400	406	400	408
Calcium, dissolved	Ca	26.0	28.1	26.0	26.0
pH		7.65	8.49	7.65	8.50
Alkalinity	CaCO ₃	80.0	85.2	80.0	90.6
Acidity	CaCO ₃	87.1	81.9	87.1	87.1
Carbonic Species	CO ₂	73.5	73.5	73.5	78.1
CaCO ₃ PP	CaCO ₃	-5.9	3.9	-5.9	4.1

Page: 1 Modified Select a parameter

Figure B5.3: Printout of the screen of STASOFT 4 for Example B5.2, showing the raw water data and the use of the different dosage chemical types Ca(OH)₂ and Na₂CO₃, to estimate the dose to effect a positive CaCO₃ precipitation potential of ~ 4 mg/l (as CaCO₃).

Example B5.3: Effects of heating and exchange of CO₂ with the air on a hard water.

Analysis of a groundwater gives pH = 7.40, Alkalinity = 165 mg/l as CaCO₃, Ca = 65 mg/l (as Ca), conductivity 69mS/m and temperature = 15°C. Determine the changes of state with the following sequential perturbations: (i) heating to 90°C, (ii) bringing the water at 15°C to equilibrium with air, (iii) then raising its temperature to 90°C, and (iv) allowing it to precipitate 15 mg/l of CaCO₃.

A printout of the screen from the program showing the raw water quality and the effect of sequential treatments/changes in state is given in Fig. B5.4.

NAME: Affects of heating and/or CO2 exchange with air on hard groundwater						
TREATMENT PROCESS:	Initial	Heat	Heat	EqmAir	Heat	CaCO3
Unit:	Water	C	C	pp Atm	C	mg/l
Purity of Process Chemical:						100.0%
Amount:		90	15	0.00035	90	-15.0
PARAMETERS (mostly mg/l)						
Temperature	C	15	90	15	15	90
Conductivity	mS/m	69	68	69	68	66
Total Dissolved Solids		462	456	462	458	445
Calcium, dissolved	Ca	65.0	65.0	65.0	65.0	59.0
pH		7.40	7.28	7.40	8.64	7.88
Alkalinity	CaCO3	165.0	165.0	165.0	165.0	150.0
Acidity	CaCO3	194.5	194.5	194.5	153.3	153.3
Carbonic Species	CO2	158.1	158.1	158.1	140.0	133.4
CaCO3 PP	CaCO3	-5.5	42.8	-5.5	24.8	59.0

Figure B5.4: Printout of the screen of STASOFT 4 for Example 3, showing the raw water data and sequential heating to 90°C, bringing the water at 15°C to equilibrium with air, raising its temperature to 90°C, and allowing it to precipitate 15mg/l of CaCO₃.

Example B5.4: Blending of waters.

Two waters are to be blended, one a water that has been softened and the other a raw water. Analysis of the first water gives pH = 11.20, Alkalinity = 60 mg/l as CaCO₃, Ca = 15 mg/l (as Ca), conductivity 22mS/m and temperature = 20°C, and of the second water gives pH = 7.00, Alkalinity = 120 mg/l as CaCO₃, Ca = 45 mg/l (as Ca), conductivity 45mS/m and temperature = 20°C. Determine the blend proportion of the two waters to give a CaCO₃ precipitation potential of ~ 3 mg/l (as CaCO₃).

A printout of the screen from the program showing the raw water quality of water 1 is given in Fig. B5.5, and that of water 2 and the effect of blending the two waters in Fig.B5. 6.

NAME: Post softening blending (1)

TREATMENT PROCESS: Initial
 Unit: Water
 Purity of Process Chemical:
 Amount:

PARAMETERS (mostly mg/l)

Temperature	C	20
Conductivity	mS/m	22
Total Dissolved Solids		150
Calcium, dissolved	Ca	15.0
pH		11.20
Alkalinity	CaCO3	60.0
Acidity	CaCO3	-57.8
Carbonic Species	CO2	1.0
CaCO3 PP	CaCO3	-0.2

Page: 1 Modified

Figure B5.5: Printout of the screen of STASOFT 4 for Example B5.4, showing the data for the post softening water 1 for blending with water 2 (Fig. B5.6).

NAME: Post softening blending (2)

TREATMENT PROCESS: Initial BlendPg1
 Unit: Water % Page1
 Purity of Process Chemical:
 Amount: 30.0

PARAMETERS (mostly mg/l)

Temperature	C	20	20
Conductivity	mS/m	45	38
Total Dissolved Solids		300	255
Calcium, dissolved	Ca	45.0	36.0
pH		7.00	8.11
Alkalinity	CaCO3	120.0	102.0
Carbonic Species	CO2	128.4	90.1
CaCO3 PP	CaCO3	-32.5	3.1

Page: 2 Modified

Figure B5.6: Printout of the screen of STASOFT 4 for Example B5.4, showing the raw water data of water 2, and the effect of blending with 30% of water 1 (Fig. B5.5).

APPENDIX B5.1

Carbonate system thermodynamic equilibrium constants

$$\log_{10}K_1 = 356.3094 + 0.0609196*T - 21834.37/T - 126.8339*\log_{10}(T) + 1684915/T^2$$

$$\log_{10}K_2 = 107.8871 + 0.03252849*T - 5151.79/T - 38.9256*\log_{10}(T) + 563713.9/T^2$$

where

T = degrees Kelvin

Dissociation constant for water

$$\log_{10}K_w = 283.9710 + 0.05069842*T - 13323.0/T - 102.24447*\log_{10}(T) + 1119669/T^2$$

Calcium carbonate thermodynamic solubility constant

$$\log_{10}K_{sp} = 171.9065 + 0.077993*T - 2839.319/T - 71.595*\log_{10}(T)$$

Ionic strength, conductivity and total dissolved solids (TDS) relationships

$$\text{Ionic strength} = 0.000025*\text{TDS (mg/l)}$$

$$\text{EC (mS/m)} = 6.7*\text{TDS (mg/l)}$$

CHAPTER B 6: WATER FLUORIDATION

Frik Schutte

INTRODUCTION

A small amount of fluoride in the diet is essential for the development of strong and healthy teeth. Since the amount of fluoride taken in with food is limited, the fluoride intake has to be supplemented. It has been shown in many studies that the fluoridation of drinking water is the most feasible way of supplementing the fluoride intake of communities.

There is a long and ongoing debate over the benefits of fluoridation of drinking water versus the dangers and negative effects of fluoridation. Although the benefits of fluoridation are not disputed, many groups are strongly opposed to fluoridation of drinking water. Dental caries is a disease caused by specific bacteria harboured in dental plaque, fermenting carbohydrate to produce acid that can demineralise tooth enamel. If this demineralisation is allowed to continue, the enamel is penetrated permitting bacterial invasion and eventual loss of the tooth by decay in the absence of restorative dental care.

Dental caries can be reduced by the use of fluoride products. The level of dental caries (measured as the mean number of decayed, missing or filled teeth) falls from seven at a fluoride concentration of 0,1 mg/l to around 3,5 at a fluoride concentration of 1,0mg/l. As fluoride concentration increases further (up to 2,6 mg/l) dental decay continues to fall, but only slightly. The optimal level of fluoride for a temperate climate has been found to be around 1mg/l. This concentration seems to be associated with a substantial resistance to tooth decay but with only a small and cosmetically insignificant increase in the prevalence of dental fluorosis.

Dental fluorosis is associated with the ingestion of high levels of fluorides > 2mg/l over a prolonged period. It is characterised by discoloured, brown – stained or blackened, mottled or chalky white teeth.

One of the main arguments against fluoridation is that people do not have a choice to take or not to take fluoride when drinking water is fluoridated. Another argument against fluoridation is that the practice would create the possibility of accidents if excessive quantities are added to water due to poor control of operating plants. The counter argument is that high concentrations of fluoride have to be taken in the drinking water over a long period before harmful effects would develop.

In spite of the opposition against fluoridation, the RSA government has decided in principle that community water supplies will be fluoridated. There are certain situations that will be exempted from fluoridation (small operations), but all the regulatory aspects have not been finalised.

FLUORIDATION

Fluoridation of water involves the addition of predetermined amounts of a fluoride-containing chemical to the water during the water treatment process in order to increase the fluoride concentration in the water to a specific level.

The amount of fluoride to be added to water during treatment is determined by the concentration of fluoride that the treated water should have. This concentration is a function of the average maximum daily temperature of the area, because the temperature determines largely how much water people drink. This determines the amount of fluoride taken in daily. Tables of fluoride concentration in treated water at different temperatures will form part of the guidelines on fluoridation that will be made available before fluoridation is implemented.

Fluoridation Chemicals

The chemicals that are mostly used for fluoridation in other countries are sodium fluoride (NaF) sodium silicofluoride (Na₂SiF₆) and fluorosilicic acid (H₂SiF₆).

Sodium fluoride (NaF) is a white, odourless material available either as a powder or as crystals of various sizes. It has a molecular mass of 42, a specific gravity of 2,79 and a practically constant solubility of 4,0 g/100 ml (4 percent) in water at ambient temperatures typical for South Africa. Approximately 1,58 kg of sodium fluoride added to 1Ml of water gives a concentration of 0,7 mg/l fluoride, the concentration accepted for South African conditions.

When added to water, sodium fluoride dissociates into sodium and fluoride ions:

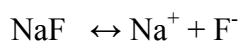

The pH of a sodium fluoride solution varies with the type and amount of impurities present. Solutions prepared from common grades of sodium fluoride have a pH near neutrality (approximately 7,6). Sodium fluoride is available in purities ranging from 97 to over 98 percent, with impurities consisting of water, free acid or alkali, sodium silicofluoride, sulfites and iron, plus traces of other substances.

Sodium fluorosilicate (Na₂SiF₆) is a white, odourless crystalline material with a molecular mass of 188,06 and a specific gravity of 2,679. Its solubility varies from 0,44 g/100 ml of water at 0°C to 2,45 g/100 ml at 100°C. When sodium fluorosilicate is dissolved in water, virtually 100 percent dissociation occurs rapidly:

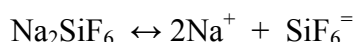

Fluorosilicate ions (SiF₆⁼) may react in two ways. Most common is hydrolysis of SiF₆⁼ releasing fluoride ions and silica (SiO₂):

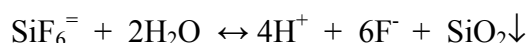

Silica, the main ingredient in glass, is very insoluble in water. Alternatively, $\text{SiF}_6^{=}$ dissociates very slowly, releasing fluoride ions and the gas silicon tetrafluoride (SiF_4):



Silicon tetrafluoride reacts quickly with water to form silicic acid or silica:

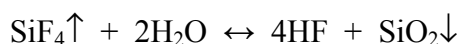
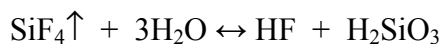

Solutions of sodium fluorosilicate are acidic, with saturated solutions usually exhibiting a pH of between 3 and 4. Sodium fluorosilicate is available in purities of 98 percent or higher. Principle impurities are water, chlorides, and silica. Approximately 1,66 kg of sodium fluorosilicate will add 1 mg/l of fluoride to 1000 m³ (1M) of water.

Fluorosilicic acid, also known as hexafluorosilicic, silicofluoric, or hydrofluorosilicic acid (H_2SiF_6), has a molecular mass of 144,08 and is available commercially as a 20 to 35 percent aqueous solution. It is a straw-coloured, transparent, fuming, corrosive liquid having a pungent odour and an irritating action on the skin. Solutions of 20 to 35 percent fluorosilicic acid have a low pH (1,2) and at a concentration of 1 mg/l of fluoride in poorly buffered potable waters, a slight depression of pH can occur. If the alkalinity of the drinking water is less than 5 mg/l as CaCO_3 and the pH of the water is 6.8 – 7, then adding 1 mg/l of fluoride could lower the pH of the drinking water to 6,2 – 6,4

Fluorosilicic acid dissociates in solution virtually 100 percent. Its chemistry is very similar to that of Na_2SiF_6 .

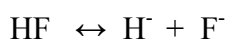
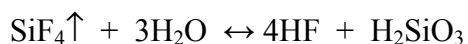
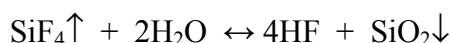

Fluorosilicic acid should be handled with great care because of its low pH and the fact that it will cause a “delayed burn” on skin tissue. Approximately 5,47 kg of 23 percent acid will add 1 mg/l of fluoride to 1000 m³ of water.

Hydrofluoric acid and silicon tetrafluoride are common impurities in fluorosilicic acid that result from production processes. Hydrofluoric acid is an extremely corrosive material. Its presence in fluorosilicic acid, whether due to intentional addition (i.e. fortified acid), or normal production processes, demands careful handling. Unlike chlorine fumes, fluorosilicic acid fumes are lighter than air and will rise instead of settle to the floor. (Silicon tetrafluoride [SiF_4] is a gas that is heavier than air but is

not toxic). Fluorosilicic acid seems to have a special affinity for electrical switches, contacts and control panels, as well as concrete.

FLUORIDE APPLICATION

Three methods of feeding fluoride compounds to water is in general use:

- dry chemical feeder for dry compounds;
- solution feeder for dissolved fluoride compounds;
- saturator feeder for smaller systems.

The first two methods are normally used at large treatment plants, while the saturator is restricted to smaller systems. The first two methods are also commonly used to feed other water treatment chemicals, while the saturator is a unique method for feeding fluoride.

The saturator feeding system is based on the principle that a saturated fluoride solution will result if water is allowed to trickle through a bed of sodium fluoride crystals. The saturated solution is then fed by a small pump into the main water stream being treated.

Selection of the most appropriate fluoridation system for a situation must be based on several factors, including population served or water usage rate, chemical availability, cost, and operating personnel available. Although many options are possible, some general limitations are imposed by the size and type of facility. In general, very large systems will use the first two methods, whereas smaller systems will use either an acid feeder or the saturator. Other factors important in the selection, installation and operation of a fluoride feed system are the type of equipment used, the fluoride injection point, safety and waste disposal.

TYPES OF EQUIPMENT

Fluoride chemicals are added to water as liquids, but they may be measured in either liquid or solid form. Solid chemicals must be dissolved into solution before feeding. This is usually accomplished by using a dry chemical feeder that delivers a predetermined quantity of chemical in a given time interval. Two types of dry feeders exist. Each has a different method of controlling the rate of delivery. A volumetric dry feeder delivered a measured volume of dry chemical per unit of time. A gravimetric dry feeder delivers a measured weight of chemical per unit of time.

Many water treatment plants that treat surface water utilize dry feeders to add other treatment chemicals and so use dry feeders for fluorides to maintain consistency with other equipment. Dry feeders are used almost exclusively to feed sodium fluorosilicate because of the high cost of sodium fluoride.

The saturator feed system is unique to fluoridation and is based on the principle that a saturated fluoride solution (4%) will result if water is allowed to trickle through a bed containing a large amount of sodium fluoride. A small pump is used to feed the saturated solution into the water being treated. Although saturated solutions of sodium fluoride can be manually prepared, automatic feed systems are preferred.

FLUORIDE INJECTION POINT

Ideally, the fluoride injection point should be a location through which all water to be treated passes. In a treatment plant, this could be a channel where other water treatment chemicals are added, a main coming from the filters, or the clear well. If a combination of facilities exists, such as a treatment plant for surface water plus supplemental wells, a point where all water from all sources passes must be selected. If no common point exists, a separate fluoride feeding installation is needed for each facility.

Another consideration in selecting the fluoride injection point is the possibility of fluoride losses through reaction with an adsorption on other treatment chemicals. Whenever possible, fluoride should be added after filtration to avoid substantial losses that can occur, particularly with heavy alum dosages or when magnesium is present and the lime-soda ash softening process is being used. If aluminium or iron salt coagulants are used and a fluoride compound is added before the metal hydroxide precipitate is removed, soluble aluminium and iron complexes can be formed, especially when the coagulation pH is less than about 6.5. In some situations, addition of fluoride before filtration may be necessary, such as in cases where the clear well is inaccessible.

When other chemicals are being fed, the question of chemical compatibility must be considered. The fluoride injection point should be as far away as possible from the injection points for chemicals that contain calcium, in order to minimize loss of fluoride by local precipitation. For example, if lime is being added to the main leading from the filters for pH control, fluoride can be added to the same main but at another point, or it can be added at the clear well. If lime is added to the clear well, fluoride should be added to the opposite side. If injection point separation is not possible, an in-line mixer must be used to prevent local precipitation of calcium fluoride and to ensure that the added fluoride dissolves.

SAFETY CONSIDERATIONS

Treatment plant operators must use proper handling techniques to avoid over-exposure to fluoride chemicals. Dusts are a particular problem when sodium fluoride and sodium fluorosilicate are used. The use of personal protective equipment (PPE) should be required when any fluoride chemical is handled or when maintenance on fluoridation equipment is performed.

DRINKING WATER STANDARDS FOR FLUORIDE

A large amount of work has been done to establish drinking water standards for fluoride in South Africa and in other countries of the world. The general conclusion emanating from all findings is that it is particularly important to consider climatic conditions, volume of water intake and other factors in setting national standards for fluoride. This point is extremely important, not only in setting national standards for fluoride but also in taking data from one part of the world and applying it in regions where local conditions are significantly different.

Temperature has been used in most cases to determine the optimum fluoride concentration at which minimal or no health effects will occur. This is because of a general understanding that fluoride concentration in drinking water is dependent upon environmental temperature.

In South Africa, the Target Water Quality Range (TWQR) of 0 – 1,0 mg/l fluoride is set for human health. This is the concentration range in water necessary to meet requirements for healthy tooth structure. This concentration is a function of daily water intake and hence varies with annual daily air temperature. A concentration of approximately 0,75 mg/l corresponds to a maximum daily temperature of approximately 26⁰C – 28⁰C. No adverse health effects or tooth damage is expected under these conditions.

Based on fluoridation studies conducted in the United States the US Environmental Protection Agency has established optimum and approval limits for fluoride in public water supplies. The recommended optimum concentration for a community is based on the annual average of the maximum daily air temperature from temperature data obtained for a minimum of 5 years and is calculated as follows:

$$\text{Optimal } F^- = [0,34] / [0,2364 + 9T / 5 * 0,0062]$$

T = annual average maximum day temperature °C.

CHAPTER B7: WATER TREATMENT PLANT RESIDUES

Frik Schutte

INTRODUCTION

The substances removed during water treatment constitute the waste products or residuals produced during treatment that must be disposed of in a safe and cost effective manner. These substances include the suspended and colloidal clay and organic material removed during sedimentation and filtration as well as debris such as floating material and algae removed from the raw water by screens. The residuals are removed as sludge from the sedimentation tanks, as wash water from backwashing of sand filters and as screenings from intake- and micro screens. The waste products from specialised process such as desalination processes (brines or concentrates) and softening processes (chemical sludge) must be treated and disposed of according to the nature of the specific type of residual.

There are different methods of handling and disposal of the waste products. Organic wastes must be stabilised before disposal, while inorganic wastes are normally concentrated or dewatered before disposal.

The sludge produced at a water works contains the colloidal and suspended material that settles in the sedimentation tank. The quantity and quality of the sludge is a function of the raw water quality (turbidity) and the types and dosages of coagulants and/or flocculants used.

Filter wash water constitutes the backwash water generated when backwashing sand filters.

Screenings is the material removed from screens installed at intake works.

For many years the primary place to deposit water treatment residues was in ponds, dumps or in the nearest river. Emphasis on environmental protection caused significant changes in the approaches to residuals handling and caused a big improvement in techniques for dewatering and disposal of waterworks residues.

SOURCES AND QUANTITIES OF RESIDUES

The amount of suspended solids produced in a works can be estimated on the basis of the type of coagulant dose rate and raw water quality. The total suspended solids collected in the sludge from the clarifiers and the filter wash water can be estimated from the following equation:

(Total suspended solids in clarifier sludge and washwater) = (Total suspended solids due to natural turbidity in raw water) + ("Additional" suspended solids from addition of coagulant or flocculant).

The "additional" suspended solids produced by the addition of coagulant or flocculant in the above equation depend on the type of coagulant or flocculant.

For coagulation with alum or ferric chloride, the "additional" suspended solids consist of precipitated coagulant in the form of aluminium or iron hydroxide, respectively. In the case of alum sludge an empirical formula for the aluminium hydroxide fraction of the "additional" sludge that is often used, is $\text{Al}(\text{OH})_3 \cdot 1,25\text{H}_2\text{O}$. Other researchers use $\text{Al}(\text{OH})_3 \cdot 3\text{H}_2\text{O}$ (AWWA) Using these formulas it can be calculated that about 0,35 g of "additional" sludge suspended solids will be produced for each g of alum [$\text{Al}_2(\text{SO}_4)_3 \cdot 14\text{H}_2\text{O}$] added. If a similar proportion of bound water is assumed for iron hydroxide sludges, the value for ferric sulphate [$\text{Fe}_2(\text{SO}_4)_3$] would be 0,59 g for every g of coagulant (flocculant) added and 0,48 g ferric chloride [FeCl_3].

The quantity of residue produced in the form of solids is calculated relatively easily by using a mass balance and appropriate chemical equations.

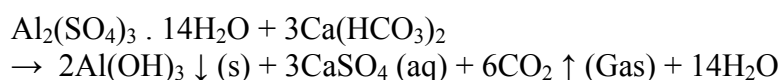

A coagulant input of 594 g produces 156 g of solids at a ratio of 0,26 g/g.

The following factors (g of "additional" sludge suspended solids for each g of coagulant added) for "additional" sludge for alum, ferric chloride and ferric sulphate have been established experimentally:

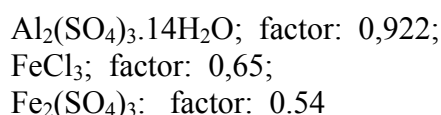

For a polyelectrolyte coagulant or flocculant, the amount dosed into the raw water will contribute directly to the "additional" fraction of suspended solids, i.e. for every g of polyelectrolyte added to the raw water a total of 1 g of suspended solids in the sludge (washwater) will be produced.

The determination of the amount of additional sludge produced where hydrated lime is used is more complicated as softening, solubility of calcium carbonate produced and unreactive material all have a significant effect. For Vaal Dam water, approximately 1,873 mg/l of CaCO_3 residue is produced from each mg/l of CaO added (Geldenhuys, 1995).

Another useful aid when estimating sludge solids produced by a water treatment process, is that for raw water turbidities < 100 NTU, the suspended solids in mg/l have been shown to be approximately equal to the turbidity in turbidity units (Montgomery, 1985). Caution should, however, be exercised when using this guideline for design purposes. For Vaal Dam water, for example, it was found that the relationship between turbidity as NTU and mg/l of suspended matter is 1:1,25 to 1:1.

The dosing of supplementary chemicals, such as bentonite for raw water conditioning and powdered activated carbon (PAC) for adsorption of taste and odour compounds, also contribute to the suspended solids collected from the clarifiers and filters. For design purposes it is assumed that for each g of bentonite or PAC dosed, a total of 1 g of sludge solids is produced.

Typical impact of source water on residue production

Source water	Average range of residue (kg dry solids per Mℓ)
Good quality reservoir water	15 – 30
Average river water	25 – 35
Poor quality reservoir water	30 – 40
Poor quality river water	40 – 55

The sludge volume depends primarily on the effectiveness of filter back-washing and removal of sludge using the minimum amount of water. The following points are important:

- The solids content of the sludge should be as high as possible to minimise water wastage, but low enough to allow easy pumping
- The sludge should have a consistency suitable to continuous operation of sludge handling and treatment processes.

CHARACTERISTICS OF RESIDUES

The characteristics of different types of sludge vary according to the chemical nature of the sludge. The main aspects of concern are:

- Suspended solids concentration, usually expressed as percentage dry solids. This should be as high as possible to minimise the amount of water loss with the sludge and to minimise transport and handling costs. On the other hand the concentration must not be too high so that it will cause pumping and handling problems.
- The settleability and settling rate of the sludge. Alum and ferric sludge settles poorly due to the gelatinous nature of these types of sludge. This causes problems with thickening and chemicals have to be added to enhance thickening and dewatering characteristics. When lime is used as primary coagulant the sludge consists mainly of CaCO_3 that settles readily.
- The chemical and bacteriological quality of the sludge and filter backwash water. With river supplies variations in source water quality may cause significant changes in the physical characteristics of residues. When there is a high algae content in the raw water the sludge will contain relatively large amounts of organic material. Anaerobic conditions may impact adversely on sludge characteristics and treated water quality.

SLUDGE REDUCTION

The cost of handling, treatment and disposal of treatment residuals is substantial and for this reason it is important to minimise or reduce the quantity of wastes generated. The following approaches can be followed:

- Selection of best quality raw water source. This is normally fixed in the design stage and there is little that can be done from an operational point. The only possibility is to ensure that the abstraction point is such that the best quality is

abstracted. Generally, the cleaner the source water, the less the residue that must be removed;

- The choice of chemicals and process has a direct impact on the quantity of residue. Lime produces more sludge than ferric chloride, which in turn produces more than alum. Polymers produce the least amount of sludge and, if used as coagulant aid, may reduce the quantity of residue from coagulation if their use results in reduction of the primary coagulant dose;
- Recovery of chemicals, such as metal salts or lime. This may only be feasible on large scale and costs are often prohibitive;
- Recirculation and reuse of filter backwash water. Direct recycling of backwash water to the inlet to coagulation could be considered where the intake water has a low turbidity and the particles in the backwash water may serve as nuclei for flocculation. This practice is rarely used in South Africa. The possibility of recycling pathogens such as *Giardia* cysts and *Cryptosporidium* oocysts is a concern. More commonly, supernatant from backwash water lagoons could be returned to the intake to reduce water losses. This should however only be considered if the the quality is acceptable with respect to taste and odour causing substances;
- The disposal cost of water works sludge can be reduced by exploiting the economic value of the sludge, for example by using it as a soil ameliorant or for use in the ceramics industry (lime sludge)

RESIDUE TREATMENT PROCESSES

Lagoons. Where sufficient land is available and in favourable climatic conditions lagoons are highly suited for storage and treatment of sludge and filter backwash water. Simple lagooning is one of the least expensive alternatives and can be used for all types of water works sludge. Over the long term it may be necessary to use mechanical equipment to remove the solids for transport to landfill.

Drying beds. These are in essence shallow lagoons provided with underdrains to remove water by filtration in order to accelerate the drying process. Alum sludge does not dewater very well and drying beds are seldom used for this type of sludge.

Gravity thickening. Thickening can be economically attractive because the volume of sludge is reduced substantially, requiring smaller dewatering process units if further treatment is required. Thickening tanks can also serve as equalisation basins to provide a uniform feed to downstream dewatering processes.

Vacuum filtration and belt filters. These types of filters are seldom used for dewatering water works sludge in South Africa.

Filter presses. Specially woven hoses are used for dewatering sludge. The dewatered sludge is removed from the hoses by passing them through a set of rollers. This system was developed by the University of Natal and performs very satisfactorily even for removal of *Giardia* cysts from the sludge-carrying water.

ULTIMATE DISPOSAL

The ultimate disposal of residues refers to disposal of residuals after thickening and or dewatering. The following are the major disposal areas for residues:

- The source from where the water was abstracted. This would normally be a river or dam and this way of disposal will not normally be permitted in South Africa.
- It is also possible to dispose of sludge to a sewage treatment works, depending on the capacity of the sewerage system to convey the sludge and the capacity of the works to accommodate the load.
- A landfill for dewatered sludge.
- Lagoons are often also used as final disposal, although it will be necessary at some point to drain and remove solids from the lagoon.

The choice of disposal area will dictate the type of treatment required and the degree of concentration needed to prepare it for that method of disposal. For land disposal, the residue must be as dry as possible to prevent problems at landfill caused by residue instability. A sludge concentration of around 25 – 30% is necessary for sanitary landfill.

SCREENINGS

Screens are placed at the entrance of a water treatment works, to keep out weeds, algae and other floating debris. Screens usually consist of a steel construction, and the screen openings are designed to remove specific type of suspended matter.

Coarse screens (10 mm – 100 mm) are placed at intake structures in dam walls, river intakes, etc. and their main purpose is to protect pumps, valves or other mechanical equipment. These screenings normally consist of grass, weeds, wood, etc. and could be disposed of in landfills or could be burned.

Fine screens are used to remove plankton and string algae from raw water. This type of screen would typically have openings of less than a millimetre, and the screenings would normally be wet. The screenings should be removed to suitable dumping sites where it could be allowed to dry out, and could eventually be composted or burnt.

Fine screening is often referred to as straining and could be considered as a pre-treatment process at the head of a water treatment works.

ALGAL SCUM

Algal scum can be taken from mechanical screens or strainers, but they can also come from a flotation plant where the water treatment plant has to deal with eutrophic waters. The primary aim is to reduce the volume of scum, i.e. to drain the water from it because a thickened scum has less weight and volume.

These residues can be disposed of in sludge lagoons, to an existing sewage works, or dumped on waste heaps. The dried algae can also be composted and then disposed of in landfill, etc.

For turbid waters (suspended solids 1000 mg/l or more), some 1 – 3% of the volume water treated can be generated as sludge i.e. say the water treatment works produces 500 m³ of water per day then some 15 m³ of sludge can be produced.

Various types of clarifiers are used to clarify water. The type of clarifier chosen is normally influenced by the quality of raw water to be treated. Raw water with high turbidity i.e. suspended solids concentrations of more than 1 000 mg/l is normally treated in horizontal flow clarifiers, where as moderate to low turbidity water with suspended solids 10 – 400 mg/l can be treated in vertical flow clarifiers with suspended floc blankets.

Each type of clarifier produces its particular type of sludge i.e. a vertical flow clarifier normally produces a less dense sludge and typical values vary from 2 000 mg/l to 10 000 mg/l whereas a horizontal type clarifier has a compartment or specific area where sludge can be compressed. This type of clarifier can produce sludge with concentrations varying from 10 000 mg/l up to 70 000 mg/l (1-7% m/v).

The aim must always be to discharge sludge as concentrated as possible as on a small works the water discharged with the sludge is very seldom reclaimed and is therefore lost.

In a small water treatment works as described above, holding ponds or dams must be provided of sufficient size to hold all the sludge produced at the water treatment works. The normal practice would be to have two dams side by side. This would allow the waterworks operator to take one dam out of operation, allow the clear water on top of the sludge layer to drain out, or evaporate. The sludge will dry-out, and this sludge can then be removed and used as landfill on a suitable site.

FILTER WASH WATER

In a conventional water treatment works with clarifiers and filters, the bulk of the suspended solids is removed in the clarifiers and a relatively small fraction by the filters. The filter washwater is relatively dilute (0,1 g/l to 1 g/l of dry solids concentration depending on type of filter).

The current practice in South Africa for the handling of filter washwater is either:

- to pump the washwater directly to the head of the water treatment plant when a filter is backwashed. The disadvantage of this option is that sporadic inflows of large volumes of washwater with high suspended solids concentrations at the head of the water treatment plant affect coagulation and flocculation processes;
- to capture the filter washwater in a holding tank of sufficient capacity. The suspended solids are allowed to settle in the washwater holding tank, which serves as a batch settling or thickening tank. When the level of washwater is high, the supernatant is pumped to the head of the water treatment plant. The settled solids at the bottom of the holding tank are pumped to the sludge thickening, dewatering or disposal facility on a regular basis, together with the sludge from the clarifiers.

If the water treatment works is run efficiently the filter wash water normally is between 2% to 5% of the volume water treated.

Chemical Wastes

In most water treatment works a number of chemicals are used. These include the main coagulant which is normally either a metal hydroxide or polyelectrolyte, a stabilising agent such as lime or sodium carbonate, sodium silicate, ammonium hydroxide, PAC and chlorine, either in liquid, gas or dry granular powder form.

These chemicals are fed into day tanks where they are diluted and fed with dosing pumps or gravity feeders to the incoming raw water.

It is good practice to clean the day holding tanks on a regular basis and the residues can be drained into the filter wash water/sludge system where it will find its way in the sludge lagoons. The residues should not be discharged in a natural watercourse as they could have a high pollution potential, for example slugs of the residues could change the pH conditions in small pools dramatically.

SETTLED SAND/GRIT

In treating raw water with extremely high suspended loads say 10 000 mg/l and above, it is customary to provide a sand trap at the head of the works.

This sand trap should be designed to allow settlement of sand grains of 0,1 to 0,2 mm size. In the smaller works this could be a shallow tank with a water depth of less than 1 m. Two compartments would allow the one side to be cleaned when the other is operational.

The fine sand retained can be dug out by hand and since there are no chemicals in the sand, the sand can be spread and used as landfill.

REJECTS AND CONCENTRATES

The processes used for the removal of dissolved inorganic substances always produce rejects and concentrates which must be disposed of and which require special methods to ensure that the environment is not polluted.

Ion Exchange

This process involves an exchange of ions from solution for exchangeable ions on the ion exchange resin. The ions removed from solution are concentrated on the resin. When the resin becomes saturated, it has to be regenerated using a strong acid, or alkali or brine solution. The regenerant stream resulting from regeneration contains very high concentrations of the ions removed from solution as well as excess regenerant chemicals. Great care in disposal of waste regenerant is required to ensure that there is no pollution of surface or underground sources as the salt concentration may be as high as 20 000 mg/l.

The usual method of disposal is a lined dam with sufficient area to allow for full evaporation and ensuring that overflow or leakage does not take place or to remove it to a licensed waste disposal site.

CHAPTER B8: ADVANCED PROCESSES

Frik Schutte

Introduction

There are a number of advanced processes that can be used for the production of water for domestic and other uses. These include membrane processes, activated carbon adsorption, ion exchange, chemical precipitation and oxidation processes. In this chapter an overview is presented of membrane processes since it is generally considered that membrane processes will play an increasing role in water treatment. Brief descriptions are also given of activated carbon adsorption, softening, removal of iron and manganese and ozone.

Membrane Processes

Membrane processes for water treatment have been developed in the 1960's when reverse osmosis membranes became commercially available. The application of these processes was relatively limited initially because of high membrane costs and high electricity consumption. However, membranes have become cheaper and the overall costs have reduced to the extent that the application of these processes has increased substantially over the last number of years.

There are a number of different membrane processes that can be used in water treatment.

Pressure-driven processes:

- reverse osmosis (RO), used for desalination of sea- and brackish water;
- nanofiltration (NF), used for softening of water and removal of natural organic material;
- ultrafiltration (UF) and microfiltration (MF), used for water clarification and removal of natural organic material.

Electrical potential-driven processes:

- electrodialysis (ED), and more specifically electrodialysis with polarity reversal (EDR)

These membrane processes have different characteristics, they have different applications, they use different types of membranes and membrane materials, their separation mechanisms are different, they operate at different pressure ranges, treatment costs are different and the quality of the product water is different.

Reverse osmosis. RO is a general desalination process being used to desalinate seawater, brackish water and high-TDS effluents. The membranes are continuous in the sense that they do not have any pores. The smallest size of dissolved ions and

organics that can be removed by RO is in the order of 0.1 nm (nanometer), which is equal to 0,0001 micrometer, or 0,0000001 mm. RO therefore removes all particulate matter including all bacteria and viruses, all organic macromolecules and most organic molecules with molecular mass of larger than about 150 Daltons (mol mass units). RO therefore produces product water of extremely good quality. The main application of RO is to remove dissolved substances, including ions such as Na^+ and Cl^- from solution. Operating pressure depends on the TDS content of the feedwater (osmotic pressure of feedwater) and varies from around 800 Kpa for brackish water to 7 Mpa for seawater.

Nanofiltration is also a desalination process since it separates dissolved salts from solution. However, NF membranes contain very small pores and therefore allow substances to pass that are retained by RO membranes. Monovalent ions such as Na^+ and Cl^- readily permeate the NF membrane, while divalent ions such as Ca^{2+} and SO_4^{2-} are rejected to a larger degree by NF membranes. It is therefore effective to soften water (remove Ca, Mg and other hardness causing ions). The types of membranes and modules are similar to those used in RO. Operating pressure is in the range of 500-1200 Kpa.

Ultrafiltration is similar to the above two processes in respect of driving force, but it differs greatly in that the membranes are porous. This means that separation is due to a sieve mechanism and dissolved ions and dissolved organics are therefore not removed. However, particulates and macromolecules are rejected. This means that bacteria and viruses are removed as well as larger organic substances such as the so-called precursors for chlorinated compounds such as THM's. This characteristic has resulted in the application of UF in drinking water treatment as an alternative for conventional coagulation-filtration-disinfection processes. Pore sizes in UF membranes range from 10-50 nm with operating pressures in the range 200-800 kPa

Microfiltration is very similar to UF with the main difference being pore size, operating pressure and permeate quality. Pore sizes are larger than 50 nm and operating pressures around 100 kpa. Only particulate matter and most bacteria and protozoa are removed by MF.

Electrodialysis is a membrane separation process in which the driving force is an electrical potential across the membrane. In contrast to pressure-driven processes where water is separated from the feed solution, in electrodialysis charged ions are separated from the feed water. This means that the product water contains less dissolved salts but that all non-charged compounds such as organic molecules and all particulates including bacteria and viruses will remain in the product water. This is a disadvantage of ED compared to RO but the process has certain other advantages which makes it competitive with RO in many applications.

ED membranes differ from RO membranes in many respects. ED membranes are charged, they allow either cations or anions, but not both to pass. This means that ED uses two types of membranes, cationic and anionic membranes. The separation mechanism is a charge-exclusion mechanism. The membranes are much thicker and more robust than RO membranes and the process operates at low pressure - slightly higher than atmospheric pressure.

The EDR process is similar to conventional ED except for the fact that the polarity of the membrane stack is reversed at regular intervals. The advantage of this is that the flow through the membranes is reversed regularly with the result that fouling of the membranes is greatly reduced. The main application of ED and specifically EDR is for the desalination of brackish water as well as desalination of certain effluents.

PROCESS OVERVIEW OF PRESSURE-DRIVEN PROCESSES

Figure B8.1 shows a schematic representation of a typical pressure-driven membrane process.

Typical membrane process

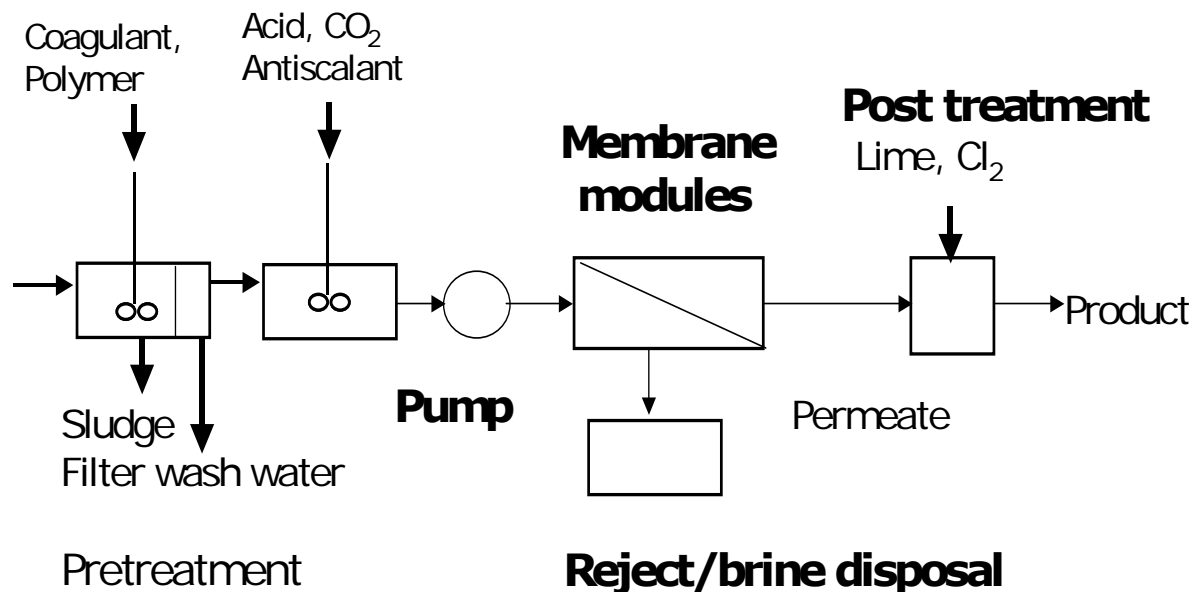

The following description relates specifically to RO, but the principles are similar for other pressure-driven processes. Differences between RO and the other processes are pointed out where relevant.

The RO process consists essentially of the following elements:

- RO membranes engineered into modules which form the basis of the process
- High-pressure pumps to deliver feed water at the required pressure to the modules
- Pre-treatment to produce feed water of the required quality that would not damage or foul the membranes

- Post-treatment to produce water of the required quality for the specific use of the water
- Process control equipment, including equipment and chemicals for membrane cleaning and preservation
- Energy recovery systems, normally only for larger scale applications
- Brine / concentrate and other waste disposal

The **membranes** essentially function as an extremely fine or dense filter by allowing water to permeate the membrane under high pressure in preference to dissolved constituents in the water such as dissolved salts and larger dissolved organic molecules. In addition to the dissolved substances, the membrane also separates all colloidal material including bacteria and viruses from the permeate, thus producing product water of high purity. The feed water is split into a high quality permeate stream and a reject (also called brine or concentrate) stream which contains the dissolved salts and other material removed from the feed water.

RO membranes can be described as polymeric films consisting of a number of layers, each performing a specific function. The top layer or membrane “skin” is a very thin, dense and non-porous layer of polymer that performs the separation function. The second layer is known as a porous support with a structure similar to that of an ultra-filtration membrane. Other layers essentially provide structural support for the manufacturing of the membranes.

The skin of an RO membrane does not have pores, so that transport of water and solutes across the membrane and separation takes place according to a solution-diffusion mechanism. This means that the membrane has a much higher affinity for water than for the solute (water will dissolve to a much greater extent in the membrane) and furthermore it will diffuse much faster through the membrane than the solute.

RO membranes are specified in terms of their **rejection** of NaCl at a specified pressure. This means that a 99,5% rejection membrane rejects 99,5% of salts in the water, whereas a 95% membrane may only rejects 95% of dissolved salts. This means that a 95% membrane is acceptable for the desalination of brackish water, but it is not suitable for single stage seawater desalination as the rejection of NaCl is much too low.

Membranes are manufactured from different materials like cellulose acetate, aromatic polyamide or even from different materials in the form of composite membranes. The different membrane materials have different chemical characteristics and are therefore affected differently by constituents in the feedwater. For example, pH has a serious effect on CA membranes since they are subject to hydrolysis when exposed to pH conditions outside the specified range of about 4.5-6. In contrast, PA membranes are much more resistant to pH changes over a much wider range. On the other hand, PA membranes are very susceptible to oxidation by even small amounts of chlorine in the water, while CA membranes can withstand small amounts of chlorine over extended periods of time.

RO membranes must be able to withstand very high pressures and must therefore be supported mechanically. The membranes are engineered into modules that are used in the desalination plant.

Membranes used for NF, UF and MF differ in some respects from RO membranes. The main difference lies in the density and porous nature of the membranes. Whereas RO membranes are very dense with a continuous skin and no pores, NF membranes are less dense and some contain an electrical charge. UF and MF membranes have a definitive porous structure that determines their rejection characteristics and therefore the membrane flux and quality of permeate.

Modules consist of the membrane, pressure support structures, feed inlet and concentrate outlet ports, and permeate draw-off points. The main types of modules are: spiral wound, hollow fibre, tubular modules and capillary modules. Figure B8.2 shows different module designs.

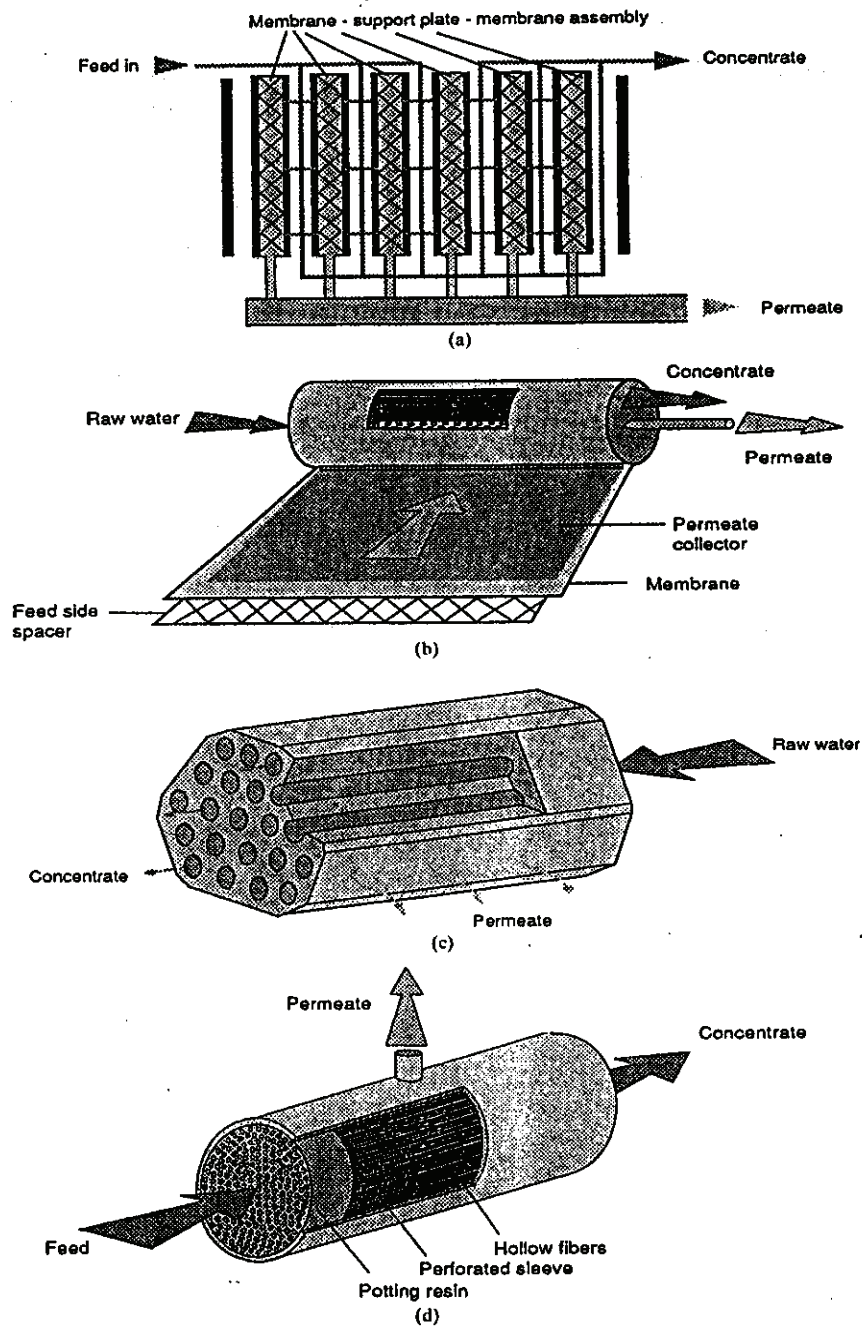

Schematic representation of the four principal membrane modules: (a) plate and frame; (b) spiral module; (c) tubular module; (d) hollow fiber.

Figure B8.2: Different module designs

Spiral wound modules essentially consist of an envelope of two flat-sheet membranes enclosing a flexible porous sheet (permeate collector) and sealed on three of its edges. The open edge is connected and rolled up onto a perforated tube that carries the permeate. Several “sandwiches” are thus fastened and separated from one another by a feed-side spacer. The spacer not only maintains an open flow channel for feed flow, but also fulfils the function of inducing turbulence, thus reducing concentration polarisation and the possibility of fouling.

Several elements (two to six) can be inserted into a single cylindrical pressure vessel. These are much more compact (700 to $1000\text{ m}^2/\text{m}^3$) and cause a lower head loss than the tubular or flat-and-frame modules. The spiral-wound module is, however, more sensitive to clogging than open-channel tubular or flat-sheet systems due to the spacer, and they require a fair amount of feed water pre treatment to prevent fouling of the membranes.

Hollow fibre membranes are manufactured by spinning the membrane material into very thin hollow fibres of about 100 micron in diameter. This structure gives sufficient strength to the fibre to withstand the high pressures of RO. Fibres are typically gathered in a bundle of several thousand and then sealed into a pressure tube by means of a potting resin. Flow of the feed takes place either inside the fibres (inside-out configuration) or outside the fibres (outside-in configuration).

Tubular module design is the simplest configuration in which the membrane is cast on the inside-wall of a porous support tube. These tubes have internal diameters typically in the range of 6 to 15mm. Individual tubes may be placed inside stainless steel or PVC sleeves for smaller-scale units or bunched together in bundles of up to 150 tubes in a cylindrical housing with appropriate end plates.

Capillary membranes are somewhat similar to small diameter tubular membranes. However, they do not have the structural stability to withstand the high pressures required for RO. Their main application is therefore in the field of ultra filtration.

Pre Treatment

Membranes are essentially very thin polymeric sheets, tubes or fibres that are sensitive to substances in the feed water that may cause fouling, scaling or hydrolysis of the membrane. In addition, environmental conditions such as pH, temperature and pressure have effects on the performance and life span of the membranes. In all RO applications some form of feed water pre treatment is required before the water is applied to the membranes. The degree or extent of pre treatment depends on the membrane and process configuration being used and the nature of the feed water.

Pre treatment is essential to protect membranes and control membrane fouling and can vary from relatively simple processes such as filtration and pH adjustment to complex processes including for example pH adjustment, chlorination, addition of coagulants (e.g., ferric chloride and polyelectrolytes), sedimentation, clarification, dechlorination (e.g., addition of sodium bisulphite), adsorption onto activated carbon, addition of complexing agents (e.g., EDTA, SHMP), and final pH adjustment.

Factors that are important and must be considered when pre treatment is contemplated are:

- Membrane material: how sensitive the material is to hydrolysis or degradation by oxidants such as chlorine or other constituents in the water
- Module configuration: how open or restricted flow passages are to allow high flow velocities and facilitate cleaning
- Feed water quality: the better the quality, the less pre treatment is required
- Recovery ratio: the higher the recovery, the greater the possibility that the solubility product of sparingly soluble salts may be exceeded and precipitation may occur

Different parameters may be used to evaluate the quality of the feed water. The first category gives an indication of the fouling tendency of the feed water and include:

- feed water turbidity expressed in NTU
- the organic quality of the water expressed as COD or TOC
- the Silt Density Index (SDI) determined by means of a special Millipore test apparatus.

Feedwater SDI requirements are different for different types of membranes and modules. Typical values recommended by suppliers vary from around 2 for spiral wound systems to 5 or even higher for tubular systems.

The second category of parameters gives an indication of the chemical properties of the water such as the scaling and hydrolysis potential of the water and includes:

- pH
- the concentration of potential scaling substances such as Ca^{2+} , Ba^{2+} , SO_4^{2-} , SiO_2
- the concentration of free chlorine and chlorine products
- temperature

The turbidity or SDI levels stipulated by membrane manufacturers from most feed waters are normally attained by conventional clarification techniques such as coagulation followed by sedimentation and sand filtration. Ultra filtration has been advocated as a viable pre treatment option capable of reducing the concentration of potential fouling substances to acceptable levels in a single operation.

Scaling control is essential in RO applications where the feed water contains substances that may precipitate (exceed their solubility product values) during membrane filtration. The limiting salt is the salt that will exceed its solubility product first upon concentration and can be determined from the solubility product values of potential limiting salts and the actual feed water quality. Different salts require different control strategies.

Calcium carbonate, CaCO_3 precipitation is normally controlled by acid addition to reduce the pH to levels where the alkalinity in the water is in the bicarbonate form, i.e. no carbonate is available for precipitation. Control of calcium sulphate, CaSO_4 precipitation requires a different strategy. In this case addition of substances that will prevent precipitation is required. These so-called anti scalants include compounds

such as sodium hexa meta phosphate (SHMP) , EDTA and proprietary mixtures of compounds. Anti scalants tie metal cations into complexes, making them unavailable for precipitation. In some cases softening of the water may be required as pre treatment to remove divalent cations to very low levels.

In the case of UF and MF where dissolved salts are not separated from the feedwater, pre-treatment requirements are much less stringent since there is very little danger of precipitation of sparingly soluble salts.

High Pressure pumps

The highpressure pumps play an important part in the functioning of an RO plant since the feed water must be applied to the membranes at high pressure. Typical feed water pressures for seawater desalination range from 5000 – 7000 KPa and for brackish water desalination from 1000 – 2500 KPa. These pumps must be protected from any substances such as sand that may damage them. Cartridge filtration (5 μ) is therefore normally specified for the feed water to the pumps. Proper maintenance of the pumps is an important prerequisite to ensure continuous availability of the pumps.

Post Treatment

The permeate from an RO plant is normally of very high quality since (almost) all potentially harmful substances such as micro-organisms and organic compounds are rejected by the membrane. Some chemical treatment may however, be required to produce a chemically stable, i.e. non corrosive water by adjustment of pH and addition of chemicals such as lime, Ca(OH)₂ .

RO operating principles

Water that contains dissolved inorganic salts exerts an osmotic pressure. In natural osmosis the osmotic pressure results in the flow of pure water across a membrane to the concentrate side of the membrane in order to minimise the free energy difference across the membrane. In reverse osmosis, the natural flow direction is reversed through the application of an external pressure on the concentrate side of the membrane. The pressure must be large enough to overcome the osmotic pressure as well as membrane resistance and allow a large enough permeate flow to make the process viable.

The pressurised feed water to an RO plant flows in a cross flow mode across the membrane (in contrast to the dead end mode of filtration through a filter paper, and deep bed mode of sand filters). The permeate dissolves into the membrane and diffuses through the membrane according to a preferential solution diffusion mechanism. The dissolved salts are not readily dissolved by the membrane and therefore permeate the membrane only to a very limited extent.

The three most important performance characteristics of RO membranes are:

- the volume of product water that can be produced on a sustainable basis (flux),
- the rejection of the undesirable components in the feed water, and
- the water recovery, i. e. the product water as a percentage of the feed water .

Flux (m_w) is expressed in terms of volume per area per unit time:

$l/m^2/d$ or $l/m^2/h$ or $cm^3/cm^2/s$

Solute rejection is expressed as the percentage of solute that permeates the membrane relative to that in the feed :

Rejection = [(concentration in feed) - (concentration in product)] / (conc in feed) * 100.

Pure water flux in general is subject to change with time as a result of compaction and also due to fouling. The term “compaction” refers to a densification of the whole membrane resulting in reduced flux, and to a lesser degree improved solute rejection. This phenomenon is explained as a “densification” or compression of the polymer structure thus reducing the rate of diffusion in the membrane. This is also reflected in the fact that higher rejections are obtained at higher pressures.

Water recovery of an RO plant refers to the quantity of product water obtained as a percentage of the feed water:

Recovery = Volume of product / Volume of feed water * 100

The higher the percentage recovery, the greater the conversion of feed water into product water and therefore the smaller the amount of brine produced. The water recovery is an important design consideration as it has a large impact on the costs of an RO plant. It is not always possible to achieve a very high recovery because there are certain constraints that often force the designer to accept much lower recoveries.

The most important constraint for high recoveries in brackish water desalination is the concentration in the brine of potential scale forming compounds and other fouling material. The extraction of relatively pure water results in an increase in the concentration of dissolved substances in the circulating brine stream, to the extent that the solubility product of sparingly soluble salts such as calcium sulphate may be exceeded and precipitation of the salt. In order to increase the recovery from feed water containing substances that could exceed their solubility product and precipitate, different pre treatment strategies may be followed. Calcium carbonate precipitation may be reduced by acid addition to reduce pH and convert carbonates to bicarbonates. Calcium sulphate scaling may be prevented by addition of anti-scalants or even softening of the water to remove calcium and magnesium from the water.

Applications

The main applications of RO include seawater desalination, brackish water desalination and desalination of saline effluents. The largest RO applications are for seawater desalination in Middle East countries. There are also many brackish water RO desalination plants in operation, but with relatively small capacities. Similarly, applications of RO for effluent desalination are also of much lower capacity. Some of the large capacity plants are in South Africa, e.g. the RO plants at Lethabo and Tutuka power stations and at Sasol, Secunda. These plants are in the size range of 5 – 10 M/d.

The main NF applications are for softening of water and for production of water from sources containing high levels of natural organic material (NOM) where NF essentially replaces conventional treatment. These applications are mostly in France and in Florida, USA.

UF is also applied as a one-process replacement of conventional treatment processes.

Disposal of brines and other wastes

The wastes from an RO plant consists mainly of the concentrate (brine or reject) from the desalination plant together with wastes from the pre treatment processes such as sludge from chemical precipitation or filter wash water. Provision must be made for proper disposal of such wastes in a manner that will not pollute the environment, e.g. ground water. Disposal of brines from seawater desalination normally does not present problems since the brine can be discharged into the sea. However, in the case of brackish water desalination disposal is normally done through evaporation from evaporation ponds. These ponds normally have to be lined and the construction costs together with the purchase cost of the land obviously add to the total treatment costs.

Operational Aspects

Membrane plants may be controlled manually or automatically, depending on the plant design and operating conditions. In automatically controlled plants the operating conditions such as flows and pressures are monitored and recorded continuously. Should any of these go outside the preset limits for the specific parameter, the plant normally shuts down automatically to prevent damage to the membranes or other parts of the plant such as the pumps.

A relatively high level of operating expertise is required for manual operation of RO plants. The pre-treatment and membrane cleaning processes involve the use of different chemicals and operators must therefore receive special training in the handling, make-up, and accurate dosing of different pre-treatment and membrane cleaning chemicals. In addition, operators must monitor pressure differentials across membranes, water fluxes and take the necessary action to prevent membranes damage if operating conditions go out of specification.

ACTIVATED CARBON ADSORPTION

Organic substances occur in water in suspended, colloidal and dissolved form. Suspended and colloidal organics can be removed from water by means of coagulation, sedimentation and filtration processes. Dissolved organics on the other hand, can only be removed by processes such as activated carbon adsorption, air stripping (for volatile organics) and reverse osmosis.

All natural waters contain small amounts of dissolved organic material. Most of the organic material is harmless and does not cause any problems in water for domestic use. There are however, many organic compounds in water that could be harmful or have other negative effects on human health. The substances of concern include those that cause taste and odour problems in water, disinfection by-products, and specific

substances such as organic pesticides. Activated carbon adsorption is effective for removal of these types of substances.

The removal of organic substances by activated carbon is an adsorption process by means of which organic molecules in solution are removed from solution and immobilised on the carbon surface. For this to happen, there must be a driving force that will cause a molecule to move from solution to the carbon surface and to adhere to the surface. There could be different driving forces but the typical driving force in water treatment is the affinity of the solute (organic molecule) for the solvent (water). The higher the affinity of the molecule for water (the higher the solubility), the less likely it will be adsorbed. The more a substance likes water (the more hydrophilic it is), the less likely it is to move toward an interface to be adsorbed. Conversely, a hydrophobic (water-disliking) substance will more likely be adsorbed from water.

The second primary driving force for adsorption is the affinity of the solute (organic molecule) for the solid (activated carbon). The main types of adsorption forces are Van der Waals forces of attraction, chemical attraction forces and electrical forces of attraction.

Physical adsorption is characterised by relatively low energy of adsorption, which means that the adsorbate is not held very strongly to the adsorbent. Chemical adsorption processes involve high energies of adsorption, because the adsorbate forms relatively strong bonds with active sites on the carbon. Most adsorption phenomena are combinations of the three forms of adsorption.

Activation of carbon is done by means of high temperature treatment of certain types of coal or other material such as wood, peat, lignite. Coconut shells and peach pips. The material is carbonized at temperatures below 700 °C in the absence of air. Activation is carried out in the presence of air or steam at temperatures between 800 and 900 °C. This process develops the internal pore structure of the carbon to produce a large internal surface area. The internal surface area of activated carbon is the most important parameter that determines its adsorption capacity. A value of greater than 900 m²/g is characteristic for a good quality activated carbon. The carbon can be produced in granular form of 0,6 - 1 mm diameter or in powdered form. The carbon type whether granular or powdered does not affect the internal surface area.

Adsorption systems

There are two basic activated carbon adsorption systems that are used in water treatment:

- Granular activated carbon (GAC) that is used as a bed of carbon granules through which the water filters.
- Powdered activated carbon (PAC) in which the carbon is used in powder form. The powdered carbon is mixed with water and after a certain period separated from the water.

Granular activated carbon is normally regenerated and reused, while powdered carbon is discarded after use.

Granular activated carbon adsorption takes place in filter beds of activated carbon. The carbon is placed in columns through which the water flows at a slow rate. The amount of carbon and the depth of the carbon layer in a filter and the flow rate determine the carbon contact time.

The empty bed contact time (EBCT) is an important parameter that determines the effectiveness of adsorption. Activated carbon does not have the same adsorptive capacity and rate of adsorption for all organic molecules. The longer the contact-time, the better the adsorption of even those compounds that are poorly adsorbed.

During the adsorption process the water comes into close contact with the carbon when it flows through a bed of carbon granules or is mixed with powdered carbon. As a result of the close contact, the organic molecules diffuse into and inside the pores of the carbon where they are exposed to physical and chemical forces that keep the molecule weakly attached to the carbon surface. When the surface of the pore is completely covered by molecules, the carbon is said to be exhausted. This means that very little further adsorption can take place and the carbon has to be regenerated to restore its adsorption ability.

The adsorption capacity is exhausted when breakthrough occurs of the compound (or groups of compounds) that is being removed. This means that the concentration of the particular compound starts to increase in the product water and breakthrough occurs when a pre-determined concentration is reached. The column must then be taken out of use and the carbon removed for regeneration.

The solute or impurity is adsorbed most rapidly and effectively by the upper few layers of fresh carbon during the initial stages of operation. These upper layers are in contact with the solution at its highest concentration level. The small amounts of solute that escape adsorption in the first few layers of adsorbent are then removed from solution in the lower layers of the bed, and essentially no solute escape from the absorber initially. The primary adsorption zone is concentrated near the top of the influent end of the column. As the polluted feedwater continues to flow into the column, the top layers of carbon become saturated with solute and less effective for further adsorption. Thus the primary adsorption zone moves downward through the column to regions of fresher adsorbent.

Granular activated carbon columns are normally placed last in the treatment train where as much as possible of all contaminants have been removed by the preceding processes. The reason is that carbon treatment is a costly process and other substances can reduce the adsorption capacity of the carbon if they are not removed before carbon adsorption.

Adsorbed material is removed from GAC through the process of regeneration. This normally takes place as follows: drying < 200°C, volatilisation < 500°C, pyrolysis 700°C, oxidation > 700°C. Steps must be taken to prevent air pollution as a result of volatilisation of adsorbed material.

Powdered activated carbon have the same adsorption characteristics as granular activated carbon; the main difference being particle size. The main advantages of PAC are low capital investment and flexibility. Dosage can be changed as required

and it can be used only when required. The main disadvantage is high operating cost compared to GAC. A further factor to be considered is the separation of the activated carbon slurry from the suspension and disposal of the waste carbon in such a way as not to cause pollution.

Powdered activated carbon adsorption functions on the same principle as the granular process. The main difference is that the carbon in this case is added to the water in a fine powder form. In this case the carbon is added early in the treatment process because it has to be removed by sedimentation and sand filtration from the water. In this case the contact time is determined by the hydraulic retention time of the carbon in the process units before it is removed.

The most important parameters in this case are the carbon dosage and the contact time. The carbon dosage is determined in adsorption isotherm tests in which the optimum dosage is determined for removal of the substances of concern.

The main advantage of powdered carbon is that it need not be used on a continuous basis, but can be used as and when the need arises. This means the overall cost is less than in the case of granular carbon where the activated carbon inventory in the columns represents a large capital outlay.

Applications

Activated carbon (granular or powdered) adsorption is applied in water treatment systems where problems with dissolved organic compounds are encountered. The most common applications include removal of tastes and odours from water, removal of chlorinated disinfection by-products, and the reduction of high concentrations of TOC that act as precursors for THM formation.

Operational considerations

There are major operational differences between GAC and PAC treatment. The handling of carbon granules does not present any great difficulty, while handling and safety are major issues in the case of powdered carbon. Specialised handling and storage facilities are required for PAC handling to contain dust and to prevent the danger of carbon dust explosions.

Operational considerations for GAC are in many respects similar to those for gravity sand filters. The main aspects include:

- Control of flow through the filter bed to ensure correct contact time (EBCT) between water and carbon.
- Backwashing of the carbon bed when pressure drop reaches a set value
- Monitoring of effluent quality to detect breakthrough of substances of concern
- Regeneration and replacement of carbon when exhausted
- Controlling biological activity in the carbon beds.
- Maintenance of adsorbers and transfer equipment

Operational considerations for PAC are mainly handling, dosing and removal of the PAC. The main aspects include:

- PAC can be fed as a dry powder using dry feed equipment or as a slurry using metering pumps. Dry feed systems should only be considered for relatively small systems. Dust is a major problem and special handling equipment must be used to minimise dust. Carbon dust is potentially explosive and special precautions must be taken such as use of explosion-proof motors. A much better way to dose PAC is to mix it with water and feed it as a slurry. PAC slurry solidifies if not mixed periodically. Feed lines and eductor lines can become clogged if they are shut down without being flushed to remove PAC slurry.
- The contact time between PAC and the organics in the feed water is important to ensure adsorption. PAC addition with coagulation provides the longest contact time before removal in the sedimentation basin and sand filters. Problems that can occur include coating of carbon particles by coagulant, thereby preventing contact with organics.
- PAC must not be dosed with oxidising chemicals such as chlorine or potassium permanganate since they will be reduced or adsorbed by the PAC.

CHEMICAL PRECIPITATION

Dissolved inorganic substances can be removed from water by precipitating the substances as an insoluble precipitate that can be separated from the water. Chemical precipitation is most commonly used to soften water and to remove specific substances from water such as heavy metals.

Softening of water

Hard water contains excessive amounts of calcium and magnesium ions and cause problems with formation of chemical scale in hot water systems and in distribution systems. Hard water also results in excessive soap and detergent usage because it does not foam or lather readily. Many ground water sources in South Africa, especially in dolomitic areas contain high concentrations of hardness-causing substances. It is advisable to soften hard water that is used in hot water systems to prevent scale formation and damage to boiler systems of hospitals, hostels, etc.

Hardness is expressed as the sum of calcium and magnesium ions in mg/l CaCO_3 . A typical classification of hardness is:

Soft:	<100 mg/l CaCO_3
Moderately hard:	100 – 250 mg/l CaCO_3
Hard:	250 – 400 mg/l CaCO_3
Very hard:	> 400 mg/l CaCO_3

Chemical softening involves the addition of chemicals to hard water to remove calcium and magnesium ions from the water by means of precipitating them in the form of calcium carbonate (CaCO_3) and magnesium hydroxide ($\text{Mg}(\text{OH})_2$).

There are different variations of chemical softening, depending on the quality of the feed water and the desired level of softening. When the objective is to remove calcium carbonate only, addition of lime to a pH of about 10,2 will be sufficient. However when calcium non-carbonate hardness (e.g. calcium sulphate) has to be

removed, sodium carbonate (soda ash) has to be used in addition to lime to provide carbonate ions in order to precipitate calcium carbonate. The lime-soda ash process is widely used for softening and involves the addition of lime to the water for the precipitation of calcium carbonate hardness, followed by addition of soda ash, Na_2CO_3 for the precipitation of calcium non-carbonate hardness.

In order to remove magnesium during chemical softening the pH must be increased to about 11,2 to allow magnesium hydroxide to precipitate.

The softening reactions can be illustrated as follows:

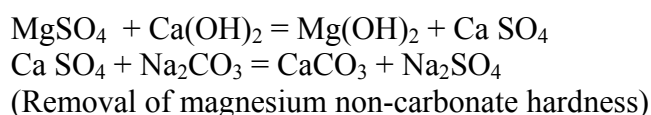
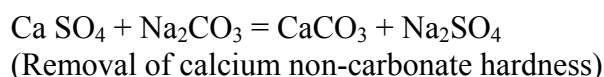
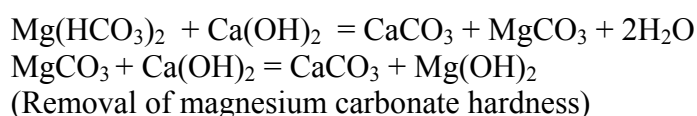
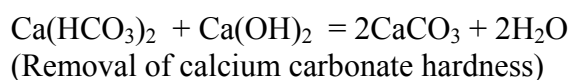

The calcium carbonate and magnesium hydroxide that form during softening are removed by sedimentation.

Softening takes place at elevated pH levels (11,2 for magnesium removal) and the water must therefore be stabilized before use. This is normally done by the addition of CO_2 to reduce the pH to about 7,5 to 8,5, a process called recarbonation.

Operational Aspects

Softening involves similar operational actions than coagulation with lime, i.e. dosing and mixing of lime with the water and removal of the sludge that formed by sedimentation.

Recarbonation involves the addition of carbon dioxide to the water and monitoring the pH to ensure adequate addition of CO_2 . Calculation of the required recarbonatin pH is done by means of the Stasoft program as is explained in the chapter on stabilisation.

REMOVAL OF IRON AND MANGANESE

Some inorganic compounds in water must first be oxidised to the chemical form that can readily be removed from water. Examples are iron and manganese that occur in some ground waters and some polluted surface water sources in relatively high concentrations. These substances are soluble and invisible and are not removed by conventional treatment processes. However, during water treatment and in the distribution system, iron and manganese may be oxidised and cause problems in the

distribution systems and in the home. The iron and manganese products precipitate and settle in the systems and may cause discolouration of water and staining of clothes. It is therefore necessary to remove high concentrations of iron and manganese by means of specialised processes in the treatment plant.

Dissolved iron and manganese occur in reduced form in some waters (Fe^{2+} and Mn^{2+}). The first step in the removal process therefore involves oxidation of the iron and manganese to forms that can subsequently be precipitated and removed during filtration. Oxidation can be achieved by means of oxidants such as chlorine, ozone, potassium permanganate, oxygen or air. The iron is normally precipitated as ferric hydroxide, $\text{Fe}(\text{OH})_3$, while manganese is precipitated as the oxide.

Dissolved iron occurs as Fe^{2+} and is readily oxidised to Fe^{3+} which can be precipitated as $\text{Fe}(\text{OH})_3$ and be removed during sedimentation and sand filtration. Iron can be oxidised by aeration of the water, but sometimes a stronger oxidant such as chlorine may be necessary when the iron occurs in complexed form.

Manganese is not readily oxidised by air and stronger oxidants are required. Potassium permanganate is an effective oxidant for the oxidation of Mn^{2+} to Mn^{4+} that precipitates as MnO_2 . The sand in a sand filter that is used for the removal of iron and manganese gets coated with a layer of manganese dioxide and this coated sand (green sand) assists in the removal of iron and manganese.

Operational Aspects

The oxidation of iron and manganese involves addition and mixing of chemicals in water. Addition of chlorine is similar to the operating aspects involved in disinfection. Addition of potassium permanganate involves make-up of the stock solution and addition and mixing thereof with the water.

ION EXCHANGE

Introduction

Ion exchange involves the exchange of ions in water for ions on an ion exchange resin. The resin can either be a cationic exchange resin or an anionic exchange resin depending on the functional group of the resin. A resin consists basically of a cross-linked polymer matrix to which charged functional groups are attached by covalent bonding. Typically the matrix consists of polystyrene cross-linked for structural stability with divinylbenzene. The common functional groups in resins are:

- Strong acid cation (sulphonate – SO_3^-)
- Weak acid cation (carboxylate – COO^-)
- Strong base anion (quaternary amine – NR_3^+)
- Weak base anion (tertiary amine – NH_2 , NHR , NR_2)

A schematic representation of a resin structure, cross-linking and functionality is shown in Figure B8.3. It shows a schematic three-dimensional bead made up of many polystyrene polymer chains held together by divinylbenzene cross-linking. The negatively charged ion-exchange sites are fixed to the resin backbone (matrix). Mobile positively charged counter ions are associated by electrostatic forces of attraction with each negatively charged site.

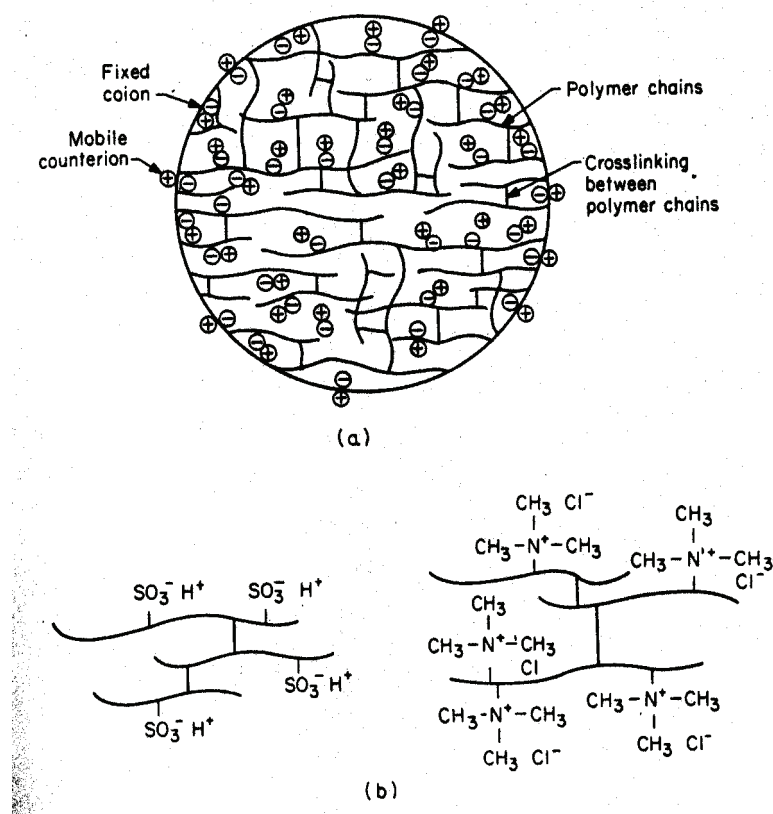
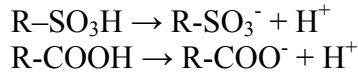

Figure B8.3: Schematic representation of ion exchange resins

The resin exchange capacity is measured as the number of fixed charged sites per unit volume or mass of resin. Functionality is the term used to identify the chemical composition of the fixed charged site, e.g. sulphonate or carboxylate. Porosity (microporous, gel or macroporous) is the resin characteristic referring to the degree of openness of the polymer structure.

About 60% of the resin bead consists of water. The resin-bound water is a very important characteristic of ion exchangers because it strongly influences both the resin kinetics and thermodynamics. The moisture content is a function of the degree of cross-linking.

Cation exchange resins are produced by the introduction of an acid group such as SO_3H or COOH into the polymer. If the polymer part of the resin is represented by R , the cation resin can be represented by $\text{R-SO}_3\text{H}$ or R-COOH . In water the resin dissociates as follows:



Strong-acid cation (SAC) exchangers operate over a very wide pH range of 2-12 because the sulphonate group is ionised over the whole pH range.

There are three typical SAC exchange reactions as shown below.

- In the first reaction the neutral salt CaCl_2 representing non-carbonate hardness is 'split' by the SAC resin and H^+ are exchanged for Ca^{2+} even though the liquid phase is acidic because of HCl production.

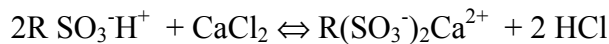

- The following two reactions represent the standard softening reactions in which sodium is exchanged for calcium ions as either carbonate or non-carbonate hardness. Regeneration is accomplished using an excess of concentrated (1 – 3 M) HCl or NaCl and constitutes the reversal of the reactions.

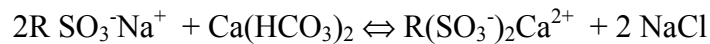
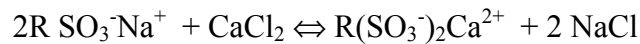

Weak-acid cation (WAC) resins can exchange ions only in the neutral to alkaline pH range because the functional group, typically carboxylate ($\text{pK}_a = 4,8$) is not ionised at low pH. WAC resins can therefore only be used for carbonate hardness and not for non-carbonate hardness removal.

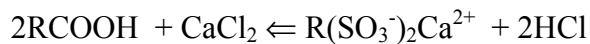
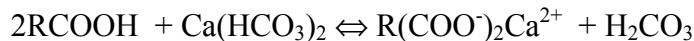

Strong-base anion exchangers function over a wide pH range because the quaternary amine functional group is ionised over the whole pH range.



Weak-base anion exchangers function only over the acidic pH range where the tertiary amine groups are protonated and thus can act as positively charged exchange sites.



Selectivity

Ion exchange resins have selective exchange abilities according to the type of ions. In the case of dilute solutions, the selectivity for **cation exchange resin** is:

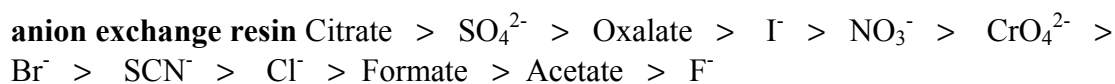
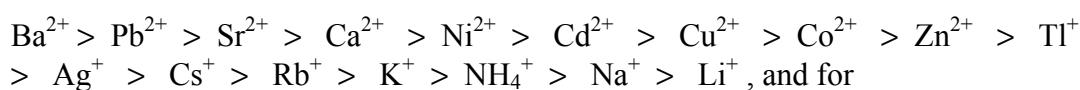

The **exchange capacity** of resins is an important characteristic because of its effect on process efficiency and system cost. The capacity is expressed either as total capacity (theoretical or ultimate capacity) or as operating capacity (breakthrough capacity). The total capacity is a measure of the total quantity of ions, which theoretically can be exchanged (number of ionisable groups) per unit mass or unit volume of resin and expressed as meq/l, meq/kg, mg CaCO₃/l etc.

Operating capacity is a measure of the actual useful capacity of the resin for exchanging ions from solution flowing through a fixed bed of resin. The operating capacity depends on the flow rate through the column, the bed depth, selectivity coefficient, feed concentration and regeneration efficiency. It can be defined as:

$$X = [\text{number of eqts applied to column}]/[\text{resin volume}] - [\text{number of eqts passing through column}]/\text{resin volume}$$

System operation

A typical fixed-bed operating cycle consists of four steps: service, backwash, regeneration and rinse.

Service (loading)

During loading the desired exchange reaction occurs, e.g. the exchange of Ca²⁺ for Na⁺. This means the Ca²⁺ concentration in the effluent will be below a certain maximum (breakthrough) value. As loading continues the available exchange sites become occupied with the exchanged ion (Ca²⁺) and the concentration of Ca²⁺ in the effluent starts to increase. Once the concentration reaches a pre-determined breakthrough value the resin is said to be exhausted and the exchange capacity must be resored by means of regeneration.

In effect, what occurs in an ion exchange column is a kind of multistage treatment where the solution passing down through the column is repeatedly brought into contact with fresh resin. After a short period of operation the upper part of the resin bed becomes exhausted. The applied solution passes unchanged through this part of the bed, but further into the bed it enters into the exchange zone, where the calcium ions displace the sodium form. As the column operation continues the exchange zone moves down the column until it reaches the bottom. At this point, calcium ions show up in the effluent; i.e. breakthrough occurs.

Backwashing

Backwashing with product water is employed after the operating capacity of the ion exchanger has been reached. This is an up-flow process used to prepare the resin for regeneration. Backwashing is required to:

- break up resin clumps
- remove finely divided suspended material entrapped in the resin by filtration
- eliminate gas pockets
- re-stratify the resin bed to ensure a uniform distribution of flow during down-flow operations.

Head loss and bed expansion in back washing through ion exchange resin layers are important factors in designing the system. These factors are affected by particle size, specific gravity of the resin, and temperature

Regeneration

Regeneration displaces ions exchanged during the service run and returns the resin to its initial exchange capacity or to any other desired level, depending on the amount of regenerant used. In general, strong acids are used to regenerate cation resins, while alkalis are used to regenerate anion resins. To minimise the regeneration time and the amount of regenerant used, the regenerant should provide a maximum peak elute concentration with minimum “tailing” of the elute. If the system is restored to its initial capacity, the number of equivalents of ions eluted from the resin during regeneration should equal the number of equivalents exchanged during the service cycle.

The regeneration efficiency is defined as the ratio of the total equivalents of ions removed from a resin to the total equivalents of ions present in the volume of regenerant used. Generally, the resin can be restored to full capacity by eluting all exchangeable ions. However, in many cases this may require that a large amount of regenerant is used which can prove to be very costly. As a result, only a portion of the available exchange capacity is normally restored during the regeneration cycle. The extent of regeneration is referred to as the regeneration level.

The regeneration efficiency is higher for weak ionic resins than for strong ionic resins because the weak ionic resins' affinity is higher for the H^+ and OH^- ions. This means that regeneration is more favorable for weak ionic resins, with the result that less regenerant is required to achieve the same degree of exchange.

Rinsing

After the regeneration step the ion exchange resin must be rinsed free of excess regenerant before being put back into operation. The rinsing procedure consists of two steps, using product water. The slow rinse stage displaces regenerant, and the waste from this rinse is combined with the regenerant brine for disposal. The fast rinse washes away excess ions, and the waste from that rinse is often collected and used for regenerant dilution water.

PART C: TREATMENT PLANT MANAGEMENT AND CONTROL

CHAPTER C1: GENERAL MANAGEMENT CONCEPTS

Frik Schutte

INTRODUCTION

Proper management of the water treatment function (in addition to proper plant operation and maintenance) is vitally important in order to safeguard the health of consumers and to ensure optimal utilisation of available resources (water, money, manpower).

Management can be defined as those actions and activities (of a manager) required to realise desired objectives through the inputs and efforts of other people (typically subordinates, but also other groups such as colleagues, contractors, consultants, suppliers, etc). This definition refers to the general tasks of all managers and includes the following activities: planning, organising, staffing, leading, controlling. In addition to these general tasks of all managers, each manager also has certain specific technical or administrative tasks that are different for different managers.

Strategic management is a very specific management function and involves the formulating of the mission, goals and strategies of an organisation or division or department of an organisation.

The more senior the level of the manager, the more of his/her time will be occupied by strategic management and the less on specific tasks. The more junior the level and the fewer the subordinates the more the specific tasks that will be assigned to the manager. But whether the supervisor has only one or many subordinates the same general management functions have to be carried out.

In summary, it is the basic task of all managers at all levels to develop and maintain an environment in which individuals working in groups can accomplish the objectives and goals of the organisation. Managers must take actions that will make it possible for individuals to make their best contributions to the group objectives.

What does this mean for a water treatment plant manager, superintendent, supervisor, senior operator or foreman?

In the sections that follow the most important functional aspects in water treatment will be analysed and management responsibilities and actions will be pointed out. It is, however, necessary to consider the general management functions in more detail before getting to practical aspects.

MANAGEMENT ACTIVITIES

Management functions can be classified as falling into the categories: planning, organising, staffing, leading and controlling.

Planning is essentially deciding what objectives that must be accomplished, what actions should be taken to achieve them and who would be responsible for the actions needed. Planning logically precedes all other management functions (organising, staffing, leading, controlling) but planning and controlling especially are inseparable - unplanned action cannot be controlled because control involves keeping activities on course by correcting deviations from plans.

Planning is a function of all managers although the nature of planning will vary with the level of authority. Unless an individual has some planning responsibility it is doubtful if such a person is a manager.

There are a variety of plans ranging from the mission of an organisation to the lowest level planning. It is easy to see that a major programme such as the planning for a new treatment plant is a plan, but it is often overlooked that a number of other courses of future action are also plans.

Planning also falls into categories of long-term, medium-term and short-term planning. Planning must be reviewed on a regular basis to ensure that existing plans continue to present the best course of action to follow.

Organising

People working together in groups to achieve some goal must have roles to play with a clear definition of such a role. This includes the responsibility of the role, the authority, the accountability, how it fits into the group effort, etc. Organising results in job descriptions and an organisation structure, i.e. which role (position) must do what.

Organising involves:

- determination of activities required to achieve goals;
- grouping these activities into sections;
- assignment of groups of activities to a manager;
- delegation of authority to carry them out;
- co-ordination of activities.

Staffing

Staffing involves filling and keeping filled, the positions provided for by the organisation structure. It includes selecting candidates for the position, training and development.

Leading

Leading has to do with motivating people so that they will strive enthusiastically towards the achievement of group and organisation goals. Effective managers tend to be good leaders. Some people are born good leaders, others have to be assisted and

trained to become better leaders. One of the key components of effective leading is good communication.

Controlling

Controlling is the measuring and correcting of activities of subordinates to ensure that everything goes according to plan. It is the activity of measuring performance against goals and plans, identifying where negative deviations exist and putting into action corrective measures.

MANAGEMENT ROLES IN THE WATER TREATMENT FUNCTION

There are different levels of managers involved in the water treatment function of any organisation (municipality, water board, industry). This range includes the Chief Executive, Engineering Manager, Plant Manager or Superintendent, Chief/Senior Process Controllers or Operators, Foreman, etc., each with specific administrative and/or technical functions in addition to the general management functions of planning, organising, staffing, leading and controlling. These managers must all contribute towards achieving the overall goals of the organisation. Let us now consider different functional aspects in water treatment and examine the role of different levels of managers in each function.

WATER QUANTITY MANAGEMENT

The demand for treated water must obviously be known to plan and control the production of treated water. Projections for future water demand must be done to allow sufficient time for planning and construction of extensions or to build a new treatment plant. These planning activities are normally done by a specialist planning function, i.e. higher level of planning. The plant manager must have access to this type of information to make provision in his planning and budgets for any possible new developments.

On the operations side the water quantity aspect or more specifically the plant water balance is important, as it is the primary factor that determines costs and the economy of the operation. In order to manage this function properly at the plant level the following information is required on a daily basis:

- Raw water intake
- Treated water produced
- Volume of filter wash water
- Volume of sludge from sedimentation tank/flotation unit
- Percentage water loss in different processes and overall for the plant.

This information will alert the plant manager for inefficiencies and must prompt investigations to improve efficiency if the performance falls below design levels or if it is lower than that of comparable plants. Since large volumes of water are produced and the losses are typically very small, accurate information is required. The following aspects are important:

- The actual flow path through the plant must be accurately known and accurate, calibrated meters must be installed at key points and the meters read and recorded daily
- All draw-off and intake points on the plant must be taken into account, e.g. water for operators houses, for gardens, for dust suppression
- If a reservoir forms part of the plant the variations in level, when readings are taken, must be taken into account in the calculations
- It might be misleading to calculate losses simply from the bulk meter readings into and out of the plant. Accuracies for these meters are typically $\pm 3 - 5\%$ and with water losses of the same order calculated losses may be totally misleading. It is preferable to install smaller meters on, for example wash water lines or to calculate sludge withdrawals and to use these figures to calculate losses.

Another important aspect is how the plant output relates to design capacity. When the demand is low, i.e. when the plant operates under capacity there is little pressure to optimise operations. However, when demand grows and it is sometimes required to operate the plant in excess of design capacity, the management input becomes much greater. It then becomes critical to optimise all processes, to keep equipment in full operation continuously, to plan for maintenance, etc. Under such conditions the effective manager will successfully perform the management functions of planning all aspects of the operation, motivating and leading the whole team, and controlling that everything goes according to plan.

WATER QUALITY MANAGEMENT

One of the key functions of managers involved in drinking water treatment is to ensure that the quality of the water produced complies with the requirements for human consumption. In water treatment for industrial purposes the specific process requirements must be achieved, e.g. hardness or dissolved solids limits for boiler feed water.

There are many sets of criteria or standards for water for human consumption, including those from the World Health Organisation, different countries, the South African Bureau of Standards (SANS 241 of 2001) and the South African Water Quality Guidelines (Vol. 1, Domestic Use, Department of Water Affairs and Forestry, 1996).

As a first step the treatment plant should be designed to accomplish the specific water quality criteria decided upon by the organisation, taking into account the raw water quality, variations in water quality, the size of the population to be served, the characteristics of the distribution system, etc. The philosophy of multiple barriers when treating polluted water must be built into the design. The design should then be translated into an operation manual in which the philosophy of the design is spelt out and specific operated instructions given for each process, group of processes and the plant as a whole.

The performance of the different processes and the whole plant must be monitored for certain key operational constituents in the water and a quality surveillance programme must be developed for the final water.

The selection of treatment processes, chemicals and dosages must be addressed in the design of the plant and in the operations manual. However, it is the plant manager who must manage all aspects of the process, from the development of a monitoring and surveillance programme, through all other management aspects down to control and the taking of corrective action in order to ensure that no water leaves the plants that does not comply with the set quality requirements.

The level or intensity of a water quality management programme will be different for different situations. In a very large plant such as those of Rand Water or Umgeni Water, one would expect fully equipped laboratories manned by suitably qualified chemists and microbiologists, automatic samplers, continuous monitoring of key parameters, detection and alarm systems, computer system to record data and to detect deviations from standards, etc. However, in a small treatment plant in a rural area the best one could hope for is perhaps hourly determination of turbidity and free available chlorine concentration in the final water and a monthly sample for full analysis by a central laboratory.

In both these cases, however, the responsible manager must develop a system to ensure that objectives are achieved. This should include the design of the overall system, compiling of an instruction manual, instituting control mechanisms to detect shortcomings in the system and deviations in water quality, as well as a reporting format.

Record keeping of essential information on analysis and operational performance is vitally important for possible queries or complaints regarding the quality of water produced.

COST MANAGEMENT

The total cost of treatment includes a number of cost elements including capital (interest and capital redemption), repairs and replacements, maintenance, chemicals used, electricity, cost of raw water, laboratory costs, staff costs, cost of water losses, etc. The contribution of each of these elements to the cost of water must be determined on a monthly basis. These cost contributions must be analysed, inefficiencies identified and savings measures instituted where necessary.

The cost elements consist of fixed and variable costs. Fixed costs are those that remain unchanged irrespective of the volume of water treated. It includes capital and staff costs and the cost of laboratory and other services provided. Variable costs are directly related to production and include the cost of chemicals, electricity, maintenance, etc. It is important to determine these costs accurately and maintain a full record of all costs.

The cost of different elements can be obtained from different sources, e.g. electricity from the municipal account or from KWh meters installed on the plant. The cost of chemicals from the invoices of suppliers or from calculations from average dosage of the chemical and volume treated. A good manager will reconcile these figures in order to detect overcharging should that happen or to detect losses through leaks or pilfering and illegal connections.

Budgets and budgetary control

One of the most important functions of a plant manager is to compile the annual budget for the operation of the treatment plant, in order to ensure that sufficient funds are available for operation and maintenance of the plant. Compiling of a budget should be zero-based (i.e. not simply adding a certain percentage to the previous budget) but calculating all costs for all aspects and adding these into the budget.

If the procedure is followed all the cost details are available to facilitate the process of budgetary control. This means that monthly financial reports must be compiled and compared with the approved budget. Any items where deviations occur must be investigated, the reasons for deviation ascertained and a programme of corrective action developed to rectify the situation.

MANAGEMENT OF PLANT PERFORMANCE

All the processes in a treatment plant must individually and as a whole perform according to specification in order to produce treated water of the required quantity and quality at the lowest cost. The plant manager and his staff must have a good knowledge of the operating principles and characteristics of each process, what needs to be done to optimise operation of each process and the plant as a whole, what the possible causes of malfunctioning or under performance could be, possibilities for upgrading processes and performance. These activities should involve the plant manager, operators as well as laboratory staff.

In order to be able to optimise processes, or to identify and quantify possible problems, accurate record keeping of certain key parameters is necessary. These include flow, chemical dosage, retention times, physical and chemical parameters and visual inspections and observations. However, just accumulating sheets and sheets of daily or hourly data does not mean much and is often a source of frustration for operators if they have the perception that nothing is being done with the data. The records must be analysed and transformed into usable information. Today it is rather simple even with a basic PC to calculate and plot running averages, to determine trends in data, to get the system to pick up deviations from pre-set limits, etc.

One of the important functions of a manager is to lead and motivate his team. Discussing operating performance on a daily or weekly basis with teams and setting of performance target is an excellent way of achieving this. At the same time such discussions can also be used to perform the manager's controlling function by setting action in motion to rectify deviations.

The provision, retention and training of operators to enable them to carry out their functions in the best way possible is perhaps the most demanding management task of the plant manager. The number of operators and the required qualifications for different treatment plant sizes and complexities are contained in Department of Water Affairs and Forestry Regulation R2834 of 1984 (which are currently being updated). Provision is made in this regulation for the registration of works based on the population served, quality of raw water, the process design and design capacity. It is, therefore, important that the plant manager should appoint the required number of

operators with the required qualifications. However, this is not always possible and in many instances plants have to be operated with under-qualified people. An important function of the plant manager in these cases (but also in fully staffed plants) is to provide training and mentoring to operators and trainees in order to develop a competent team to ensure effective and efficient operation.

A vital aspect of plant operation is ensuring the sufficient chemicals of the right quality are available without interruption. This requires a proper stock control system with failsafe indicators as to when to order what quantity of what chemical from which supplier, taking into account delivery times, the possibility of delays, etc. This aspect is extremely important in rural areas far away from the main centres where delivery times can be quite long and deliveries not always as reliable as one would like.

Some chemicals have a limited shelf life and may lose activity with time. This aspect should be taken into account when ordering large quantities. Furthermore, stock control should ensure first in first out (FIFO) in chemical usage.

MANAGEMENT OF PLANT INTEGRITY

Proper functioning equipment is a prerequisite for a proper operating plant. Management of the servicing, maintenance and replacement function of a treatment plant is one of the important functions of a plant manager.

This entails a number of aspects, including:

- Establishing complete schedules of all equipment that needs servicing and maintenance with details of the frequencies of action to be taken
- Establishing a programme of actions by servicing and maintenance staff to carry out the required actions
- Controlling that these programmes are carried out properly
- Developing inspection schedules and techniques to detect imminent problems before they occur.

The effective manager will see to it that proper systems are in place to ensure that all equipment are maintained in a good working condition. Properly functioning equipment is the heart of properly functioning processes and a properly functioning plant. However, the maintenance function is often neglected due to the fact that neglect is not immediately visible or if budgets have to be reduced or savings effected, it is often done on maintenance. Such actions are very short-sighted as a very expensive price will be paid in the longer term when neglected equipment fails or breaks down and have to be replaced at high costs.

It is a fact that maintenance is not the most visible and most “glamorous” function on a treatment plant - yet it is one of the most important functions. It is for this reason that the effective manager will go out of his way to support the maintenance staff and control that maintenance is carried out properly.

CHAPTER C 2: WATER TREATMENT PLANT CONTROL

Attie Goosen

INTRODUCTION

Proper process and plant design and proper operation and control of water treatment processes and plant are both essential for efficient and cost-effective production of water of the desired quality. Process and plant design are fixed once the plant has been constructed, after which it is the ongoing responsibility of the plant manager and process controllers to cost-effectively produce water of the required quality.

Process and plant problems are often ascribed to either poor design or poor operation (or both). However, once a plant has been constructed, it is obviously very difficult and expensive to change the process design and invariably the problems on a treatment plant have to be solved through adjustments and innovations to operational procedures and control parameters.

It is evident that over the lifespan of a treatment plant proper operation and control has the most significant influence on treated water quality. It is therefore essential that effective control measures should be in place to prevent problems from developing or to detect potential problems as early as possible in order to take corrective action.

The plant control philosophy should be based on the design philosophy, nature and quality of the raw water, plant conditions, available staff, economics and the community it serves. The control philosophy and control measures must be uncompromising as far as treated water quality and protection of the health of the community is concerned.

CRITICAL ASPECTS

Critical control points can be defined as those parameters that can affect further processes in the treatment train or those that can lead to process failure. Examples of such parameters are:

- Inadequate coagulation can adversely affect flocculation, sedimentation, filtration and disinfection. This can then be shown to have an indirect health impact due to inadequacies that may occur in the disinfection process.
- Sub-optimum flocculation can result in poor sedimentation; impaired filtration resulting in increased filtered water turbidity or lower filter production runs and again inadequacies in disinfection.
- Certain filter plant failures can result in reduced filtration efficiencies being experienced. In sand-filters this can be due to loss of filtration medium (sand), mud ball formation due to inadequate backwashing, mal-operation like putting a filter in operation when it is drained without first filling and thereby disturbing the filter media or failure of the support structure or collection system. All such failures will impact adversely on the disinfection of the water.

- A critical aspect in ensuring adherence to health requirements of potable water is efficient disinfection. Apart of the abovementioned factors adversely impacting on disinfection other factors can also have a pronounced effect on disinfection efficiency. In this regard the disinfectant dose, contact time, proper mixing and disinfectant species are important.

Dependent and independent variables

Certain variables on a plant are considered to be independent and not under the control of process controllers, while other variables are dependent on the functioning of preceding processes and therefore dependant variables. Turbidity of the raw water can be considered to be an independent variable. This aspect is not controllable by the treatment plant personnel unless different raw water sources can be selected whereby a less turbid water source can be used as influent to the plant when increased (high) turbidity is detected in the normal influent.

Water supplied from a run of the river source is especially prone to variations in raw water turbidity. Raw water obtained from a dam is generally more stable regarding turbidity although the intake position at the dam can result in large turbidity variations being experienced. Such variations are to be expected during flood conditions and even when rainfall causes inflow of highly turbid water from tributaries into a river from which water is abstracted or into a dam close to the abstraction point.

The raw water quality determines to a large extent the water treatment regime used. In this regard the raw water turbidity is an important parameter. The coagulant used may be dependant on the turbidity but the dosage of the chemical is determined by the raw water turbidity. Changes in raw water turbidity will invariable require adjustment of the coagulant dose rate being used to obtain optimum coagulation and flocculation. Coagulant dose rate is thus a dependent variable but is controllable by the operating personnel. Local operating instructions should be prepared to address this aspect if variations in raw water turbidity are expected to occur.

Ineffective coagulation and flocculation can have an adverse impact on downstream processes. Inefficiencies during the coagulation process will result in non-optimal flocculation that will result in poor sedimentation because of stable colloidal particles that are still present in the water. This in turn will result in ineffective filtration due to the colloidal particles not being removed in the process. The presence of these turbidity particles in the filtered water will not only impact on the turbidity of the filtered water but can also result in inefficient disinfection resulting in adverse health effects being experienced.

Mixing intensities during the dosing of coagulants and the flocculation process play a major part in process efficiencies. Flash mixing (rapid mixing) is important regarding the coagulation process. High intensity mixing over a relatively short time span is required in this process to ensure complete mixing of the coagulant and raw water. Micro-flocs are formed during the operation but these can be broken, due to the high shear rate, when the high intensity mixing is sustained for a long time. During flocculation less intense mixing is applied and the micro-flocs aggregate into larger particles that settle more readily.

The settling takes place in a quiescent basin where the allowed up flow velocity is determined by the settling velocity of the particles. Should the up flow velocity be higher than the settling velocity floc carry-over will occur and the filtration will be affected.

Filtration efficiency will not be adversely affected by carry-over of well-formed floc but the productive length of the filter run will be compromised and lower filtrate volumes will result throughout the plant. This will reduce the finished water throughput through the plant due to a higher percentage of the water being used for filter backwash.

Inefficient backwash of filters can result in reduced filter production runs and the formation of mud-balls in the filter bed. Mud-ball formation results generally from too short backwash periods or too low backwash water. Excessive backwash flow is not effective in removing filtered material from the bed and also results in loss of filter media and excessive water usage.

Controllable aspects

Based on the above discussion the controllable aspects can be listed as:

- Coagulant concentration.
- Sedimentation tank up-flow rate by reducing the volume of water treated according to the design capacity of the plant.
- Filter backwash rate.
- In isolated cases it may be possible to change the raw water source.
- Depending on the equipment installed changes to the mixing intensity of flash mixing and mixing in the flocculation chamber may be possible.

Set limits

Coagulant dosage is dependant on raw water quality and type of coagulant. Limits regarding this must be set at the plant.

The size and shape of the floc particles can be a rough guide to establishing probable problems that are being experienced. When a lack of flocculation is noticed in the flocculation chamber the first action to be taken is to see that the coagulant dosing equipment is delivering the chemicals at the required rate. Normally a reduction in coagulant dose rate is experienced but other factors can also play a role:

- The wrong chemicals could have been used to make the batch
- The coagulant used is not to specification
- Too little chemicals could have been added to the batch
- Coagulant dose is too low
- Too much coagulant could have been used to make the batch. In this case pin floc may result due to re-stabilisation of the colloidal particles.

The velocity gradient (G) used during **flash mixing** should be in the range of 700 to 1 000s⁻¹ depending on the equipment used. The Gt (dimensionless) value, which is the

product of the energy input and the retention time, should be in the range of 5 000 to 20 000 depending on the equipment used. This is thus a short-time high-energy input operation.

The velocity gradient used during **flocculation** should approximately be 10 to 150 s⁻¹ depending on the equipment used. The Gt value should be in the range of 9 000 to 18 000 depending on the equipment used. This operation lasts a relatively longer period with a much lower energy input compared to flash mixing.

During the quiescent **sedimentation** process the up-flow velocity must be maintained below or equal to certain design maxima. The maximum up-flow velocity range from 2 m.h⁻¹ for sedimentation tanks up to 20 m.h⁻¹ for solid contact and sludge blanket clarifiers. The maximum allowable up-flow velocity is clearly a plant specific entity that must be adhered to.

Sludge removal can either be done intermittently or continuously. Regardless of the removal method the removal rate should be adjusted when turbidity variations are experienced. Inadequate sludge removal leads to sludge accumulation in the sedimentation section and this can ultimately result in microbiological activity in the sludge bed (septic sludge) with the concomitant release of metabolites into the water phase. The growth of micro-organisms can also result in increased organisms being present in the aqueous phase with resultant impacts on filtration and disinfection.

Various problems associated with **filtration** plants can be ascribed to either poor design or poor operation. Only operational aspects are mentioned here.

- **Mud balls.** Mud balls are conglomerations of coagulated sand, suspended matter floc and other binders. Newly formed mud balls are small, light and should not occupy more than about 0,1% of the volume in the top 150 mm of a gravity sand filter bed. They tend to collect on the surface of the bed after backwashing and can be removed by suction from the surface. When they are allowed to grow in size they increase in density and eventually become heavy enough to migrate down the bed until finally resting on the gravel layer at the bottom. The mud balls accumulate there and clog portions of the bed resulting in uneven backwashing with gravel being lifted and mixed with the sand.
- **Filter cracking.** Filter cracking is also a phenomenon that is related to inadequate backwashing of a sand filter. This results from a thin layer of compressible matter around each grain of the medium. Due to the increase in pressure drop during the filter run the grains are squeezed together and cracks form in the filter medium. The cracks normally start at the walls of the filter box but in severe cases it can occur randomly through the surface. These cracks forms areas of lower hydraulic resistance and they can thus lead to short-circuiting of the flow and result in poor quality water being produced.
- **Jetting and sand boils.** Small differences in porosity and permeability of sand and gravel cause the first water entering a filter bed during backwashing to follow the path of least resistance. This leads to the to the initial water flow breaking through to the surface at scattered points. At these points of flow the clogged and compressed sand is fluidised resulting in reduced backpressure. This in turn results in increased flow and water is jetted from the gravel layer into the sand. In

extreme cases this can result in mixing of the gravel and sand with the bottom gravel layer being partially relocated to the top of the bed.

- **Sand leakage.** When properly sized filter media and gravel is placed in a rapid sand filter, sand should not find its way into the under-drainage system. The problems associated with sand and gravel displacement mentioned above can however lead to sand getting eventually in the under-drainage system. When a lateral system with collecting nozzles is installed nozzle failure can lead to sand ingress. This is normally noticeable from a “crater” forming at the surface of the filter where sand leakage is taking place. During backwash sand boiling will also be noticeable at the breakage point.

The **disinfection** process is the single most important process used to ensure that the product water does not pose a health risk to the consumers. Failure of this process can lead to serious waterborne disease outbreaks and such outbreaks have led to litigation in the United States of America.

Disinfection of potable water can be achieved using a variety of chemicals. These include gaseous chlorine, calcium hypochlorite, sodium hypochlorite, chloramines, chlorine dioxide, ozone, ultraviolet light and hydrogen peroxide. The most common disinfectants are the chlorine compounds and ozone to a lesser extent. Apart from these chemicals the preceding processes play an important role in the removal of viruses, bacteria, protozoa and cysts.

The chlorine compounds result in detectable residuals being left in the product water when dosed at sufficient concentration. The other disinfectants do not result in a residual being present in the water for any length of time and no protection are afforded regarding microbial contamination in the distribution system.

Effective disinfection can only be ensured when the required disinfectant residual is present after the specified contact time. It must be stressed that the presence of a residual disinfectant concentration on its own does not necessarily implies that the water is of an acceptable bacteriological quality. This can only be confirmed by regular microbiological testing of the water.

When other disinfection methods are used that do not result in residual concentrations in the product water it would thus be advisable to add chlorine-based disinfection chemicals to ensure a residual and protection against microbiological contamination and growth in the reticulation network.

Corrective actions

Coagulant dosing. Areas that need to be addressed are associated with the efficiency of dosing. Blockages in the dosing lines can go unnoticed but hourly records of the dosing tank levels can give an indication of reduced dosage. Blockages of the suction strainer and both the suction and discharge lines can result in reduced dosage rates. These causes are apart from the obvious failures such as broken pipes, inoperative pumps and power failures. All such failures must be addressed to rectify the problem.

When polyelectrolyte is used as a coagulant, or flocculant aid, foam collection at the flocculating chamber is a sign of possible over-dosing of the chemical. Reducing the

dosing rate of the polyelectrolyte can rectify this. Confirmation of overdosing of polyelectrolyte can be done by an empirical test where a small mass of bentonite powder is added to the filtered water and the sample is then subjected to a normal jar test as used for coagulation-flocculation studies. Floc formation during this test is indicative of excess polyelectrolyte being present in the filtered water.

Mixing. Mixing can be done with a wide array of equipment. These range from hydraulic systems to mechanical equipment.

Hydraulically driven systems like static mixers, hydraulic jumps and orifice plates all suffer from the limitation of optimum mixing being achieved only within a relatively narrow linear fluid velocity range. Operating a plant below this design flow rate range can thus result in poor mixing and it is better operating practice to operate the plant intermittently and start on demand rather than attempting to adjust the flow according to demand to ensure continuous operation if possible.

Mechanical equipment operates largely independent of the volumetric flow rate and problems associated with this type of equipment are therefore related to mechanical and power failures.

In the **sedimentation** basin problems are generally associated with the use of the wrong coagulant, inadequate coagulant dosing or coagulation and flocculation failures. When metal salts are used as coagulants the pH and alkalinity of the water is changed. When an excessive drop in these parameters is noted it is indicative of overdosing of metal salt coagulants.

A sedimentation basin is designed for a certain maximum up-flow velocity and excessive flow through the basin normally results in entrainment of floc with a coincidental increase in turbidity of the product water. The flow rate through a sedimentation basin must thus be controlled at or below this maximum flow rate.

The operational problems discussed previously regarding **filtration** can all be ascribed to improper cleaning techniques. The problems are mainly related to improper backwashing techniques and they need to be addressed by adherence to the backwash sequence prescribed by the equipment supplier.

Mud ball formation and filter cracking are due to either inefficient air scour or too low flows and throughput during backwashing. It is important to note that the backwash flow rate should be started at relatively low flow and increased to the recommended flow over a reasonable time period during the backwash cycle. This approach will prevent sand boiling and disruption of the gravel layer. It is important to reach and maintain the required backwash flowrate through the bed during the majority of the time allowed for backwashing to ensure that all the accumulated suspended matter is washed out of the bed. The time period from start to full backwash should be at least 30 seconds but preferably not more than a minute.

A dry filter should never be put into operation without a prior backwash. It is very important to open the backwash valve slowly when backwashing a dry filter bed to prevent water hammer in the under drain system. Water hammer can destroy the under drain system and can lead to severe gravel disruption.

Air scouring is an important operation that assists in cleaning the filter media. The air scour dislodges deposits from the media is followed by a water wash to expel the deposits out of the bed. In South Africa it is the normal practice to use air scour as the initial step in backwashing followed by a water backwash. On newer plants with automated backwashing facilities sequencing of two or three backwash cycles are sometimes instead of one to partially eliminate a drawback of air scouring that results in sand compaction. This is one of the reasons why fairly short air scour times, 1 to 3 minutes, are used. The normal flow rate during air scouring is 18 to 36 m/h while the water backwash rate is set at 12 to 30 m/h depending on the effective sand size.

Some plants use simultaneous air scour and water backwash where air is admitted simultaneously during the initial backwash period. This is used on coarse-grained sand filters, effective size $>0,9$ mm, and higher airflow rates of 50 to 60 m/h are used. The water flow rate used during this period ranges from 10 to 15 m/h. After 5 to 10 minutes the airflow is stopped and the water flow rate may be increased to 15 to 25 m/h but should remain below the fluidisation velocity of the sand.

The flow rate of the backwash water the water velocity should not be allowed to be so high that filter media is washed out of the filter. The filter media is fluidised and the bed is expanded during backwashing. Excessive bed expansion will lead to media loss and must be avoided.

Problems arising during **disinfection** are mainly related to equipment failure, inadequate dosing or changes in the water quality.

Equipment failure can be classified broadly in failures of chlorine gas transport systems and failures of dosing equipment. Transport system failure can be associated with chlorine gas delivery or motive water delivery. Such failures are normally due to pipe blockages, pipe rupture or supply interruptions.

Rupture of chlorine gas pipes result in the release of chlorine gas and this is a major safety hazard that must be addressed as a matter of urgency. Adequate precautions must be taken when such a leak is experienced. The gas supply should be closed off immediately. Breathing apparatus, preferably a self-contained breathing apparatus must be worn when a leak is being repaired. Ammonia solution can be used to detect the leak and a white vapour is noticeable when ammonia and chlorine reacts.

Any failure in the carrier water system will also have a detrimental effect on the disinfection process due to an inadequate supply of the disinfectant (chlorine) being delivered to the point of application. Any such failure will result in inefficient disinfection and a deterioration in microbiological quality.

Changes in the raw water quality can lead to higher disinfectant demand being experienced. This can manifest in a reduction in the disinfectant concentration available for disinfection and in the residual disinfectant concentration of the water. This may result in increased health risks due to water quality variations.

PROCESS AND PLANT INTERVENTIONS

Uncontrollable variables

The most obvious uncontrollable variable to most plants is the raw water quality. Both raw water turbidity and disinfectant demand can change either seasonally or due to storm water influx. Other factors related to raw water quality are the presence of organic carbon and reduced iron and manganese species in the water. All of these parameters can influence the plant operation and steps are required to control and limit adverse impacts.

Actions that can change this to controllable aspects

Various actions can be taken to address these issues.

Dosing regimes. When a change in raw water turbidity is experienced the first step should be to adjust the coagulant dosage to allow effective coagulation and flocculation to proceed despite the change raw water quality. It may even require that the coagulant type be changed under certain circumstances.

Flow changes. Flow changes to the plant are normally required after transient conditions have been experienced. This may only be temporarily to allow steady state conditions to be achieved, but other interventions like increased more frequent scouring of sludge will be required for the duration of the period when higher turbidity is being experienced. The nature of the floc that is formed may however result in increased floc carry-over and this will adversely affect the throughput through the filtration plant. This in turn will result in a higher filter backwashing frequency and should this adversely affect the water production the flow reduction may have to be maintained during the period of high raw water turbidity.

This course of action would normally be a trade-off and the maximum throughput through the sedimentation system should be determined to the point where the filtration plant becomes the limiting factor. The effect of the consumption of backwash water must be considered when the optimum flow is determined. A possible alternative is the selection of other coagulants, or combinations of coagulants, that would result in sludge that settles better to allow the plant to be operated at, or closer to, the design throughput.

The presence of organic carbon and reduced species of iron and manganese in raw water supplies contribute to the oxidation (disinfectant) demand of the water. Apart from this, other impacts associated with these compounds have also been identified. Organic carbon leads to trihalomethane (THM) formation when chlorine is used as a disinfectant while the metallic ions are oxidised to insoluble species that results in discolouring of the finished water. Pre-chlorination results in increased levels of THM but organic material can be removed to a certain extent by effective coagulation-flocculation and sedimentation while a further reduction can be achieved with sand filtration.

The removal of dissolved reduced iron and manganese from water can be achieved by oxidation of the raw water to allow the insoluble oxidised species to be removed together with the suspended matter. Various oxidation methods can be used that should be specified for each plant.

Alternative sources. Most water treatment plants have only one source of raw water. Should a plant be in the fortunate position where an alternative raw water supply is provided it may be expedient to use this when the normal supply changes in quality.

Reporting abnormal circumstances. Where abnormal circumstances may affect either the quality or quantity of the water supplied to consumers, senior management must be informed to allow them to take the necessary steps to alert consumers of the possible impact.

All abnormal circumstances must be reported to supervisory and technical personnel to ensure that the appropriate actions are taken. Any changes to the accepted operating regime must be logged and it must be ensured that all shift personnel are aware of the changes, the reason for it and the expected duration of the change.

Emergency operating procedures. In order to prevent unnecessary experimentation with operating parameters it is advisable to provide detailed operating instructions addressing abnormal conditions whenever possible. Although all contingencies cannot necessarily be addressed using this approach guidance can be provided in a number of cases.

Contingency plans should be in place and available to operating staff alerting them to set procedures to be used when abnormal circumstances arise. Details regarding reporting routes, emergency services and key personnel should be included in these plans.

RECORD KEEPING AND REPORTING

Records must be kept to allow proper plant management and control. Performance records are required for trouble shooting, to identify changes in operating conditions, to identify reasons for process failure or water quality reduction, for process optimisation, to record changes in influent quality and process conditions, etc. A further important aspect of recordkeeping is the availability of data and information for research and design of future expansion to the facility or erection of new facilities using the same raw water resource.

Process flow charts, operating and maintenance manuals and the plant design philosophy should be accommodated in the documentation system. These documents should be available to the relevant personnel and specific requirements must be included in the operating philosophy. Any modifications to the plant must be recorded and the engineering drawings and process flow charts must be updated accordingly.

The mere recording of data without a systematic retrieval system associated with it is a wasted effort. The data must be stored in a system from where it can be readily retrieved and where it is securely stored. Control of the documentation is of the

utmost importance. It must be impossible to change the data and when changes are required it must only be possible under the supervision and direction of an appointed responsible person. Any changes must be highlighted and the original value as well as the reason for changing it must be recorded. When an electronic database is used the file must either be in a PDF format or it must only be available in a “read only” format while access for change must be password protected.

The time that data is stored is a critical part of the management of the record keeping system. This should be based on the purpose that the data is to be used for while legislative requirements must be considered as well. Cognisance must be taken of the requirements of the water use permit or licence regarding data availability and requirements by the authorities before deciding on the time that historical data is to be kept for.

The impact of changing land use, air pollution and groundwater pollution on water resources are long-term impacts. Assessing water quality deterioration due to these factors requires extensive historical data to be available. Raw water quality data may thus require much longer storage periods than normal plant operating data. When new plants are designed these long-term quality changes can be used in a rational design to allow water treatment plants to be operated according to the design specifications over the design life of the facility.

Water services development plans (WSDP) of other service providers may impact on resource allocation, quality of the raw water and even on the abstraction source. The possibility of such impacts should be considered when data collection and storage are being developed.

Catchment management agencies (CMA) can influence decisions regarding development within a catchment. Data on long-term water quality changes can be useful during discussions regarding new developments. The impact of changes on the operating capability of a treatment plant can be substantial and data to substantiate adverse impacts that compromise the production capability of a plant must be incorporated in the databank that is used for long-term data storage.

- Operating personnel should routinely record only that information that is useful in plant operation and troubleshooting. The following data should be recorded as a minimum by the shift personnel:
 - Flow-rate: influent, sludge scouring, filter backwash, chemicals dosage, water production
 - Pressure: pump inlet and outlet
 - Differential pressure: in-line strainers on chemical dosing lines; inlet strainers; filters
 - Number of filters in operation, filtration rate, number of filters washed
 - Levels: raw water storage reservoirs; product water storage tanks; chemical dosing tanks (day tanks); chemical bulk storage tanks; effluent storage tanks. The lubricating oil levels on pumps, gearboxes and blowers need to be checked at least once per shift.
 - Chemical parameters: record all on-line and in-line monitor results. Important aspects in this regard are pH, conductivity, disinfectant concentration etc.

- Physical parameters: record all on-line and in-line monitor results, here turbidity (both inlet and outlet) and temperature are to be recorded. Turbidity should be monitored on intermediate processes like clarification as well as final product. The temperature of lubricating oil systems and bearings on rotating equipment is to be monitored to enable equipment failure to be pro-actively addressed. When abnormalities are noted the monitored oil levels should be checked for possible loss of lubricant.

Certain parameters are normally monitored by analysis in a suitably equipped laboratory. Analytical results must be kept in a secure and controlled database to ensure that data corruption cannot take place.

The parameters analysed can be broadly categorised in three distinct groups, i.e. microbiological, chemical and physical.

- Microbiological parameters monitored will normally include heterotrophic plate count, faecal coliforms, total coliforms and free available chlorine or other disinfectant residual concentration. The latter parameter is added here because this gives some indication of the disinfection efficiency and is thus an indirect measure of the microbiological quality of the finished water. It is important to note that the determination of free available chlorine, or any other disinfectant residual, is only a guide and being an indirect indication of microbiological quality must never be used to replace microbiological examinations.
- Chemical parameters can be subdivided into macro- (mg/l) and micro- (µg/l) constituents or into four categories as suggested by in the Water Research Commission (WRC) publications “Quality of Domestic Water Supplies” Volumes 1 and 3. These four categories are:
 - General indicators. These should be determined frequently at different points in the system.
 - Commonly present and which may lead to health problems and which should be determined before water is supplied. The frequency of determination can be lower because the concentration levels are expected to remain steady unless pollution occurs
 - Less frequently present at concentrations of real concern to health. These substances should be tested where soft water of low pH is used that results in corrosion of pipes and appliances. Fairly frequent checks required in designated areas, but generally required to be analysed quarterly to six monthly.
 - Commonly present at concentrations of aesthetic and economic concern in domestic water sources. Due to the economic impact of this group of substances frequent analysis is recommended.

The frequency of analyses should be determined based on such a rational categorisation.

Category A: Faecal coliforms. Total coliforms. Electrical conductivity. pH. Turbidity.

Category B: Free available chlorine. Arsenic. Fluoride. Nitrate. Nitrite. Sulphate.

Category C: Cadmium. Copper. Zinc.

Category D: Calcium. Sodium. Chloride. Iron. Manganese. Total hardness. Magnesium. Potassium.

Samples taken for chemical analysis must be representative of the source. Any sample that does not fulfil this requirement lead to inaccuracies regardless of the care taken during analysis to ensure that the analyses performed are meeting all quality assurance criteria. Sample containers must be clean, rinsed with water from which the sample is to be taken, and taken from an area where conditions prevail that ensures that the sample is representing the source material. Some general precautions to obtain representative water grab samples must be adhered to in order to avoid sampling errors.

- Samples should be collected below the surface near the centre of the vessel or duct.
- The container must be rinsed several times with the water to be sampled.
- Samples must be collected as close to the source as possible but sufficient mixing must be allowed when mixing of streams, like a carrier stream for chemical dosing, is the area of interest.
- When samples are taken from a sample line the water must run for a sufficient time to ensure that the sample lines were flushed thoroughly. Sufficient time must be allowed to pass 3 to 5 pipe volumes, of the sample line, to facilitate line flushing. Should the dimensions of the sample line be unknown the line should be flushed for 2 to minutes before sampling.
- Sample containers must be filled slowly with a gentle stream to avoid air bubbles and turbulence.
- Grab samples from a river or stream should be taken from the middle of the main channel at mid-depth.
- Sampling from a dam or reservoir poses unique challenges due to stratification, wind action, rainfall and runoff. Samples should be collected from the same area and at the same depth to minimize variations. Avoid disturbance of the bed when sampling to prevent disturbed sediments from entering the sample.

Various procedures can be used to test the accuracy of analyses. These include addition of a known concentration of a determinant, analysis for the determinant and comparison of the result with the known concentration. Although such methods can indicate that accurate analyses have been performed samples that do not conform to the requirements set out above can still result in erroneous data being generated.

TREATED WATER QUALITY

At a potable water production plant the aim must always be to supply water to the consumers that will not be detrimental to their health in both the short and long term. The Department of Water Affairs and Forestry have prepared South African Water Quality Guidelines and these should be studied regarding detailed rationale for the establishment of the allowable concentrations of the various constituents.

All parameters are generally not analysed for at the treatment plant but this does not imply that they should not be included in routine periodic analysis of the water produced. The list should be considered as a guide and detailed requirements should be obtained from the source document.

Quality parameters for plant or process control

Quality parameters for plant control are dependent on the design and condition of the plant. The following criteria can be used as target values that should be readily attained in a well-operated plant.

Coagulation: Coagulant dosing as specified. Influent rate as per specification. Flash mixing as required.

Flocculation: Sufficient floc formation.

Sedimentation: Turbidity < 4 NTU. Flow rate not excessive.

Sludge removal: Removal rates checked for efficiency. Removal systems to be checked for correct operation.

Filtration: Turbidity < 0,5 NTU. Differential pressure within set limits.

pH adjustment: pH as required, pH adjustment dose rate.

Fluoridation: Dose rate to be checked to prevent over dosing of water (target 0,7 mg/l)

Disinfection: Required residual (Chlorine > 0,5 mg/l), or as determined through microbiological determination). Injection equipment operational. Leak detection equipment operational. Personal protective equipment serviceable.

Chemical dosing: All chemical tank levels sufficient to allow successful operation. All dosing pumps operating effectively. In-line strainers differential pressure within allowable limits.

Bulk chemicals: Sufficient stock available to allow continuous plant operation. Possible spillages to be rectified.

Pumps: Delivery and suction pressures of pumps must be recorded. Oil temperature of lubrication systems to be recorded. Oil levels of pumps and gearboxes to be checked. Starting sequences and starting of pumps to be done according to operating instructions. Instances of water hammer to be recorded and investigated.

Reservoirs: Reservoir levels to be checked routinely. Sedimentation in storage reservoirs occurs. When the level of potable water reservoirs is allowed to drop very low entrainment of sediment may occur resulting in poor quality water supplied to consumers. Where raw water reservoirs are installed the levels must be checked to ensure adequate supply of raw water is available.

LABORATORY AND INSTRUMENTATION

The laboratory should be spacious enough to accommodate all equipment to be used. Sufficient lighting must be supplied to allow colour changes to be clearly visible when titrations are done. Ergonomic considerations must be observed during the design and layout of a laboratory.

Storage facilities for samples must be adequate. In this regard storage space must be available but it is important to note that certain samples need to be kept at a temperature below 4 °C. This can be achieved by using either a refrigerator or a cold room. It must be stressed that good laboratory practice preclude the simultaneous use of such facilities for the storage of food and drink for human consumption. The cold storage facilities must thus be used exclusively for the storage of samples and chemicals when the latter are to be stored at low temperatures.

Sample containers can be made of a variety of materials. The best, but also most expensive containers are made of PTFE (Teflon) but these containers only need to be used under special circumstances. The least expensive containers are made of polypropylene or polyethylene. Glass containers can also be used. They are however, fragile and soft glass containers can result in incorrect results being obtained when metals in the micro-gram per litre range are to be determined. In general polyethylene or glass containers can be used with confidence to take all samples, except for special analyses for which the type of container must be specified.

Instrumentation is a wide and specialised field and only general guidance is provided. Critical plant parameters must be identified when a rational monitoring scheme is being planned and the appropriate instrumentation to support the monitoring must be installed. It is advisable to install online instrumentation as far as possible (if it can be afforded) rather than relying on periodic grab samples to monitor a process.

The critical process physical variables like flow to the plant, suction and delivery pressures of the various pumps, differential pressure over the sand filters and any strainers as well as the flow rate through the various unit processes need to be monitored. Conductivity gives a good indication of the dissolved solids concentration in water and when appreciable variation in this parameter is expected (as an indication of changes in raw water quality) this parameter should be included in a monitoring system. When a wide range of raw water turbidity is expected from the raw water source, proportional coagulant dosing control can be achieved by using a streaming current detector with the output being used to control the coagulant dose rate (although the effectiveness of this is method is questionable).

Apart from the above, chemical variables like pH and free and available chlorine should be monitored routinely. From a health and safety perspective chlorine leak detection systems need to be in place at the bulk gaseous chlorine cylinders. This equipment needs to be tested regularly to ensure correct functioning.

Laboratory equipment requirements are site specific and mainly dependant on the analysis required in the laboratory. Equipment that are considered to be essential are:

- Fume cupboard
- pH meter
- Conductivity meter
- Turbidity meter
- Comparator for chlorine determination using DPD reagents
- Analytical balance
- Drying oven
- A visible range spectrophotometer is useful but not considered essential
- A variety of glassware is required for titration and dilution:
 - ▣ Pipettes 1, 2, 5, 10, 20, 25 and 50ml
 - ▣ Burettes 50 mL and possibly a 10 mL microburette.
 - ▣ Erlenmeyer flasks 250 and 500 ml
 - ▣ Standard flasks 50, 100, 250, 500 and 1 000 ml
 - ▣ Glass beakers 50, 100, 400, 500 and 600 ml
 - ▣ Funnels
 - ▣ Equipment for vacuum filtration
 - ▣ Filter paper
 - ▣ A few wash bottles to use with distilled or demineralised water
 - ▣ A glass still to produce distilled water or a laboratory deioniser.
 - ▣ Tongs to handle heated equipment

Where more sophisticated analyses are required routinely, the equipment may be upgraded to enable routine analyses of a large number of samples to be done within a limited time period. When this approach is taken the following equipment may prove to be useful:

- Atomic absorption spectrophotometer or
- Inductively coupled plasma (ICP)
- UV visible spectrophotometer in place of the visible range one
- Auto titrator
- Heating mantles or digestion blocks
- Distillation is required during certain analyses. Should such analyses be required heating mantles, coolers and associated flasks and connectors must be part of the laboratory equipment.

When microbiological analyses are to be done in a laboratory the necessary equipment must be available. The following equipment is considered to be essential additions to the laboratory equipment already listed:

- Autoclave
- Laminar flow cabinet
- Microscope
- Bunsen burners
- Sample loops
- Microbiological sample bottles
- Test tubes
- Petri dishes
- Required agar and growth medium
- Water baths at 44,5°C
- Hot air incubator at 37°C

The work area should be made from material that can be readily decontaminated and it is recommended that the air to the microbiological laboratory should be supplied by a dedicated air conditioner that incorporates air filtering to the required standard. This should assist in maintaining clean conditions in the laboratory and prevent any bacterial contamination of the adjoining laboratories.

Safety precautions must be adhered to and apart from personal safety equipment required by law, safety showers and eyewash stations must be provided in the laboratory. Disposal of laboratory reagents and analysis residue must be done responsibly and to the correct disposal site.

Laboratory chemical requirements

The selection of laboratory chemicals is based on good laboratory practice. The accuracy of an analysis is often affected by the quality of the reagents used. In order to minimise the risk of adverse effects by reagents, the best grade reagents that is affordable must be used. In this regard analytical grade reagents, or equivalent, should be used for the preparation of solutions. The quality of the water used is also extremely important and the water used must not contain any impurities that interfere with the analytical method used. In this regard deionised water is generally preferred to distilled water although the later can give satisfactory results for most analyses.

Chemicals should be bought in the smallest quantity practically usable in a relatively short period to minimise the possible deterioration of the material on the shelf. Reagent bottles that are opened can absorb water vapour or carbon dioxide or can be oxidised by air. Others may be light or temperature sensitive that may lead to deterioration. All such influences can have a detrimental effect on the quality of analysis performed and the necessary precautions must be taken to eliminate them. It is a good practice to label all reagent bottles with the date purchased and to discard it safely when the expiry date is reached. In order to determine such dates the advice of the reagent suppliers can be of value. Reagents that are made up to use in specific analyses may also deteriorate with time and the appropriate expiry date must be noted on the label. Even when prepared standard solutions are bought from suppliers the quality of the solution cannot be assumed to remain unchanged with time and an expiry date should be inserted on the label.

Changes in the concentration of solutions can occur due to absorption of gases from the atmosphere, e.g. caustic solutions absorb carbon dioxide and the hydroxide ion concentration is reduced and easily oxidisable solutions like ferrous ammonium sulphate is oxidised by air and the ferrous ion concentration reduced. Precautions can be taken to minimise the effects but daily standardisation of such chemicals will improve the quality of analysis.

Contamination of reagents can be minimised by taken certain simple basic precautions. In this regard it is important to ensure that no reagent bottle should remain open for longer than necessary. Solid material should be transferred to a watch glass or beaker prior to weighing without the use of a spatula to remove the material from the bottle. Liquid reagents should be poured into a beaker and not removed from the container by a pipette. The minimum quantity of material should

be removed to minimise losses and to prevent unnecessary disposal of the spent material. No material should be returned to the container after removal.

No water laboratory should use informal methods of analysis and only standardised methods must be used. Any well-equipped water laboratory should have a standardised method document that must be used by all analysts. In the compilation of such a document extensive use can be made of standard work like “Standard Methods for the Examination of Water and Wastewater” published by the American Public Health Association, American Water Works Association and Water Environment Federation.

SAMPLING AND ANALYSIS

The importance of representative sampling has been discussed earlier. Sample points must be chosen to ensure that this aspect is effectively addressed. Whenever the addition of a chemical compound is done where there is insufficient mixing, the sample should be taken at least 10 pipe diameters from the point of addition. Where this is not possible the maximum distance that can practically be used should be allowed between the dosing and sampling points.

The frequency of analysis is dependant on raw water variability and the impact that various treatment chemicals may have on the consumers and plant performance. In this regard the health impact of fluoride and the adverse impact of too little disinfectant on consumer health are good examples. Regarding plant performance the adverse impact of under- and overdosing of coagulant on turbidity removal can be used as illustration.

Various processes require different parameters to be monitored. The required frequency of analysis is not the same for all processes and even different parameters recommended for analysis, to be able to control a process, need not be done at the same frequency.

Sample points are to be established, installed where practical and marked appropriately. This will ensure that samples are taken at the same place and will not be dependant on human factors. Sample containers are to be marked to prevent possible cross-contamination and sampling errors are thus minimised.

When metal salts are used as coagulants a reduction in alkalinity is experienced. The difference in alkalinity between the raw water and the coagulated filtered water alkalinity can be used to determine the coagulant concentration dosed. The pH of the coagulated water may also be reduced but this will be dependant on the buffer capacity of the raw water and is not as good an indicator as the differential alkalinity.

Flocculation efficiency can be established by visual inspection where floc formation is observed. When the flow-rate through the sedimentation basin is within design parameters the turbidity of the basin overflow will give a good indication of the flocculation efficiency achieved.

Filtration is aimed at the removal of solid particle from the water. When the water is flocculated effectively the filtration plant should remove any flocculated material

carried over from the sedimentation section. Extensive carry-over of floc will result in shortened filtration run lengths and early breakthrough will result. The turbidity of the individual filters must be established to prevent the masking of a breakthrough on an individual filter by a number of filters producing acceptable water quality.

The purpose of disinfection is to render a product water that conforms to microbiological quality criteria for potable water. Sufficient disinfectant must be added to achieve this aim. When chlorine is used a residual free or available chlorine concentration of 0,5 mg/l should be detected in the water after 10 minutes retention time.

Stabilisation of water is done to render the water non-corrosive and to reduce the scaling potential of the water. Adjusting the pH of the finished water normally achieves this and when soft raw water is used the addition of $\text{Ca}(\text{OH})_2$ can also be used. The scaling potential of the finished water should normally be maintained at about 4 mg calcium carbonate/l. In order to calculate the CCPP the pH, conductivity, calcium hardness, total hardness, sodium, sulphate and chloride are required as input to the Stasoft program that can be used to calculate the calcium carbonate precipitation potential. Less eloquent indices of stabilisation of water are the Langelier or Ryznar indices that yield results expressed as a number (value). The inputs required are pH, conductivity, calcium hardness and alkalinity.

Fluoridation of water supplies is done primarily to prevent dental caries in the consumers. Too high fluoride concentration in the water can however lead to staining of teeth and in severe cases even to the development of brittle bones in the skeleton that can break easily under mild stress with crippling effects on affected individuals. When fluoridation is practised at a water treatment plant the objective is to ensure that the correct concentration is maintained. The allowable fluoride concentration is dose dependent and the more water an individual consumes the lower the allowable concentration is. It is customary to express the recommended fluoride concentration as a function of the average daily temperature to compensate for higher individual water consumption in hotter climates.

Water treatment sludge consists of the suspended particles removed from the water and the active part of the coagulant used, all suspended in water. The dilute suspension can be treated further by a thickener, centrifuge, filter- and belt-presses or on sludge drying beds. Disposal to sludge lagoons is also commonly used and in all instances it would be possible to recycle the separated water to the inlet works. The concentration of the solids in the sludge blow-down stream is dependent on the sedimentation system but low solid concentration in the sludge should be avoided.

The following table gives an indication of sampling required and determinants to be analysed for

Process	Sample point	Parameter	Frequency	Recommended maxima
Coagulation	After rapid mixing	pH Alkalinity	Daily Daily	Site specific Site specific
Flocculation	After sedimentation	Turbidity Visual observation of floc formation	Shift Every shift	
Sedimentation	Basin discharge	Turbidity	Shift	< 2 NTU
Filtration	Individual outlet	Turbidity	Shift	< 0,2 NTU
Disinfection	After contact zone	Disinfectant residual	Shift	Dependant on disinfectant
Stabilisation	After pH adjustment	pH Conductivity Alkalinity Calcium Total hardness	1/shift	CaCO ₃ precipitation potential 3 to 4 mg CaCO ₃ /l
Fluoridation	After chemical addition and mixing	Fluoride	Daily	Site specific
Sludge treatment and disposal	Sludge	Settlable solids % m/v	Weekly	Site specific

CHAPTER C3: MAINTENANCE AND TROUBLE SHOOTING

Frik Schutte

INTRODUCTION

It is impossible to list all the possible operational problems that could arise at a water treatment works. The main problem areas are related to poor design, variations in raw water quality, lack of maintenance, inadequately trained operators, inadequate process monitoring, poor record-keeping and poor management. A selection of typical problems is discussed below.

Raw water quality changes can occur due to a number of reasons:

- If raw water is abstracted directly from a river, sudden dramatic changes in raw water quality can occur as a result of heavy downpours in the catchment.
- High rainfall in the catchment of a dam can replace the full dam volume in a short period also resulting in rapid raw water quality changes, both these events can cause high turbidity in the raw water.
- Raw water quality can deteriorate due to very low inflow into a dam or river. This can cause the nutrient levels to rise, resulting in eutrophication and algal blooms.
- Algal blooms eventually result in algal decay and release of taste- and odour-causing substances in the raw water to a treatment plant.
- Eutrophication may also result in blooms of diatoms that are not removed in the sedimentation process and are retained on the sand filter beds. This may result in shorter filter runs and a drop in plant output. This may also cause high chlorophyll levels and possible THM formation.

Lack of maintenance is the most common reason for plant failure. Mechanical equipment requires regular attention to ensure problem-free operation. Maintenance schedules must be strictly carried out. Good house keeping and keeping equipment, buildings and civil structures clean and tidy go a long way to minimise operational problems.

Poor operational practice is also one of the main causes of problems on treatment plants. It is imperative that operators understand why they are performing certain tasks and what the consequences are if the tasks are not carried out as prescribed. It is the responsibility of a treatment plant manager to ensure appropriate training of the operating staff.

RAW WATER INTAKES AND SCREENS

Raw water intake gates and screens are simple mechanical devices and are easily maintained. The purpose of the raw water intake is to selectively withdraw the best available quality water from a surface water source. Intakes typically consist of a structure and gates to control the withdrawal of water.

The quality of raw water in a dam or impoundment normally varies with depth. Generally certain stratified layers can be distinguished, i.e. a surface layer, a bottom layer and an undefined layer in between.

The **surface layer** may contain high algal concentrations and even layers of algal scum in eutrophied dams. The algal concentration can be judged by counting algae cells, or by determining the pigment chlorophyll concentration. The Secci-disc depth, i.e. the depth at which a standard Secci disc can still be seen gives an indication of sunlight penetration into the water. In clear oligotrophic (low nutrient concentration) dams the secci depth could be as deep as 10 m or more. In eutrophied dams or turbid water it may be as low as a few mm. If possible, the abstraction depth should be lowered when excessive algae are present so as to avoid abstracting algal-laden raw water.

The bottom layer or hypolimnion often has a low dissolved oxygen (DO) concentration and this gives rise to reducing conditions with reduced Fe^{2+} and Mn^{2+} present and sometimes also gasses such as methane and hydrogen sulphide H_2S . With low DO concentration in the bottom layer the lower intake gates should not be opened to avoid withdrawing water from the hypolimnion.

Logs and debris lodged near the intake may be an indication of excessive intake velocities. Some accumulation may be unavoidable in most cases, but can be minimised by reducing intake velocities. This can be achieved by opening additional gates.

The main function of **screens** is to remove suspended material from water to protect pumping and other equipment. If screens are not properly maintained, serious damage can be caused to pumping equipment. Fine screens are provided ahead of the pumps at the raw water pump station.

Excessive head loss is indicative either of improper cleaning or of slime growth on the screen. Repair cleaning system if it is faulty or improve cleaning procedures to prevent slime build-up.

Large debris can jam travelling-screen mechanisms. These mechanisms are typically equipped with overload protection, which will inactivate the screen during overload conditions. To correct this problem, remove debris and reset motor.

Preventative maintenance and operating procedures that are necessary to ensure satisfactory operation, include:

Intake:

- Operate gates through one cycle at least once a month
- Clean debris from the intake area when need arises or at least six times per year

Fine screens and microstrainers:

- Monitor head loss through screens continuously
- Lubricate bearings as scheduled
- Check cleaning systems periodically
- Remove screenings daily and dispose of it in an approved landfill.

Raw water meters must be calibrated so that an accurate indication can be obtained of the volume of water that is abstracted and treated. This will also assist to optimise treatment processes.

COAGULATION-FLOCCULATION

Effective coagulation and flocculation are critical to the successful operation of subsequent treatment processes. Problems associated with the coagulation-flocculation process result in high turbidity water in the overflow of the sedimentation tank and/or the filtered water.

High effluent turbidity from the sedimentation tank, with no floc carry-over is normally the result of poor coagulation-flocculation. It can be the result of too little coagulant or of incomplete dispersion of the coagulant. Perform jar tests with varying coagulant dosages, coagulant dilutions, and rapid-mix intensities. Make adjustments as indicated by the tests.

High effluent turbidity from the sedimentation tank can also result from raw water that has low initial turbidity. An insufficient number of particle collisions during flocculation will inhibit floc growth. Increase flocculation intensity, recycle sludge, or add bentonite to facilitate floc formation.

High effluent turbidity from the sedimentation tank with floc carryover is an indication of a poor-settling floc. High flocculation intensity will often shear floc and result in poor settling. Lower the flocculation intensity, or add a coagulant aid that will produce stronger aggregates that will settle more readily.

Too much coagulant will often result in re-stabilisation of the colloids. If unsatisfactory performance is obtained, run a series of jar tests with various coagulation dosages and adjust dosage rates accordingly.

Calcium carbonate precipitate will often accumulate on lime-feed pipes. Flush lime pipes with an acid solution periodically to dissolve the CaCO_3 scale or use collapsible pipelines or HDPE pipelines with a smooth wall from which the CaCO_3 can be easily removed.

Improper feed rate of coagulant through positive-displacement metering pumps can be the result of siphoning through the pump. Locate pumps in such a way that a positive head is present at all times on the pump discharge. An alternative correction method is to install a back-pressure valve on the pump discharge.

Preventative maintenance and operating procedures

- Perform jar tests on raw water samples when significant raw water quality changes occur. Adjust coagulant dosages and mixer speeds accordingly.
- Clean accumulated precipitate and sludge from rapid-mix and flocculation basins when need arises or at least every six months.
- Calibrate chemical feeders every month.

- Check the chemical analysis of each delivery of coagulant. Adjust feed rates as indicated by the analysis and jar tests.

SEDIMENTATION

Sedimentation can typically remove 80 to 95% of suspended solids and will result in better filter performance and longer filter runs. However, performance of a sedimentation basin is dependent on effective coagulation-flocculation.

Operational problems associated with sedimentation basins typically relate to ineffective sludge removal or short-circuiting. Ineffective sludge removal commonly is associated with equipment problems or inadequate sludge removal practices. Short-circuiting is typically the result of poor inlet or outlet design. Short-circuiting can also be the result of wave action, density currents, hydraulic overloading or temperature currents.

Preventative maintenance and operating procedures

- High effluent turbidity or floc carryover may result from problems with the coagulation-flocculation process. Conduct jar tests to determine correct dosage and adjust dosages if necessary. Ensure correct functioning of mixing and coagulation processes.
- High turbidity or floc carryover may also result from short-circuiting in the sedimentation basin. Perform tracer studies and make corrections. Possible corrective measures include installation of inlet baffles.
- Operational problems with sludge collection equipment may include shear-pins or motor overloads, both generally due to improper sludge removal. Check for proper shear-pin installation and motor overload setting. Remove sludge more frequently and check for large debris in the basin.
- Sludge withdrawal with low solids concentrations may result from an excessively rapid removal rate or from a sludge collection mechanism that is not operating properly. Decrease the removal rate, and check the operation of sludge collection equipment.
- Clogged sludge withdrawal piping can be the result of insufficient sludge withdrawal from the sedimentation tank. Increase the removal rate and frequency.
- Algae build up on basin walls or weirs may create taste and odour problems. Clean basin walls on a regular basis.
- Sludge with a high organic content may impart taste and odour problems to the finished water. Increase the sludge removal frequency.
- Clean basins annually to remove any accumulated sludge and algae growth.
- Lubricate sludge collection equipment as recommended by the manufacturer.
- Test the sludge collection overload devices annually.
- Test the solids content in the sludge withdrawal line daily.
- Test turbidity of effluent on a regular basis and whenever the water quality or flow rate changes.

SAND FILTRATION

The sand filtration aspects are discussed in detail in the sand filtration chapter.

ACTIVATED CARBON ADSORPTION

Proper operation and regularly scheduled maintenance of powdered activated carbon systems are essential to provide uninterrupted service.

PAC feed systems

Operation and maintenance of the colour, taste and odour removal systems depends on the raw water quality. PAC systems are only operated during periods of poor raw water quality when taste and odour causing compounds are present. During periods of poor quality, these systems will require additional operator attention. Routine maintenance should be scheduled to ensure that equipment is not allowed to deteriorate when not in use. The following procedures are recommended for satisfactory operation of the facilities.

- Monitor final water quality to detect colour, taste and odour problems. Adjust chemical dosage rates when necessary, or put the potassium permanganate and/or PAC systems into operation when water quality goals are not met.
- Verify dosage settings and record feed rates daily. Maintain a log of feed rates, together with raw and treated water quality parameters, for comparison. This log should be reviewed periodically to detect trends and relationships that might guide in future operator decisions.
- Calibrate chemical feeders regularly. Verify proper operation of pumps, hoppers, feeders, mixers, scrubbers, piping, valves and instrumentation.
- Lubricate, clean and service equipment as specified by the manufacturer.
- Flush the PAC lines weekly when they are in service, monthly when they are out of service. Verify and make sure that the airlines and sparge for the PAC systems are not clogged.
- While the PAC is being used, ensure that there is no breakthrough of fine particulate PAC through the sand filters
- Ensure that PAC that had been in storage for a long period has not formed clumps that will cause problems to bring it into suspension

STABILISATION

Operational problems associated with stabilisation systems are mainly associated with problems with liquid or dry-chemical feeders.

Check the stability of water daily. Use the Stasoft program to calculate the Calcium Carbonate Precipitation Potential (CCPP). In addition, check the stability of water when the quality of the raw water changes and when chemical doses or treatment processes are modified. Adjust chemical feed as necessary.

SLUDGE MANAGEMENT

Residual streams from water treatment processes are treated and disposed of in different systems depending on the source and type of residual and the ultimate mode of disposal. The different processes vary from simple thickening to relatively sophisticated mechanical dewatering devices such as belt presses and centrifuges. The main objective is to recover and recycle water from waste streams and to reduce the volume of sludge to be ultimately disposed of.

The main items that may be used at a water treatment works include:

- Gravity thickener, to thicken the sludge from sedimentation
- Filter backwash water surge tank and recovery basins to process filter backwash water and thickener overflow
- Sludge lagoons, for dewatering and on-site disposal of solids.

Proper operation and maintenance of these facilities are important for water recovery and sludge disposal.

Backwash water recovery basin

The backwash water recovery basin is typically a circular gravity-settling basin. Poor-quality supernatant is an indication of non-settleable colloidal particle in the filter backwash or in the thickener overflow. Flocculant feed ahead of the recovery basin should be used to enhance flocculation and sedimentation.

Sludge solids uniformly overflowing the weir may be due to inadequate removal of thickened sludge. Check the sludge pumps and piping for malfunctioning or blockage. Increase sludge withdrawal to maintain at least a 2-m clear water zone in the basin.

Low solids in the sludge may be due to excessive sludge withdrawal, short-circuiting or surging flow. Reduce sludge withdrawal, check and install baffles and modify influent pumping rate.

Sludge solids discharging over the weir in only one portion of the basin can be the result of unequal flow distribution. Level the effluent weir.

Gravity thickeners

Rising sludge in the thickener is generally due to low or infrequent thickened underflow pumping rate, low thickener overflow rate, or too high sludge blanket level. The problem can be overcome by withdrawing thickened sludge more frequently or by addition of dilution water for increased hydraulic loading.

Too low underflow sludge concentration may be due to a high overflow rate, a high underflow withdrawal rate, or short-circuiting through the tank. This could be rectified by reducing the influent sludge flow rate, by reducing the underflow withdrawal rate and by maintaining a high sludge blanket. Uneven discharge of solids over the effluent weir could be an indication of short circuiting through the thickener. Weir levelling or a change in baffle arrangements may be necessary.

Torque overload of sludge-collecting equipment can be due to accumulation of dense sludge, too high sludge bed, too high sludge concentration or to a heavy foreign object jamming the scraper. The problem might be solved by agitation of the sludge blanket in front of the collector arms by rods or water jets.

Plugging of sludge lines and pump may be due to a too thick sludge or debris in the sludge lines. The lines should be flushed and all valves should be opened fully. Screens must be in place to remove debris before it is pumped to the thickening equipment.

Sludge-drying lagoons

The seepage/filtration rate will decrease with time as a result of build-up of solids over the sand layer. If the drying rate is reduced significantly, surface preparation will be necessary. This is achieved by tilling the sludge layer or by forcing holes through the sludge layer into the sand.

Filter backwash water surge storage tank

Settling of solids in the surge tank is expected under normal operating conditions. Excessive build up of solids can cause reduction in pumping capacity. Check the pumps and the suction piping daily and remove all settled solids.

The pumps should be operated alternately, on a regular basis, for uniform wear. Both pumps will operate when the liquid level in the surge tank exceeds a preset high level. Liquid-level controller and pump operation should be checked routinely for emergency operation.

Check polymer-feed system and equipment in flocculation units.

Debris may accumulate in the recovered filter wash water lines. Screens must be installed to remove the debris before it is pumped to wash water treatment equipment or recycled to the treatment plant.

Backwash water recovery basin

- Check polymer feed system and equipment in flocculation units.
- Remove accumulations from the influent baffles, effluent weirs, scum baffles and scum box each day.
- Determine sludge level and adjust sludge pump as necessary.
- Clean daily all inside exposed vertical walls and channels.
- Inspect the distribution box and clean the weirs, gates and walls as necessary, and remove all settled solids.
- Inspect the effluent box and clean the weir and walls as necessary. Measure the head over the weir routinely.
- The overflow pumps should be operated alternately, on a regular basis, for uniform wear.
- Drain the basin annually, to inspect the underwater portion of the concrete structure and mechanism. Inspect the concrete structure and patch defective areas.

Gravity thickener

- The overflow pumps should be operated alternately, on a regular basis, for uniform wear.
- The sludge feed and under flow pumps should be operated alternately, on a regular basis, for uniform wear.
- Clean all vertical walls and channels by broom or squeegee daily, and hose down walls regularly.
- Check the sludge level daily. The sludge should be kept well below the top of the thickener. Sludge wasting should be controlled to maintain a proper sludge blanket.
- Daily, check electrical motor for overall operation and bearing temperature. Check the overload detector and monitor unusual noises.

CHAPTER C4: SAFETY

Frik Schutte

INTRODUCTION

Safety requirements are stipulated by the Occupational Health and Safety Act (Act 85 of 1993). Under the Act, responsibility for unsafe conditions or procedures now devolves to the chief executive or highest level of an operating authority and it is not unusual for the manager to be prosecuted for an accident that took place on the works under his/her control. It is thus important that all operations comply with the requirements and spirit of the regulations.

The National Occupation and Safety Association (NOSA) strives to cultivate an awareness of safety and safe working procedures in the work place. The future of this organisation is however, uncertain and future developments will indicate what will follow. It is strongly recommended that management makes contact with NOSA or the future organisation in order to get expert opinion on their own operations.

HAZARDOUS CHEMICALS

Water Treatment Works personnel are often exposed to hazardous chemicals during their daily operational activities. Chemicals such as chlorine (liquid, gas and pellet form), ferric chloride, lime and other chemicals should be handled with care, as these materials are harmful and can be toxic, strongly acidic and irritating on the skin. Specific safety training must be given to all staff who could be exposed to such materials.

Proper masks and protective clothing should be worn during normal handling. In the case of spillages or leakages, proper procedures to handle such spillages must be in place.

It is strongly recommended that if chlorine gas is used at the works that the chlorine supplier be requested to conduct a training programme on site so that all personnel involved in chlorination and handling of containers be well aware of all the necessary safety procedures.

Where off loading or handling of ferric chloride and other liquids used for coagulation takes place, the necessary emergency showers and eye-wash facilities must be provided.

The abovementioned chemicals are typical chemicals used in the conventional water treatment process. In the case of advanced treatment processes brine solutions, and specific chemicals for regeneration of ion exchange resins could be encountered and attention must be paid to the chemical suppliers handling and care instructions.

SAFETY COMMITTEES

In terms of regulations framed under the Occupational Health and Safety Act, Act No. 85, one safety representative must be appointed in writing at any workplace for every 50 persons employed, except where there are less than 20 employees (farm labourers are excluded). It is mandatory for this safety officer to carry out at least one inspection per month of the workplace to which he/she has been designated. The safety officer must report any threat or potential threat to the health and safety of any employee to his employer or any safety committee established in terms of the Act.

In large undertakings, the various safety representatives would form a safety committee. At smaller installations it is suggested that such a committee should include the engineer or responsibility person duly delegated by the Chief Executive Officer, the works manager, the maintenance foreman, a senior process controller, a labour representative and the safety officer. Small works should at least be served by the engineer or responsible person, the superintendent or process controller, and representatives from maintenance and the labour force.

Meetings should be held on a routine basis or the entire purpose of the committee is lost. The committee's functions are to promote awareness of safety, investigate accidents, recommend safe practices and procedures, and to ensure compliance with statutory requirements.

BASIC SAFETY RULES

All persons visiting or employed on a water treatment works should observe the following basic rules at all times:

- Do not smoke or use an open flame on the works except in those areas that have been designated as safe.
- Do not touch electrical equipment or switches and treat all equipment that has not been isolated and locked as live.
- Do not touch moving machinery.
- Take care when standing near or working over tanks and channels where there may be deep or swiftly moving water.
- Ensure all moving machinery parts are adequately guarded.

SAFETY EQUIPMENT

Each works should be equipped with the following items - quantities of each item will depend on the number of people employed on the works:

- Spark proof tools.
- Symbolic safety signs.
- First aid kit.
- Barricades, traffic cones, flashers and warning signs.
- Fire-fighting equipment to suit each area.

PROTECTIVE CLOTHING

The items listed below make up the necessary basic Personal Protective Equipment (PPE) for all those employed on a works: (Records of the issues must be kept and signed for by the worker)

- Hardhat - made of high-density polyethylene.
- Overall - elastic in cuffs and in the waist and having a zip front.
- Gumboots - lightweight with built-in toe protection and non-slip soles.
- Boots, leather, ankle protection type with toe protection and non-slip soles.
- Gloves made of strong flexible PVC with roughened palm.
- Oilskins.
- Earmuffs - if working in a blower room or similar noisy area.

In addition to the above, those who are involved in workshop activities should have:

- Earmuffs.
- Appropriate goggles, gauntlets, etc. for use during welding, grinding and cutting operations and handling of chemicals.
- Workshop gloves made of soft, flexible leather or pigskin with fingertip and knuckle protection.

Those involved in laboratory work require:

- Acid-resistant dustcoats.
- Goggles
- Unlined neoprene gloves.

SUPERVISION

There is no point in equipping a works with all the recommended safety equipment and the personnel with protective clothing, if the equipment is not maintained and is allowed to deteriorate. A fire extinguisher, which does not work, is worse than no extinguisher at all. The safety equipment should be stored in an accessible position, outside the hazardous area.

Similarly, there is no point in drawing up a safety manual and recommended procedures if they are not followed.

The works manager, superintendent or responsible person must therefore ensure that procedures are adhered to, that ladders, fire extinguishers and respirators are inspected and tested on a routine basis, and that protective equipment such as earmuffs and eye protection, which are often not used, are in fact worn when necessary.

Machinery

- When working on a piece of equipment, ensure that it cannot be started or operated either by isolating at the panel and/or the local stop, or by disconnecting the means of starting.

- Always use the correct tools for the job.
- Keep chisels in good condition.
- Wear visors or goggles when grinding.
- Use correct grade of protective visor or goggles when welding or brazing.
- Do not manhandle heavy objects. Use lifting gear.
- Always replace belt guards and other safety shields.
- Always read the instructions carefully before carrying out any maintenance operation on a specialised piece of equipment.

Electrical

- No unauthorised person shall work on electrical equipment, open a panel or enter a substation.
- All equipment that is to be worked on shall be properly isolated and locked so that it cannot be switched on. Suitable notices shall be placed at the switch panel and adjacent to the equipment.
- All installations shall be properly tested by a competent person before being put back into service.

Materials handling

Care should be taken in handling heavy or bulky objects. In order to reduce the number of injuries caused by the use of incorrect material handling methods, the following points should be considered:

- Use suitable lifting gear wherever possible.
- No person should attempt to lift more than can be handled comfortably.
- Wear protective gloves as a general rule. Otherwise ensure that the hands and the object are clean and not slippery, and that it is free of jagged edges, metal slivers, nails, burrs and splinters.
- Ensure firm footing and good visibility whilst manoeuvring.

Laboratory safety

Glassware: Gloves must be worn when setting up glass apparatus, cutting tubing or attempting to open tightly stoppered bottles. Chipped and cracked glassware must be discarded. Bottles must not be carried by their necks. Use copper gauze when heating glass vessels using gas flames.

Gas: Gas cylinders must be stored in well-ventilated areas outside the laboratory, or well away from heat if in the laboratory. Double check that the gas is properly closed off after use. If there is a smell of gas in the laboratory open all doors and windows and operate all ventilation equipment. Identify the cause of the leaks if possible, and isolate. Otherwise evacuate the laboratory and obtain specialist assistance.

Chemicals: All containers with chemicals must be marked clearly as to their contents and possible hazard. Solvents must be stored in explosion-proof containers in a suitably ventilated place. Acids must be separately stored in an area where spillage can be dealt with. Rubber aprons, face shields, gloves and acid-resistant dustcoats

must be used when working with dangerous chemicals. There must be an emergency shower with a control valve that can be operated quickly by means of pulling on a chain, a short movement of a lever or stepping on a mechanism to open the control valve.

Electrical: All electrical equipment must be explosion proof and properly earthed. Earth leakage equipment must be installed on the laboratory supply.

Safety and fire hazards: Certain chemicals such as ammonia, nitric, acetic and perchloric acids can react violently with some organic chemicals giving rise to the possibility of fire or explosion. Many volatile solvents are inflammable. When working with solvents the work must be carried out under a ventilation hood. Suitable fire extinguishers must be available at accessible points. A first-aid kit must be kept in the laboratory.

Procedures: Suction bulbs must be used on pipettes for dangerous chemicals. Tongs and asbestos gloves must be used when handling heated samples. Spillage must be cleaned up immediately. Hands should be washed with soap and hot water before eating or smoking. Smoking or eating must be prohibited in the laboratory.

SAFETY LEGISLATION

All water treatment plants must comply with the provisions of the Occupational Health and Safety Act (Act No. 85 of 1993) and any amendments and regulations relating thereto.

The regulations amongst other things provide for the following:

- Depending on the total size of machinery power installed, the works may be required to be under the responsibility of a certified engineer or a designated responsible competent person. Delegations will be made in terms of the Occupational Health and Safety Act.
- The engineer (or responsible person) is responsible to the Divisional Factories Inspector for all safety procedures at the works and can be held responsible for any accidents that may occur through neglect of safe working procedures.
- The engineer (or responsible person) must also keep all records required by the Act such as registers for lifting gear, elevators, pressure vessels and boilers. He shall also submit accident reports and ensure that any inspections required in terms of the Act on pressure vessels and boilers are carried out timeously.

=====

PART D: REFERENCE BOOKS

The following books have been used as source material for this Handbook. The list contains some general water treatment handbooks. Some of these focus more on design aspects while others are more descriptive and process oriented.

1. American Water Works Association (1999) *Water quality and treatment: A handbook of community water supplies* McGraw-Hill Inc.
2. American Water Works Association, American Society of Civil Engineers (2005) *Water treatment plant design* McGraw-Hill Inc.
3. Quasim SR, Motley EM and Shu G (2000) *Water works engineering* Prentice Hall.
4. Binnie C, Kimber M and Smethurst G (2002) *Basic water treatment* IWA Publishing.
5. Cotruvo JA, Craun GF and Hearne N (1999) *Providing safe drinking water in small systems* Lewis Publishers
6. Degremont (1991) *Water treatment handbook* Lavoisier Publishing.
7. Hammer MJ (1986) *Water and wastewater technology* Prentice-Hall.
8. Kerr C (1990) *Community health and sanitation* Intermediate Technology Publications.
9. Loewenthal RE, Wiechers HNS and Marais GvR (1986) 1986. *Softening and Stabilization of Municipal Wastes* Water Research Commission, Pretoria
10. Van Duuren FA (1997) *Water purification works design* Water Research Commission.
11. Haarhoff J and Van Vuuren LRJ (1993) *A South African Design Guide for Dissolved air Flotation*. Water Research Commission, Pretoria.
12. Masschelein W J (1982) *Ozonation Manual for Water and Wastewater Treatment* John Willey & Sons.
13. Pelczar NJ, Chan ECS and Krieg NR (1986) *Microbiology* (5th edition) McGraw-Hill.
14. American Water Works Association (1995) *Standard Methods for the Examination of Water and Wastewater 19th Edition* AWWA.
15. White GC (1992) *The Handbook of Chlorination and Alternative Disinfectants. 3rd edition* Van Nostrand Reinhold New York.

OTHER REFERENCES

American Water Works Association (1987) AWWA Seminar Proceedings. Assurance of Adequate Disinfection, or C-T or Not C-T. *Proceedings: AWWA Annual Conference*, Kansas City, MO

Connell GF (1996) *The chlorination/chloramination handbook. Water disinfection series*. American Water Works Association. ISBN: 0- 89867-886-2

Australian Drinking water Guidelines (1989) *Taste Thresholds of Monochloramine and Chlorine in Water*. Report No WSAA 10

Geldenhuis JC (1978) *Die doeltreffendheid van verskillende suiwerings- en verspreidingsmetodes ten opsigte van die mikrobiologiese kwaliteit van drinkwater*. MSc Thesis Potchefstroomse University for Christian Higher Education

Kruger E (2001) *Water quality deterioration in potable water reservoirs relative to chlorine decay*. Water Research Commission report No 921/1/01 Pretoria

Kruger E, Viljoen J, Lachmann G and Pienaar JJ (2000) Chlorine decay on Concrete Surfaces and Losses to the Atmosphere in Water Storage Facilities *Proceedings Water Institute of Southern Africa. Bi-annual conference*

Masschelein, W J (1982) *Ozonation Manual for Water and Wastewater Treatment* John Willey & Sons

Polasek P (1997). Treatment process efficiencies of South African Waterworks *Water Sewage and Effluent* Vol 17 No. 2, pp. 52 – 56 and Vol. 17, No. 3, 1997. pp. 66 – 68

Potter BB, Wimsatt JC (June 2003) *Determination of Total Organic Carbon and Specific UV Absorbance at 254 nm in source water and drinking water* USEPA, Office of Research and Development, National Exposure Research Laboratories

Public Health Laboratory Services (1982) *The Bacteriological Examination of Drinking Water Supplies* HMSO London

US Environmental Protection Agency (2003) *Determination of Total organic Carbon and specific UV absorbance at 254nm in source and drinking water* National Exposure Research Laboratory US Environmental Protection Agency, Cincinnati, USA

Van der Walt E, (2001) *Water quality deterioration in potable water reservoirs relative to chlorine decay* MSc thesis Potchefstroomse University for Christian Higher Education

Viljoen OJ, Haarhoff J and Joubert JHB (1997) *The prediction of chlorine decay from potable water in pipeline systems* Report No 704/1/97 Water Research Commission, Pretoria

